



High Performance Compact Inverter

# ***FRENIC-Multi***

---

## **CAUTION**

Thank you for purchasing our FRENIC-Multi series of inverters.

- This product is designed to drive a three-phase induction motor. Read through this instruction manual and be familiar with the handling procedure for correct use.
- Improper handling might result in incorrect operation, a short life, or even a failure of this product as well as the motor.
- Deliver this manual to the end user of this product. Keep this manual in a safe place until this product is discarded.
- For how to use an optional device, refer to the instruction and installation manuals for that optional device.

Copyright © 2006-2007 Fuji Electric FA Components & Systems Co., Ltd.

All rights reserved.

No part of this publication may be reproduced or copied without prior written permission from Fuji Electric FA Components & Systems Co., Ltd.

All products and company names mentioned in this manual are trademarks or registered trademarks of their respective holders.

The information contained herein is subject to change without prior notice for improvement.

## Preface

Thank you for purchasing our FRENIC-Multi series of inverters.

This product is designed to drive a three-phase induction motor for fan and pump applications. Read through this instruction manual and be familiar with proper handling and operation of this product.

Improper handling might result in incorrect operation, a short life, or even a failure of this product as well as the motor.

Have this manual delivered to the end user of this product. Keep this manual in a safe place until this product is discarded.

Listed below are the other materials related to the use of the FRENIC-Multi. Read them in conjunction with this manual as necessary.



- FRENIC-Multi User's Manual
- RS-485 Communication User's Manual

The materials are subject to change without notice. Be sure to obtain the latest editions for use.

### ■ Safety precautions

Read this manual thoroughly before proceeding with installation, connections (wiring), operation, or maintenance and inspection. Ensure you have sound knowledge of the device and familiarize yourself with all safety information and precautions before proceeding to operate the inverter.

Safety precautions are classified into the following two categories in this manual.

 <b>WARNING</b>	Failure to heed the information indicated by this symbol may lead to dangerous conditions, possibly resulting in death or serious bodily injuries.
 <b>CAUTION</b>	Failure to heed the information indicated by this symbol may lead to dangerous conditions, possibly resulting in minor or light bodily injuries and/or substantial property damage.

Failure to heed the information contained under the CAUTION title can also result in serious consequences. These safety precautions are of utmost importance and must be observed at all times.

### Application

 <b>WARNING</b>
<ul style="list-style-type: none"><li>• FRENIC-Multi is designed to drive a three-phase induction motor. Do not use it for single-phase motors or for other purposes. <b>Fire or an accident could occur.</b></li><li>• FRENIC-Multi may not be used for a life-support system or other purposes directly related to the human safety.</li><li>• Though FRENIC-Multi is manufactured under strict quality control, install safety devices for applications where serious accidents or material losses are foreseen in relation to the failure of it. <b>An accident could occur.</b></li></ul>

## Installation

### **WARNING**

- Install the inverter on a nonflammable material such as metal.  
**Otherwise fire could occur.**
- Do not place flammable object nearby.  
**Doing so could cause fire.**

### **CAUTION**

- Do not support the inverter by its terminal block cover during transportation.  
**Doing so could cause a drop of the inverter and injuries.**
- Prevent lint, paper fibers, sawdust, dust, metallic chips, or other foreign materials from getting into the inverter or from accumulating on the heat sink.  
**Otherwise, a fire or an accident might result.**
- Do not install or operate an inverter that is damaged or lacking parts.  
**Doing so could cause fire, an accident or injuries.**
- Do not get on a shipping box.
- Do not stack shipping boxes higher than the indicated information printed on those boxes.  
**Doing so could cause injuries.**

## Wiring

### **WARNING**

- When wiring the inverter to the power supply, insert a recommended molded case circuit breaker (MCCB) or residual-current-operated protective device (RCD)/a ground fault circuit interrupter (GFCI)(with overcurrent protection). Use the devices within the recommended current range.
- Use wires in the specified size.
- When wiring the inverter to the power supply that is 500 kVA or more, be sure to connect an optional DC reactor (DCR).  
**Otherwise, fire could occur.**
- Do not use one multicore cable in order to connect several inverters with motors.
- Do not connect a surge killer to the inverter's output (secondary) circuit.  
**Doing so could cause fire.**
- Ground the inverter in compliance with the national or local electric code.  
**Otherwise, electric shock could occur.**
- Qualified electricians should carry out wiring.
- Be sure to perform wiring after turning the power OFF.  
**Otherwise, electric shock could occur.**
- Be sure to perform wiring after installing the inverter body.  
**Otherwise, electric shock or injuries could occur.**

## **WARNING**

- Ensure that the number of input phases and the rated voltage of the product match the number of phases and the voltage of the AC power supply to which the product is to be connected.

**Otherwise fire or an accident could occur.**

- Do not connect the power supply wires to output terminals (U, V, and W).
- Do not insert a braking resistor between terminals P (+) and N (-), P1 and N (-), P (+) and P1, DB and N (-), or P1 and DB.

**Doing so could cause fire or an accident.**

- Generally, control signal wires are not reinforced insulation. If they accidentally touch any of live parts in the main circuit, their insulation coat may break for any reasons. In such a case, an extremely high voltage may be applied to the signal lines. Make a complete remedy to protect the signal line from contacting any hot high voltage lines.

**Doing so could cause an accident or electric shock.**

## **CAUTION**

- Wire the three-phase motor to terminals U, V, and W of the inverter, aligning phases each other.

**Otherwise injuries could occur.**

- The inverter, motor and wiring generate electric noise. Take care of malfunction of the nearby sensors and devices. To prevent the motor from malfunctioning, implement noise control measures.

**Otherwise an accident could occur.**

## **Operation**

## **WARNING**

- Be sure to install the terminal cover before turning the power ON. Do not remove the covers while power is applied.

**Otherwise electric shock could occur.**

- Do not operate switches with wet hands.



**Doing so could cause electric shock.**

- If the auto-reset function has been selected, the inverter may automatically restart and drive the motor depending on the cause of tripping.  
(Design the machinery or equipment so that human safety is ensured after restarting.)
- If the stall prevention function (current limiter), automatic deceleration, and overload prevention control have been selected, the inverter may operate at an acceleration/deceleration time or frequency different from the commanded ones. Design the machine so that safety is ensured even in such cases.

**Otherwise an accident could occur.**

## WARNING

- The  key on the keypad is effective only when the keypad operation is enabled with function code F02 (= 0, 2 or 3). When the keypad operation is disabled, prepare an emergency stop switch separately for safe operations.

Switching the run command source from keypad (local) to external equipment (remote) by turning ON the "Enable communications link" command **LE** disables the  key. To enable the  key for an emergency stop, select the STOP key priority with function code H96 (= 1 or 3).

- If an alarm reset is made with the Run command signal turned ON, a sudden start will occur. Ensure that the Run command signal is turned OFF in advance.

**Otherwise an accident could occur.**

- If you enable the "Restart mode after momentary power failure" (Function code F14 = 4 or 5), then the inverter automatically restarts running the motor when the power is recovered. (Design the machinery or equipment so that human safety is ensured after restarting.)
- If you set the function codes wrongly or without completely understanding this instruction manual and the FRENIC-Multi User's Manual, the motor may rotate with a torque or at a speed not permitted for the machine.

**An accident or injuries could occur.**

- Do not touch the inverter terminals while the power is applied to the inverter even if the inverter stops.

**Doing so could cause electric shock.**

## CAUTION

- Do not turn the main circuit power (circuit breaker) ON or OFF in order to start or stop inverter operation.

**Doing so could cause failure.**

- Do not touch the heat sink and braking resistor because they become very hot.

**Doing so could cause burns.**

- Setting the inverter to high speeds is easy. Before changing the frequency (speed) setting, check the specifications of the motor and machinery.
- The brake function of the inverter does not provide mechanical holding means.

**Injuries could occur.**

### Wiring length for EMC filter built-in type

## CAUTION

- When the wiring length between the inverter and motor exceeds 10 m, the filter circuit may be overheated and damaged due to increase of leakage current. To reduce the leakage current, set the motor sound (carrier frequency) to 2 kHz or below with function code F26.

**Otherwise a failure could occur.**

## Maintenance and inspection, parts replacement, and installation of an option card

### **WARNING**

- Turn the power OFF and wait for at least five minutes before starting inspection, parts replacement, and installation of an option card. Further, check that the LED monitor is unlit and that the DC link bus voltage between the P (+) and N (-) terminals is lower than 25 VDC.

**Otherwise, electric shock could occur.**

- Maintenance, inspection, and parts replacement should be made only by qualified persons.
- Take off the watch, rings and other metallic objects before starting work.
- Use insulated tools.

**Otherwise, electric shock or injuries could occur.**

## Disposal

### **CAUTION**

- Treat the inverter as an industrial waste when disposing of it.

**Otherwise injuries could occur.**

## Others

### **WARNING**

- Never attempt to modify the inverter.

**Doing so could cause electric shock or injuries.**

### **GENERAL PRECAUTIONS**

Drawings in this manual may be illustrated without covers or safety shields for explanation of detail parts. Restore the covers and shields in the original state and observe the description in the manual before starting operation.

## Conformity to the Low Voltage Directive in the EU

If installed according to the guidelines given below, inverters marked with CE or TÜV are considered as compliant with the Low Voltage Directive 73/23/EEC.

### CAUTION

1. The ground terminal G should always be connected to the ground. Do not use only a residual-current-operated protective device (RCD)/a ground fault circuit interrupter (GFCI)\* as the sole method of electric shock protection. Be sure to use ground wires whose size is greater than power supply lines.  
\*With overcurrent protection.
2. When used with the inverter, a molded case circuit breaker (MCCB), residual-current-operated protective device (RCD)/a ground fault circuit interrupter (GFCI) or magnetic contactor (MC) should conform to the EN or IEC standards.
3. When you use a residual-current-operated protective device (RCD)/a ground fault circuit interrupter (GFCI) for protection from electric shock in direct or indirect contact power lines or nodes, be sure to install **type B of RCD/GFCI** on the input (primary) of the inverter if the power supply is three-phase 230/460 V. For single-phase 230 V power supply, use **type A**.  
When you use no RCD/GFCI, take any other protective measure that isolates the electric equipment from other equipment on the same power supply line using double or reinforced insulation or that isolates the power supply lines connected to the electric equipment using an isolation transformer.
4. The inverter should be used in an environment that does not exceed Pollution Degree 2 requirements. If the environment conforms to Pollution Degree 3 or 4, install the inverter in an enclosure of IP54 or higher.
5. Install the inverter, AC or DC reactor, input or output filter in an enclosure with minimum degree of protection of IP2X (Top surface of enclosure shall be minimum IP4X when it can be easily accessed), to prevent human body from touching directly to live parts of these equipment.
6. To make an inverter with no integrated EMC filter conform to the EMC directive, it is necessary to connect an external EMC filter to the inverter and install them properly so that the entire equipment including the inverter conforms to the EMC directive.
7. Do not connect any copper wire directly to grounding terminals. Use crimp terminals with tin or equivalent plating to connect them.
8. To connect the three-phase or single-phase 230 V class series of inverters to the power supply in Overvoltage Category III or to connect the three-phase 460 V class series of inverters to the power supply in Overvoltage Category II or III, a supplementary insulation is required for the control circuitry.
9. When you use an inverter at an altitude of more than 6600ft (2000 m), you should apply basic insulation for the control circuits of the inverter. The inverter cannot be used at altitudes of more than 9800ft (3000 m).



## Conformity to the Low Voltage Directive in the EU (Continued)



### 10. Use wires listed in EN60204 Appendix C.

Power supply voltage	Applied motor rating (HP)	Inverter type	Rated current (A) <sup>*1</sup> of MCCB or RCD/GFCI		Recommended wire size (mm <sup>2</sup> )				Control circuit (30A, 30B, 30C)				
					Main circuit power input [L1/R, L2/S, L3/T] [L1/L, L2/N] Grounding		Inverter output [U, V, W]	DCR [P1, P(+)] Braking resistor [P(+), DB]					
			w/ DCR	w/o DCR <sup>*3</sup>	w/ DCR	w/o DCR <sup>*3</sup>							
Three-phase 230 V	1/8	FRNF12E1■-2U	5	5	2.5	2.5	2.5	2.5	0.5				
	1/4	FRNF25E1■-2U											
	1/2	FRNF50E1■-2U											
	1	FRN001E1■-2U	10	10									
	2	FRN002E1■-2U	15	15									
	3	FRN003E1■-2U	20	20									
	5	FRN005E1■-2U	20	30						4.0			
	7.5	FRN007E1■-2U	30	50						4.0	6.0	4.0	4.0
	10	FRN010E1■-2U	40	75						6.0	10	6.0	6.0
	15	FRN015E1■-2U	50	100						10	16	10	16
20	FRN020E1■-2U	75	125	16	25	16	25						
Three-phase 460 V	1/2	FRNF50E1■-4U	5	5	2.5	2.5	2.5	2.5	0.5				
	1	FRN001E1■-4U											
	2	FRN002E1■-4U											
	3	FRN003E1■-4U	10	15									
	5	FRN005E1■-4U	20	20									
	7.5	FRN007E1■-4U	15	30						4.0			
	10	FRN010E1■-4U	20	40						4.0	6.0	4.0	4.0
	15	FRN015E1■-4U	30	50						6.0	10	6.0	6.0
	20	FRN020E1■-4U	40	60						6.0	10	6.0	6.0
Single-phase 230 V	1/8	FRNF12E1■-7U	5	5	2.5	2.5	2.5	2.5	0.5				
	1/4	FRNF25E1■-7U											
	1/2	FRNF50E1■-7U											
	1	FRN001E1■-7U	10	15									
	2	FRN002E1■-7U	15	20						4.0			
	3	FRN003E1■-7U	20	30						4.0	6.0	4.0	

MCCB: Molded case circuit breaker  
GFCI: Ground fault circuit interrupter

RCD: Residual-current-operated protective device

Note 1) A box (■) in the above table replaces S (Standard type) or E (EMC filter built-in type) depending on the product specifications.

- \*1 The frame size and model of the MCCB or RCD/GFCI (with overcurrent protection) will vary, depending on the power transformer capacity. Refer to the related technical documentation for details.
- \*2 The recommended wire size for main circuits is for the 70°C(158°F) 600 V PVC wires used at an ambient temperature of 40°C(104°F).
- \*3 In the case of no DC reactor, the wire sizes are determined on the basis of the effective input current calculated under the condition that the power supply capacity and impedance are 500 kVA and 5%, respectively.

## Conformity to UL standards and Canadian standards (cUL certification)

If installed according to the guidelines given below, inverters marked with UL/cUL are considered as compliant with the UL and CSA (cUL certified) standards.

### CAUTION

1. Solid state motor overload protection (motor protection by electronic thermal overload relay) is provided in each model.  
Use function codes F10 to F12 to set the protection level.
2. Connect the power supply satisfying the characteristics shown in the table below as an input power supply of the inverter. (Short circuit rating)
3. Use 75°C(167°F) Cu wire only.
4. Use Class 1 wire only for control circuits.
5. Field wiring connection must be made by a UL Listed and CSA Certified closed-loop terminal connector sized for the wire gauge involved. Connector must be fixed using the crimp tool specified by the connector manufacturer.
6. Short circuit rating

Suitable for use on a circuit capable of delivering not more than 100 kA rms symmetrical amperes, 240 volts maximum for Three-phase or Single-phase 230 V input class.

Suitable for use on a circuit capable of delivering not more than 100 kA rms symmetrical amperes, 480 volts maximum for Three-phase 460 V input class.

**Conformity to UL standards and Canadian standards (cUL certification) (Continued)**



7. Install UL/CSA certified circuit breaker rated 240 V or more for 230 V input, 480 V or more for 460 V input between the power supply and the inverter, referring to the table below.

**Standard type**

Power supply voltage	Inverter type	Required torque lb-in (N·m)		Wire size AWG or kcmil (mm <sup>2</sup> )		Circuit breaker (A)	
		Main terminal	Control circuit	Main terminal	Control circuit		
Three-phase 230 V	FRNF12E1S-2U	10.6 (1.2)	4.4 (0.5)	14	20 (0.5)	5	
	FRNF25E1S-2U					5	
	FRNF50E1S-2U					5	
	FRN001E1S-2U					10	
	FRN002E1S-2U	15.9 (1.8)				15	
	FRN003E1S-2U					20	
	FRN005E1S-2U					30	
	FRN007E1S-2U	33.6 (3.8)				8	50
	FRN010E1S-2U					6	75
	FRN015E1S-2U	51.3 (5.8)				6	100
FRN020E1S-2U	4		125				
Three-phase 460 V	FRNF50E1S-4U	15.9 (1.8)	3.5 (0.4)	14	20 (0.5)	5	
	FRN001E1S-4U					5	
	FRN002E1S-4U					10	
	FRN003E1S-4U					15	
	FRN005E1S-4U	33.6 (3.8)				20	
	FRN007E1S-4U					30	
	FRN010E1S-4U					40	
	FRN015E1S-4U	51.3 (5.8)				10	50
FRN020E1S-4U	8		60				
Single-phase 230 V	FRNF12E1S-7U	10.6 (1.2)	4.4 (0.5)	14	20 (0.5)	5	
	FRNF25E1S-7U					5	
	FRNF50E1S-7U					10	
	FRN001E1S-7U					15	
	FRN002E1S-7U	15.9 (1.8)				12	20
	FRN003E1S-7U					10	30





**EMC filter built-in type**

Power supply voltage	Inverter type	Required torque lb-in (N·m)		Wire size AWG or kcmil (mm <sup>2</sup> )		Circuit breaker (A)
		Main terminal	Control circuit	Main terminal	Control circuit	
Three-phase 230 V	FRNF12E1E-2U	10.6 (1.2)	4.4 (0.5)	14	20 (0.5)	5
	FRNF25E1E-2U					5
	FRNF50E1E-2U					5
	FRN001E1E-2U					10
	FRN002E1E-2U	15.9 (1.8)		15		
	FRN003E1E-2U			20		
	FRN005E1E-2U			30		
	FRN007E1E-2U	Output: 33.6 (3.8) Input: 16.2 (1.8)		50		
	FRN010E1E-2U	75				
	FRN015E1E-2U	Output: 51.3 (5.8) Input: 72.0 (8.1)		100		
FRN020E1E-2U	125					
Three-phase 460 V	FRNF50E1E-4U	15.9 (1.8)	4.4 (0.5)	14	20 (0.5)	5
	FRN001E1E-4U					5
	FRN002E1E-4U					10
	FRN003E1E-4U					15
	FRN005E1E-4U	20				
	FRN007E1E-4U	Output: 33.6 (3.8) Input: 16.2 (1.8)		30		
	FRN010E1E-4U	40				
	FRN015E1E-4U	Output: 51.3 (5.8) Input: 16.2 (1.8)		50		
FRN020E1E-4U	60					
Single-phase 230 V	FRNF12E1E-7U	10.6 (1.2)	4.4 (0.5)	14	20 (0.5)	5
	FRNF25E1E-7U					5
	FRNF50E1E-7U					10
	FRN001E1E-7U	15				
	FRN002E1E-7U	15.9 (1.8)		20		
	FRN003E1E-7U	30				

## ■ Precautions for use

In running general-purpose motors	Driving a 460 V general-purpose motor	When driving a 460V general-purpose motor with an inverter using extremely long wires, damage to the insulation of the motor may occur. Use an output circuit filter (OFL) if necessary after checking with the motor manufacturer. Fuji motors do not require the use of output circuit filters because of their reinforced insulation.
	Torque characteristics and temperature rise	When the inverter is used to run a general-purpose motor, the temperature of the motor becomes higher than when it is operated using a commercial power supply. In the low-speed range, the cooling effect will be weakened, so decrease the output torque of the motor.
	Vibration	When an inverter-driven motor is mounted to a machine, resonance may be caused by the natural frequencies of the machine system. Note that operation of a 2-pole motor at 60 Hz or higher may cause abnormal vibration. * The use of a rubber coupling or vibration-proof rubber is recommended. * Use the inverter's jump frequency control feature to skip the resonance frequency zone(s).
	Noise	When an inverter is used with a general-purpose motor, the motor noise level is higher than that with a commercial power supply. To reduce noise, raise carrier frequency of the inverter. Operation at 60 Hz or higher can also result in higher noise level.
In running special motors	High-speed motors	If the reference frequency is set to 120 Hz or more to drive a high-speed motor, test-run the combination of the inverter and motor beforehand to check for safe operation.
	Explosion-proof motors	When driving an explosion-proof motor with an inverter, use a combination of a motor and an inverter that has been approved in advance.
	Submersible motors and pumps	These motors have a larger rated current than general-purpose motors. Select an inverter whose rated output current is greater than that of the motor. These motors differ from general-purpose motors in thermal characteristics. Set a low value in the thermal time constant of the motor when setting the electronic thermal function.
	Brake motors	For motors equipped with parallel-connected brakes, their power supply for brake must be supplied from the primary circuit. If the power supply for brake is connected to the inverter's output circuit by mistake, the brake will not work. Do not use inverters for driving motors equipped with series-connected brakes.
	Geared motors	If the power transmission mechanism uses an oil-lubricated gearbox or speed changer/reducer, then continuous operation at low speed may cause poor lubrication. Avoid such operation.

In running special motors	Synchronous motors	It is necessary to take special measures suitable for this motor type. Consult your Fuji Electric representative for details.
	Single-phase motors	Single-phase motors are not suitable for inverter-driven variable speed operation. Use three-phase motors.  Even if a single-phase power supply is available, use a three-phase motor as the inverter provides three-phase output.
Environmental conditions	Installation location	Use the inverter within the ambient temperature range from $-10^{\circ}\text{C}(14^{\circ}\text{F})$ to $+50^{\circ}\text{C}(122^{\circ}\text{F})$ .  The heat sink and braking resistor of the inverter may become hot under certain operating conditions, so install the inverter on nonflammable material such as metal.  Ensure that the installation location meets the environmental conditions specified in Chapter 2, Section 2.1 "Operating Environment."
Combination with peripheral devices	Installing an MCCB or RCD/GFCI	Install a recommended molded case circuit breaker (MCCB) or residual-current-operated protective device (RCD)/a ground fault circuit interrupter (GFCI) (with overcurrent protection) in the primary circuit of the inverter to protect the wiring. Ensure that the circuit breaker rated current is equivalent to or lower than the recommended rated current.
	Installing an MC in the secondary circuit	If a magnetic contactor (MC) is mounted in the inverter's output (secondary) circuit for switching the motor to commercial power or for any other purpose, ensure that both the inverter and the motor are completely stopped before you turn the MC ON or OFF.  Remove the magnet contactor (MC) already installed and built-in surge killer from the inverter's output (secondary) circuit before installing the MC to switch the motor power.
	Installing an MC in the primary circuit	Do not turn the magnetic contactor (MC) in the primary circuit ON or OFF more than once an hour as an inverter failure may result.  If frequent starts or stops are required during motor operation, use terminal [FWD]/[REV] signals or the  /  key.
	Protecting the motor	The electronic thermal function of the inverter can protect the motor. The operation level and the motor type (general-purpose motor, inverter motor) should be set. For high-speed motors or water-cooled motors, set a small value for the thermal time constant and protect the motor.  If you connect the motor thermal relay to the motor with a long wire, a high-frequency current may flow into the wiring stray capacitance. This may cause the relay to trip at a current lower than the set value for the thermal relay. If this happens, lower the carrier frequency or use the output circuit filter (OFL).

Combination with peripheral devices	Discontinuance of power capacitor for power factor correction	Do not mount power capacitors for power factor correction in the inverter's primary circuit. (Use the DC reactor to correct the inverter power factor.) Do not use power capacitors for power factor correction in the inverter's output (secondary) circuit. An overcurrent trip will occur, disabling motor operation.
	Discontinuance of surge killer	Do not connect a surge killer to the inverter's output (secondary) circuit.
	Reducing noise	Use of a filter and shielded wires is typically recommended to satisfy EMC Directive.
	Measures against surge currents	If an overvoltage trip occurs while the inverter is stopped or operated under a light load, it is assumed that the surge current is generated by open/close of the power capacitor for power factor correction in the power system. * Connect a DC reactor to the inverter.
	Megger test	When checking the insulation resistance of the inverter, use a 500 V megger and follow the instructions contained in Chapter 7, Section 7.5 "Insulation Test."
Wiring	Control circuit wiring length	When using remote control, limit the wiring length between the inverter and operator panel to 66ft (20 m) or less and use twisted pair or shielded wire.
	Wiring length between inverter and motor	If long wiring is used between the inverter and the motor, the inverter will overheat or trip as a result of overcurrent (high-frequency current flowing into the stray capacitance) in the wires connected to the phases. Ensure that the wiring is shorter than 164ft (50 m). If this length must be exceeded, lower the carrier frequency or mount an output circuit filter (OFL).
	Wiring size	Select wires with a sufficient capacity by referring to the current value or recommended wire size.
	Wiring type	When several inverters drive motors, do not use one multicore cable in order to connect several inverters with motors.
	Grounding	Securely ground the inverter using the grounding terminal.
Selecting inverter capacity	Driving general-purpose motor	Select an inverter according to the nominal applied motor rating listed in the standard specifications table for the inverter. When high starting torque is required or quick acceleration or deceleration is required, select an inverter with one rank larger capacity than the standard.
	Driving special motors	Select an inverter that meets the following condition: Inverter rated current > Motor rated current

Transportation and storage	<p>When exporting an inverter built in a panel or equipment, pack them in a previously fumigated wooden crate. Do not fumigate them after packing since some parts inside the inverter may be corroded by halogen compounds such as methyl bromide used in fumigation.</p> <p>When packing an inverter alone for export, use a laminated veneer lumber (LVL).</p> <p>For other transportation and storage instructions, see Chapter 1, Section 1.3 "Transportation" and Section 1.4 "Storage Environment."</p>
----------------------------	--



## How this manual is organized

This manual is made up of chapters 1 through 10.

### Chapter 1 BEFORE USING THE INVERTER

This chapter describes acceptance inspection and precautions for transportation and storage of the inverter.

### Chapter 2 MOUNTING AND WIRING OF THE INVERTER

This chapter provides operating environment, precautions for installing the inverter, wiring instructions for the motor and inverter.

### Chapter 3 OPERATION USING THE KEYPAD

This chapter describes inverter operation using the keypad. The inverter features three operation modes (Running, Programming and Alarm modes) which enable you to run and stop the motor, monitor running status, set function code data, display running information required for maintenance, and display alarm data.

### Chapter 4 RUNNING THE MOTOR

This chapter describes preparation to be made before running the motor for a test and practical operation.

### Chapter 5 FUNCTION CODES

This chapter provides a list of the function codes. Function codes to be used often and irregular ones are described individually.

### Chapter 6 TROUBLESHOOTING

This chapter describes troubleshooting procedures to be followed when the inverter malfunctions or detects an alarm condition. In this chapter, first check whether any alarm code is displayed or not, and then proceed to the troubleshooting items.

### Chapter 7 MAINTENANCE AND INSPECTION

This chapter describes inspection, measurement and insulation test which are required for safe inverter operation. It also provides information about periodical replacement parts and guarantee of the product.

### Chapter 8 SPECIFICATIONS

This chapter lists specifications including output ratings, control system, external dimensions and protective functions.

### Chapter 9 LIST OF PERIPHERAL EQUIPMENT AND OPTIONS

This chapter describes main peripheral equipment and options which can be connected to the FRENIC-Multi series of inverters.

### Chapter 10 COMPLIANCE WITH STANDARDS

This chapter describes standards with which the FRENIC-Multi series of inverters comply.

## Icons

The following icons are used throughout this manual.

 **Note** This icon indicates information which, if not heeded, can result in the inverter not operating to full efficiency, as well as information concerning incorrect operations and settings which can result in accidents.

 **Tip** This icon indicates information that can prove handy when performing certain settings or operations.



This icon indicates a reference to more detailed information.

# Table of Content

Preface .....	i	Chapter 4 RUNNING THE MOTOR .....	4-1
■ Safety precautions.....	i	4.1 Running the Motor for a Test.....	4-1
■ Precautions for use .....	xi	4.1.1 Inspection and preparation prior to powering on.....	4-1
How this manual is organized .....	xv	4.1.2 Turning ON power and checking.....	4-1
Chapter 1 BEFORE USING THE INVERTER .....	1-1	4.1.3 Preparation before running the motor for a test--Setting function code data.....	4-2
1.1 Acceptance Inspection .....	1-1	4.1.4 Test run .....	4-4
1.2 External View and Terminal Blocks .....	1-2	4.2 Operation.....	4-5
1.3 Transportation .....	1-3	4.2.1 Jogging Operation .....	4-5
1.4 Storage Environment.....	1-3	Chapter 5 FUNCTION CODES .....	5-1
1.4.1 Temporary storage .....	1-3	5.1 Function Code Tables.....	5-1
1.4.2 Long-term storage.....	1-3	5.2 Overview of Function Codes .....	5-18
Chapter 2 MOUNTING AND WIRING OF THE INVERTER .....	2-1	Chapter 6 TROUBLESHOOTING .....	6-1
2.1 Operating Environment .....	2-1	6.1 Before Proceeding with Troubleshooting... 6-1	
2.2 Installing the Inverter .....	2-1	6.2 If No Alarm Code Appears on the LED Monitor .....	6-2
2.3 Wiring.....	2-4	6.2.1 Motor is running abnormally .....	6-2
2.3.1 Removing and mounting the terminal cover and the main circuit terminal block cover.....	2-4	6.2.2 Problems with inverter settings .....	6-8
2.3.2 Terminal arrangement diagram and screw specifications .....	2-7	6.3 If an Alarm Code Appears on the LED Monitor .....	6-10
2.3.3 Recommended wire sizes .....	2-10	6.4 If an Abnormal Pattern Appears on the LED Monitor while No Alarm Code is Displayed.....	6-24
2.3.4 Wiring precautions .....	2-11	Chapter 7 MAINTENANCE AND INSPECTION .. 7-1	
2.3.5 Wiring for main circuit terminals and grounding terminals.....	2-11	7.1 Daily Inspection .....	7-1
2.3.6 Wiring for control circuit terminals .. 2-16		7.2 Periodic Inspection .....	7-1
2.3.7 Setting up the slide switches.....	2-23	7.3 List of Periodical Replacement Parts..... 7-3	
2.4 Mounting and Connecting a Keypad .. 2-25		7.3.1 Judgment on service life.....	7-4
2.4.1 Mounting style and parts needed for connection.....	2-25	7.4 Measurement of Electrical Amounts in Main Circuit .....	7-6
2.4.2 Mounting/installing steps .....	2-26	7.5 Insulation Test .....	7-8
2.5 Cautions Relating to Harmonic Component, Noise, and Leakage Current .....	2-28	7.6 Inquiries about Product and Guarantee .. 7-9	
Chapter 3 OPERATION USING THE KEYPAD... 3-1		7.6.1 When making an inquiry.....	7-9
3.1 LED Monitor, Keys and LED Indicators on the Keypad .....	3-1	7.6.2 Product warranty .....	7-9
3.2 Overview of Operation Modes.....	3-2	Chapter 8 SPECIFICATIONS.....	8-1
3.3 Running Mode .....	3-4	8.1 Standard Models .....	8-1
3.3.1 Monitoring the running status .....	3-4	8.1.1 Three-phase 230 V class series .....	8-1
3.3.2 Setting up frequency and PID commands.....	3-6	8.1.2 Three-phase 460 V class series .....	8-2
3.3.3 Running/stopping the motor .....	3-11	8.1.3 Single-phase 230 V class series .....	8-3
3.4 Programming Mode.....	3-11	8.2 Models Available on Order (EMC filter built-in type).....	8-4
3.4.1 Setting up basic function codes quickly – Menu #0 "Quick Setup" – .....	3-13	8.2.1 Three-phase 230 V class series .....	8-4
3.4.2 Setting up function codes – Menu #1 "Data Setting" – .....	3-15	8.2.2 Three-phase 460 V class series .....	8-4
3.4.3 Checking changed function codes – Menu #2 "Data Checking" – .....	3-16	8.2.3 Single-phase 230 V class series .....	8-4
3.4.4 Monitoring the running status – Menu #3 "Drive Monitoring" – .....	3-16	8.3 Specifications of Keypad Related .....	8-5
3.4.5 Checking I/O signal status – Menu #4 "I/O Checking" – .....	3-19	8.3.1 General specifications of keypad.....	8-5
3.4.6 Reading maintenance information – Menu #5 "Maintenance Information" – ..	3-23	8.3.2 Communications specifications of keypad.....	8-5
3.4.7 Reading alarm information – Menu #6 "Alarm Information" – .....	3-25	8.4 Terminal Specifications .....	8-6
3.5 Alarm Mode.....	3-27	8.4.1 Terminal functions .....	8-6
		8.4.2 Running the inverter with keypad .....	8-6
		8.4.3 Running the inverter by terminal commands.....	8-7
		8.5 External Dimensions .....	8-8
		8.5.1 Standard models .....	8-8
		8.5.2 Models Available on Order (EMC filter built-in type).....	8-11
		8.5.3 Standard keypad .....	8-14
		8.6 Protective Functions .....	8-15

Chapter 9 LIST OF PERIPHERAL EQUIPMENT AND OPTIONS.....	9-1
Chapter 10 COMPLIANCE WITH STANDARDS.	10-1
10.1 Compliance with UL Standards and Canadian Standards (cUL certification) ...	10-1
10.1.1 General.....	10-1
10.1.2 Considerations when using FRENIC-Multi in systems to be certified by UL and cUL.....	10-1
10.2 Compliance with European Standards ....	10-1
10.3 Compliance with EMC Standards .....	10-2
10.3.1 General .....	10-2
10.3.2 Recommended installation procedure .....	10-2
10.3.3 Leakage current from EMC-filter built-in type inverters or inverters with an external EMC-complaint filter (optional) .....	10-5
10.4 Harmonic Component Regulation in the EU .....	10-7
10.4.1 General comments .....	10-7
10.4.2 Compliance with the harmonic component regulation.....	10-8
10.5 Compliance with the Low Voltage Directive in the EU.....	10-8
10.5.1 General .....	10-8
10.5.2 Points for consideration when using the FRENIC-Multi series in a system to be certified by the Low Voltage Directive in the EU.....	10-8

# Chapter 1 BEFORE USING THE INVERTER

## 1.1 Acceptance Inspection

Unpack the package and check the following:

- (1) An inverter and accessories below are contained in the package.
  - Cooling fan fixing screws (for inverters of 7.5 to 20 HP)
  - Keypad rear cover (with fixing screws)
  - Instruction manual (this manual)
- (2) The inverter has not been damaged during transportation—there should be no dents or parts missing.
- (3) The inverter is the model you ordered. You can check the model name and specifications on the main nameplate. (Main and sub nameplates are attached to the inverter and are located as shown on the following page.)

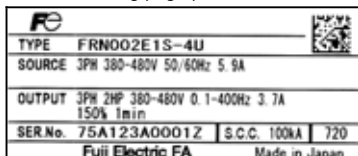

(a) Main Nameplate



(b) Sub Nameplate

Figure 1.1 Nameplates

TYPE: Type of inverter

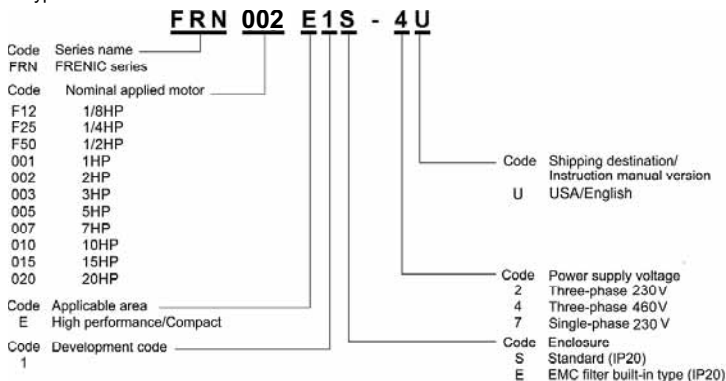

**SOURCE:** Number of input phases (three-phase: 3PH, single-phase: 1PH), input voltage, input frequency, input current

**OUTPUT:** Number of output phases, rated output capacity, rated output voltage, output frequency range, rated output current, overload capacity

**SER. No.:** Product number

**75A123A0001Z**

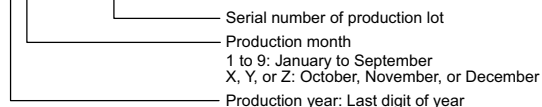

If you suspect the product is not working properly or if you have any questions about your product, contact your Fuji Electric representative.

## 1.2 External View and Terminal Blocks

### (1) Outside and inside views

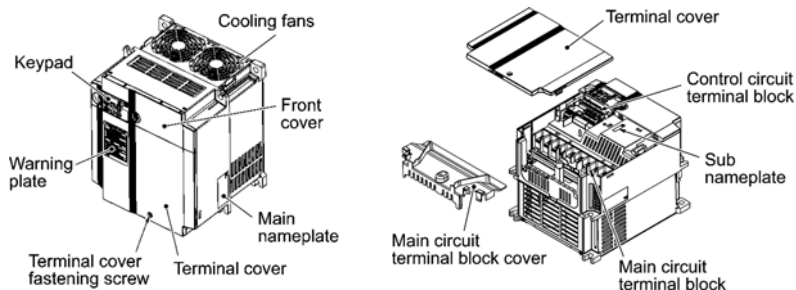

Figure 1.2 Outside and Inside Views of Inverters (FRN020E1S-2U)

### (2) Warning plates and label



Figure 1.3 Warning Plate and Sub Nameplate

### (3) Terminal block location

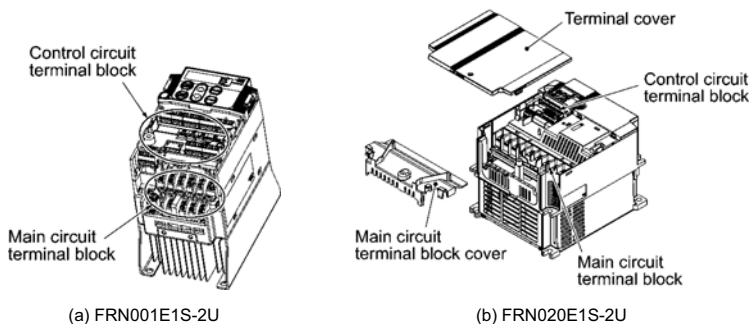

Figure 1.4 Terminal Blocks

### 1.3 Transportation

- When carrying an inverter, always support its bottom at the right and left sides with both hands. Do not hold covers or individual parts only.
- Avoid applying excessively strong force to the terminal block covers as they are made of plastic and are easily broken.

### 1.4 Storage Environment

#### 1.4.1 Temporary storage

Store the inverter in an environment that satisfies the requirements listed in Table 1.1.

Table 1.1 Environmental Requirements for Storage and Transportation

Item	Requirements	
Storage temperature *1	-25(-13°F) to +70°C(158°F)	A location where the inverter is not subject to abrupt changes in temperature that would result in the formation of condensation or ice.
Relative humidity	5 to 95% *2	
Atmosphere	The inverter must not be exposed to dust, direct sunlight, corrosive or flammable gases, oil mist, vapor, water drops or vibration. The atmosphere must contain only a low level of salt. (0.01 mg/cm <sup>2</sup> or less per year)	
Atmospheric pressure	86 to 106 kPa (in storage)	
	70 to 106 kPa (during transportation)	

\*1 Assuming a comparatively short storage period (e.g., during transportation or the like).

\*2 Even if the humidity is within the specified requirements, avoid such places where the inverter will be subjected to sudden changes in temperature that will cause condensation to form.

#### Precautions for temporary storage

- (1) Do not leave the inverter directly on the floor.
- (2) If the environment does not satisfy the specified requirements, wrap the inverter in an airtight vinyl sheet or the like for storage.
- (3) If the inverter is to be stored in an environment with a high level of humidity, put a drying agent (such as silica gel) in the airtight package described in item (2).

#### 1.4.2 Long-term storage

The long-term storage methods for the inverter vary largely according to the environment of the storage site. General storage methods are described below.

- (1) The storage site must satisfy the requirements specified for temporary storage. However, for storage exceeding three months, the ambient temperature should be within the range from -10°C(14°F) to +30°C(86°F). This is to prevent the electrolytic capacitors in the inverter from deteriorating.
- (2) The inverter must be stored in a package that is airtight to protect it from moisture. Include a drying agent inside the package to maintain the relative humidity inside the package within 70%.
- (3) If the inverter has been installed in the equipment or control panel at a construction site where it may be subjected to humidity, dust or dirt, then remove the inverter and store it in a suitable environment specified in Table 1.1.

#### Precautions for storage over 1 year

If the inverter will not be powered on for a long time, the property of the electrolytic capacitors may deteriorate. Power the inverters on once a year and keep them on for 30 to 60 minutes. Do not connect the inverter to a motor or run the motor.

## Chapter 2 MOUNTING AND WIRING OF THE INVERTER

### 2.1 Operating Environment

Install the inverter in an environment that satisfies the requirements listed in Table 2.1.

Table 2.1 Environmental Requirements

Item	Specifications
Site location	Indoors
Ambient temperature	-10°C(14°F) to +50°C(122°F) (Note 1)
Relative humidity	5 to 95% (No condensation)
Atmosphere	The inverter must not be exposed to dust, direct sunlight, corrosive gases, flammable gas, oil mist, vapor or water drops. (Note 2) The atmosphere can contain only a low level of salt. (0.01 mg/cm <sup>2</sup> or less per year) The inverter must not be subjected to sudden changes in temperature that will cause condensation to form.
Altitude	3300ft (1000 m) max. (Note 3)
Atmospheric pressure	86 to 106 kPa
Vibration	0.12inch(3 mm) (Max. amplitude) 2 to less than 9 Hz 9.8 m/s <sup>2</sup> 9 to less than 20 Hz 2 m/s <sup>2</sup> 20 to less than 55 Hz 1 m/s <sup>2</sup> 55 to less than 200 Hz

Table 2.2 Output Current Derating Factor in Relation to Altitude

Altitude	Output current derating factor
3300ft (1000m) or lower	1.00
3300ft (1000) to 4900ft (1500m)	0.97
4900ft (1500) to 6600ft (2000m)	0.95
6600ft (2000) to 8200ft (2500m)	0.91
8200ft (2500) to 9800ft (3000m)	0.88

(Note 1) When inverters are mounted side-by-side without any gap between them (less than 7.5HP), the ambient temperature should be within the range from -10°C(14°F) to +40°C(104°F).

(Note 2) Do not install the inverter in an environment where it may be exposed to cotton waste or moist dust or dirt which will clog the heat sink in the inverter. If the inverter is to be used in such an environment, install it in the panel of your system or other dustproof containers.

(Note 3) If you use the inverter in an altitude above 3300ft(1000 m), you should apply an output current derating factor as listed in Table 2.2.

### 2.2 Installing the Inverter

#### (1) Mounting base

The temperature of the heat sink will rise up to approx. 90°C(194°F) during operation of the inverter, so the inverter should be mounted on a base made of material that can withstand temperatures of this level.

#### **⚠ WARNING**

Install the inverter on a base constructed from metal or other non-flammable material.

**A fire may result with other material.**

#### (2) Clearances

Ensure that the minimum clearances indicated in Figure 2.1 are maintained at all times. When installing the inverter in the panel of your system, take extra care with ventilation inside the panel as the temperature around the inverter will tend to increase. Do not install the inverter in a small panel with poor ventilation.



Figure 2.1 Mounting Direction and Required Clearances

### ■ When mounting two or more inverters

Horizontal layout is recommended when two or more inverters are to be installed in the same unit or panel. If it is necessary to mount the inverters vertically, install a partition plate or the like between the inverters so that any heat radiating from an inverter will not affect the one/s above. As long as the ambient temperature is 40°C (104°F) or lower, inverters can be mounted side-by-side without any gap between them (only for inverters with a capacity of less than 7.5 HP).

### ■ When employing external cooling

At the shipment time, the inverter is set up for mount inside your equipment or panel so that cooling is done all internally.

To improve cooling efficiently, you can take the heat sink out of the equipment or the panel (as shown on the right) so that cooling is done both internally and externally (this is called "external cooling").

In external cooling, the heat sink, which dissipates about 70% of the total heat (total loss) generated into air, is situated outside the equipment or the panel. As a result, much less heat is radiated inside the equipment or the panel.

To take advantage of external cooling, you need to use the external cooling attachment option for inverters with a capacity of 7.5 HP or above.

In an environment with high humidity or a lot of fibrous dust, however, do not use external cooling in an environment with high humidity or a lot of fibrous dust, which tends to clog the heat sink.

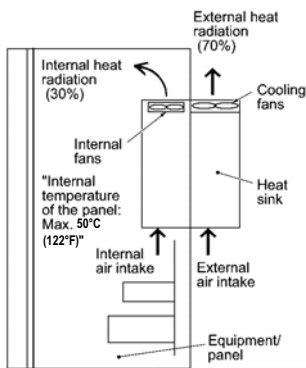

For details, refer to the Mounting Adapter for External Cooling "PB-F1/E1" Installation Manual.

Figure 2.2 External Cooling

## ⚠ CAUTION

Prevent lint, paper fibers, sawdust, dust, metallic chips, or other foreign materials from getting into the inverter or from accumulating on the heat sink.

**This may result in a fire or accident.**



### (3) Mounting direction

Mount the inverter vertically to the mounting surface and fix it securely with four screws or bolts so that the logo "FRENIC-Multi" can be seen from the front.

**Note** Do not mount the inverter upside down or horizontally. Doing so will reduce the heat dissipation efficiency of the inverter and cause the overheat protection function to operate, so the inverter will not run.

### (4) Solving abnormal vibration after installation

If any vibration in the surroundings reaches the inverter and causes abnormal vibration to the cooling fans or the keypad, fix them firmly using the fixing screws provided as accessories.

#### ■ Fixing the cooling fans

Table 2.3 Fixing Screws

Power supply voltage	Nominal applied motor (HP)	Inverter type	Screw size (accessory)	Tightening torque (N·m)
Three-phase 230 V	7.5	FRN007E1 ■-2U	M4x35 (4 pcs)	0.8
	10	FRN010E1 ■-2U		
	15	FRN015E1 ■-2U		
	20	FRN020E1 ■-2U		
Three-phase 460 V	7.5	FRN007E1 ■-4U		
	10	FRN010E1 ■-4U		
	15	FRN015E1 ■-4U		
	20	FRN020E1 ■-4U		

**Note 1)** A box (■) in the above table replaces S or E depending on the enclosure.

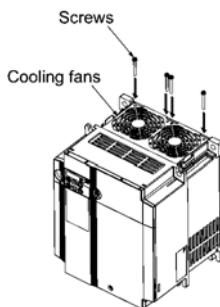

Figure 2.3 Fixing the Cooling Fans

## 2.3 Wiring

Follow the procedure below. (In the following description, the inverter has already been installed.)

### 2.3.1 Removing and mounting the terminal cover and the main circuit terminal block cover

#### (1) For inverters with a capacity of 5HP or below

- ① To remove the terminal cover, put your finger in the dimple of the terminal cover (labeled "PULL"), and then pull it up toward you.
- ② To remove the main circuit terminal block cover, hold its right and left ends with your fingers and slide it toward you.

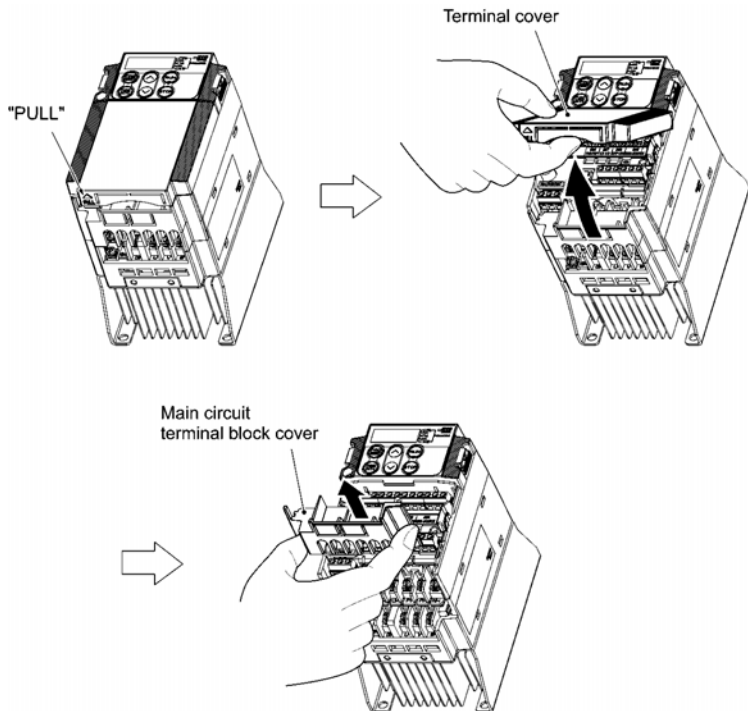

Figure 2.4 Removing the Covers (For Inverters with a Capacity of 5HP or below)

**(2) For inverters with a capacity of 7.5 and 10 HP**

- ① To remove the terminal cover, first loosen the terminal cover fixing screw on it, and put your finger in the dimple of the terminal cover (labeled "PULL"), and then pull it up toward you.
- ② To remove the main circuit terminal block cover, put your thumbs on the handles of the main circuit terminal block cover, and push it up while supporting it with your fingers. (Refer to Figure 2.5.)

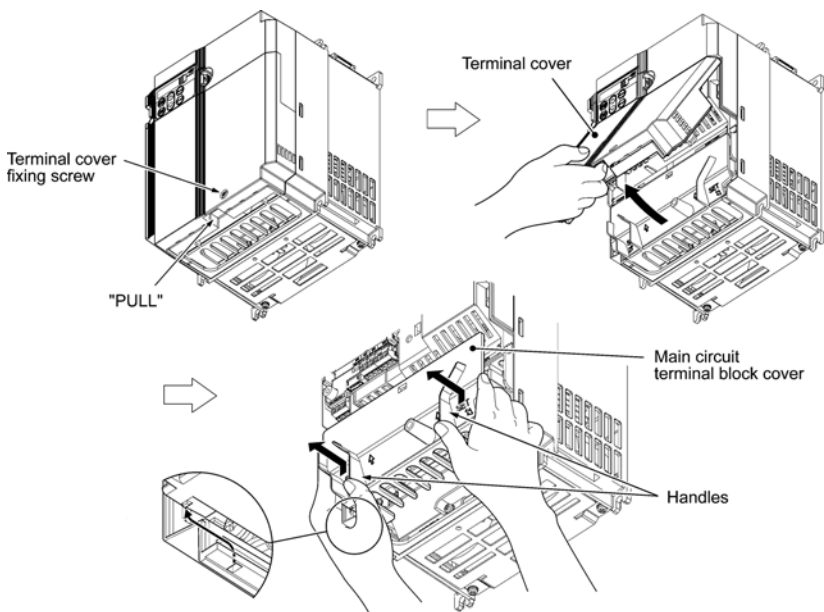

Figure 2.5 Removing the Covers (For Inverters with a Capacity of 7.5 and 10 HP)

**Note** When mounting the main circuit terminal block cover, fit it according to the guide on the inverter.

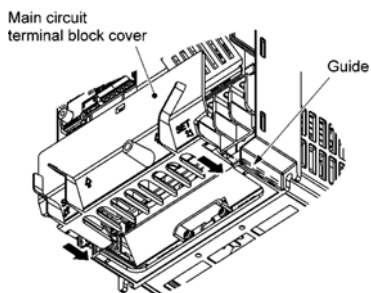

Figure 2.6 Mounting the main circuit terminal block cover  
(For Inverters with a Capacity of 7.5 and 10HP)

### (3) For inverters with a capacity of 15 and 20 HP

- ① To remove the terminal cover, first loosen the terminal cover fixing screw on it, and put your finger in the dimple of the terminal cover (labeled "PULL"), and then pull it up toward you.
- ② To remove the main circuit terminal block cover, hold the handles on the both sides of the main circuit terminal block cover, and pull it up.

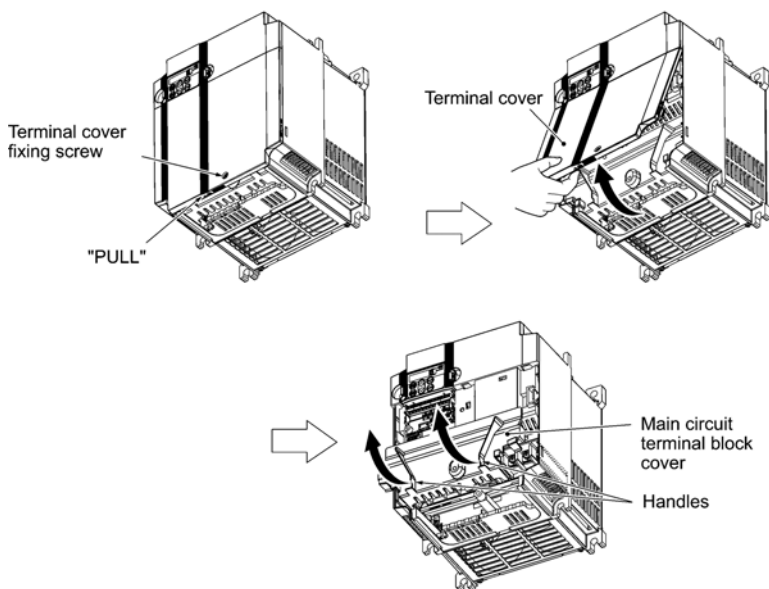

Figure 2.7 Removing the Covers (For Inverters with a Capacity of 15 and 20 HP)

**Note** When mounting the main circuit terminal block cover, fit it according to the guide on the inverter.

- ① Insert the main circuit terminal block cover by fitting the part labeled "GUIDE" according to the guide on the inverter.
- ② Push where "PUSH" are labeled to snap it into the inverter.

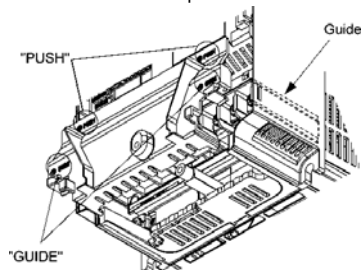



Figure 2.8 Mounting the Main Circuit Terminal Block Cover  
(For Inverters with a Capacity of 15 and 20 HP)

### 2.3.2 Terminal arrangement diagram and screw specifications

The table below shows the main circuit screw sizes, tightening torque and terminal arrangements. Note that the terminal arrangements differ according to the inverter types. Two terminals designed for grounding shown as the symbol,  in Figures A to E make no distinction between a power supply source (a primary circuit) and a motor (a secondary circuit).

#### (1) Arrangement of the main circuit terminals

Table 2.4 Main Circuit Terminal Properties

Power supply voltage	Nominal applied motor (HP)	Inverter type	Terminal screw size	Tightening torque (lb-in (N·m))	Grounding screw size	Tightening torque (lb-in (N·m))	Refer to:	
Three-phase 230 V	1/8	FRNF12E1■-2U	M3.5	10.6 (1.2)	M3.5	10.6 (1.2)	Figure A	
	1/4	FRNF25E1■-2U						
	1/2	FRNF50E1■-2U						
		1	FRN001E1■-2U	M4	15.9 (1.8)	M4	15.9 (1.8)	Figure B
		2	FRN002E1■-2U					
		3	FRN003E1■-2U					
		5	FRN005E1■-2U					
		7.5	FRN007E1S-2U					
			FRN007E1E-2U	Input: M4 Output: M5	15.9(1.8)	Figure F		
		10	FRN010E1S-2U	M5	33.6(3.8)	M5	33.6 (3.8)	Figure C
			FRN010E1E-2U	Input: M4 Output: M5	15.9(1.8)			Figure F
		15	FRN015E1S-2U	M6	51.3(5.8)	M6	51.3 (5.8)	Figure C
FRN015E1E-2U			71.7(8.1)		Figure F			
20	FRN020E1S-2U	51.3(5.8)	M6		51.3 (5.8)	Figure C		
	FRN020E1E-2U	71.7(8.1)				Figure F		
Three-phase 460 V	1/2	FRNF50E1■-4U	M4	15.9 (1.8)	M4	15.9 (1.8)	Figure B	
	1	FRN001E1■-4U						
	2	FRN002E1■-4U						
	3	FRN003E1■-4U						
	5	FRN005E1■-4U						
	7.5	FRN007E1S-4U	M5	33.6(3.8)	M5	33.6 (3.8)	Figure C	
		FRN007E1E-4U	Input: M4 Output: M5	15.9(1.8)			Figure F	
	10	FRN010E1S-4U	M5	33.6(3.8)	M5	33.6 (3.8)	Figure C	
		FRN010E1E-4U	Input: M4 Output: M5	15.9(1.8)			Figure F	
	15	FRN015E1S-4U	M6	51.3(5.8)	M6	51.3 (5.8)	Figure C	
		FRN015E1E-4U	Input: M4 Output: M6	15.9(1.8)			Figure F	
	20	FRN020E1S-4U	M6	51.3(5.8)	M6	51.3 (5.8)	Figure C	
		FRN020E1E-4U	Input: M4 Output: M6	15.9(1.8)			Figure F	
	Single-phase 230 V	1/8	FRNF12E1■-7U	M3.5	10.6 (1.2)	M3.5	10.6 (1.2)	Figure D
1/4		FRNF25E1■-7U						
1/2		FRNF50E1■-7U						
1		FRN001E1■-7U	M4	15.9 (1.8)	M4	15.9 (1.8)	Figure E	
2		FRN002E1■-7U						
3		FRN003E1■-7U						

**Note 1)** A box (■) in the above table replaces S or E depending on the enclosure.

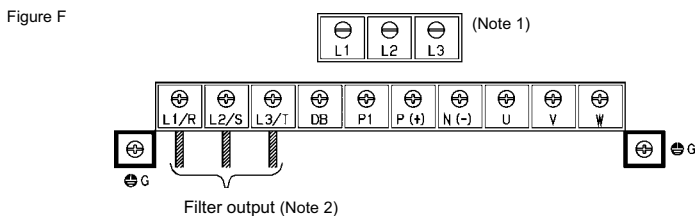
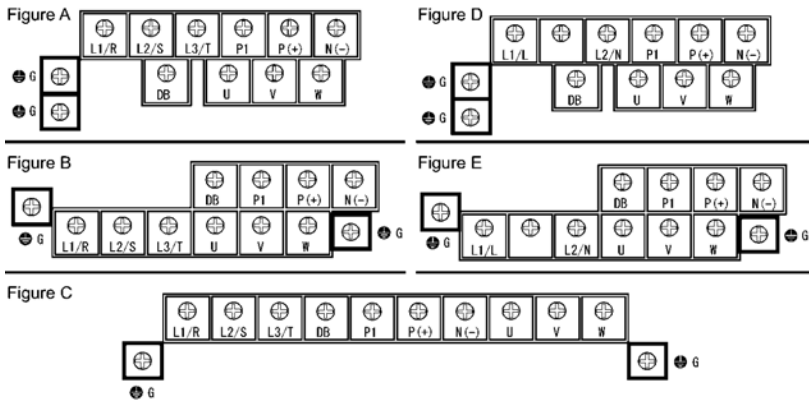

(Note 1) Terminal screw type is listed in the table below.

Inverter type	Screw type
FRN007E1E-2U	Cross
FRN010E1E-2U	
FRN015E1E-2U	Hxagon
FRN020E1E-2U	
FRN007E1E-4U	Flat
FRN010E1E-4U	
FRN015E1E-4U	Cross
FRN020E1E-4U	

(Note 2) Cables of EMC filter output are already connected to inverter input by factory default.

## (2) The control circuit terminals (common to all models)



CMY	Y1	Y2	C1	I1	FM	CM	X1	X2	X3	X4	X5	PLC
-----	----	----	----	----	----	----	----	----	----	----	----	-----

I1	I2	I3	CM	FWD	REV
----	----	----	----	-----	-----

30A	30B	30C
-----	-----	-----

Screw size: M3 Tightening torque: 4.4 to 5.3 (lb-in) (0.5 to 0.6 (N-m))

Table 2.5 Control Circuit Terminal Block

Screwdriver type	Allowable wire size	Wire strip length 	Dimension of openings in the control circuit terminals for ferrule (for Europe type terminal block)* 
Flat screw driver 0.02 x 1.38 inch (0.6 x 3.5 mm)	AWG26 to AWG16 (0.14 to 1.5 mm <sup>2</sup> )	0.24 inch (6 mm)	0.1(W) x 0.07(H) inch (2.51 (W) x 1.76 (H) mm)

\* Manufacturer of ferrules: Phoenix Contact Inc. Refer to Table 2.6.

Table 2.6 Recommended Ferrule Terminals

Screw size	Type	
	With insulated collar	Without insulated collar
AWG24 (0.25 mm <sup>2</sup> )	AI0.25-6BU	-
AWG22 (0.34 mm <sup>2</sup> )	AI0.34-6TQ	A0.34-7
AWG20 (0.5 mm <sup>2</sup> )	AI0.5-6WH	A0.5-6
AWG18 (0.75 mm <sup>2</sup> )	AI0.75-6GY	A0.75-6
AWG16 (1.25 mm <sup>2</sup> )	AI1.5-6BK	A1.5-7

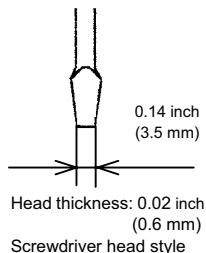

### 2.3.3 Recommended wire sizes

Table 2.7 lists the recommended wire sizes. The recommended wire sizes for the main circuits are examples of using HIV single wire for 75°C (167°F) at an ambient temperature of 50°C (122°F).

Table 2.7 Recommended Wire Sizes

Power supply voltage	Nominal applied motor	Inverter type	Recommended wire size AWG(mm <sup>2</sup> )*1						Control circuit			
			Main circuits									
			Main circuit power input [L1/R, L2/S, L3/T] [L1/L, L2/N]		Grounding [G]	Inverter output [U, V, W]	DCR [P1, P (+)]	Braking resistor [P(+), DB]				
			w/ DCR	w/o DCR								
Three-phase 230 V	1/8	FRNF12E1■-2U	14 (2)	14 (2)	14 (2)	14 (2)	14 (2)	14 (2)	20 (0.5) to 16 (1.25)			
	1/4	FRNF25E1■-2U										
	1/2	FRNF50E1■-2U										
	1	FRN001E1■-2U										
	2	FRN002E1■-2U										
	3	FRN003E1■-2U										
	5	FRN005E1■-2U										
	7.5	FRN007E1■-2U								11(3.5)	11(3.5)	11(3.5)
	10	FRN010E1■-2U								11(3.5)	9(5.5)	9(5.5)
15	FRN015E1■-2U	9(5.5)	5(14)	5(14)	8(8)	8(8)						
20	FRN020E1■-2U	5(14)	3(22)	3(22)	8(8)	5(14)	5(14)					
Three-phase 460 V	1/2	FRNF50E1■-4U	14 (2)	14 (2)	14 (2)	14 (2)	14 (2)	14 (2)	20 (0.5) to 16 (1.25)			
	1	FRN001E1■-4U										
	2	FRN002E1■-4U										
	3	FRN003E1■-4U										
	5	FRN005E1■-4U										
	7.5	FRN007E1■-4U										
	10	FRN010E1■-4U								11(3.5)	11(3.5)	11(3.5)
15	FRN015E1■-4U	11(3.5)	9(5.5)	9(5.5)	11(3.5)	9(5.5)						
20	FRN020E1■-4U	11(3.5)	9(5.5)	9(5.5)	11(3.5)	9(5.5)						
Three-phase 230 V	1/8	FRNF12E1■-7U	14 (2)	14 (2)	14 (2)	14 (2)	14 (2)	14 (2)	20 (0.5) to 16 (1.25)			
	1/4	FRNF25E1■-7U										
	1/2	FRNF50E1■-7U										
	1	FRN001E1■-7U										
	2	FRN002E1■-7U										
3	FRN003E1■-7U	11(3.5)										

DCR: DC reactor

\*1 Use the terminal crimp with an insulation sheath or with processing by the insulation tube. Use the insulated wire of 75°C (167°F), 600 V, HIV-insulated. This selection assumes the inverter is used in ambient temperature at 50°C (122°F).

**Note 1)** A box (■) in the above table replaces S or E depending on the enclosure.



### 2.3.4 Wiring precautions

Follow the rules below when performing wiring for the inverter.

- (1) Make sure that the power supply voltage is within the rated voltage range specified on the nameplate.
- (2) Be sure to connect the three-phase power wires to the main circuit power input terminals L1/R, L2/S and L3/T, or connect the single-phase power wires to the main circuit power input terminals L1/L and L2/N of the inverter. If the power wires are connected to other terminals, the inverter will be damaged when the power is turned ON.
- (3) Always connect the grounding terminal to prevent electric shock, fire or other disasters and to reduce electric noise.
- (4) Use crimp terminals covered with insulated sleeves for the main circuit terminal wiring to ensure a reliable connection.
- (5) Keep the power supply wiring (primary circuit) and motor wiring (secondary circuit) of the main circuit, and control circuit wiring as far away as possible from each other.

## WARNING

- When wiring the inverter to the power supply, insert a recommended molded case circuit breaker (MCCB) or residual-current-operated protective device (RCD)/a ground fault circuit interrupter (GFCI)(with overcurrent protection) in the path of each pair of power lines to inverters.
- Use wires in the specified size.
- Tighten terminals with specified torque.  
**Otherwise, fire could occur.**
- Do not connect a surge killer to the inverter's output circuit.
- Do not use one multicore cable in order to connect several inverters with motors.  
**Doing so could cause fire.**
- Ground the inverter in compliance with the national or local electric code.
- Be sure to connect the grounding wire for the inverters grounding terminal   
**Otherwise, electric shock or fire could occur.**
- Qualified electricians should carry out wiring.
- Be sure to perform wiring after turning the power off.  
**Otherwise, electric shock could occur.**
- Be sure to perform wiring after installing the inverter.  
**Otherwise, electric shock or injuries could occur.**
- Ensure that the number of input phases and the rated voltage of the product match the number of phases and the voltage of the AC power supply to which the product is to be connected.
- Do not connect the power supply wires to output terminals (U, V, and W).  
**Doing so could cause fire or an accident.**

### 2.3.5 Wiring for main circuit terminals and grounding terminals

Table 2.8 shows the main circuit power terminals and grounding terminals.

Table 2.8 Symbols, Names and Functions of the Main Circuit Power Terminals

Symbol	Name	Functions
L1/R, L2/S, L3/T or L1/L, L2/N	Main circuit power inputs	Connect the three-phase input power lines or single-phase input power lines
U, V, W	Inverter outputs	Connect a three-phase motor.
P1, P(+)	DC reactor connection	Connect an optional DC reactor (DCR) for improving power factor.
P(+), DB	DC braking resistor	Connect an optional braking resistor.
P(+), N(-)	DC link bus	Connect a DC link bus of other inverter(s). An optional regenerative converter is also connectable to these terminals.
	Grounding for inverter and motor	Grounding terminals for the inverter's chassis (or case) and motor. Earth one of the terminals and connect the grounding terminal of the motor. Inverters provide a pair of grounding terminals that function equivalently.

Follow the procedure below for wiring and configuration of the inverter. Figure 2.9 illustrates the wiring procedure with peripheral equipment.

Wiring procedure

- ① Grounding terminals (⊕G)
- ② Inverter output terminals (U, V, W, and ⊕G)
- ③ DC reactor connection terminals (P1 and P(+))\*
- ④ DC braking resistor connection terminals (P(+), DB)\*
- ⑤ DC link bus terminals (P(+) and N(-))\*
- ⑥ Main circuit power input terminals (L1/R, L2/S and L3/T, or L1/L and L2/N)

\* Perform wiring as necessary

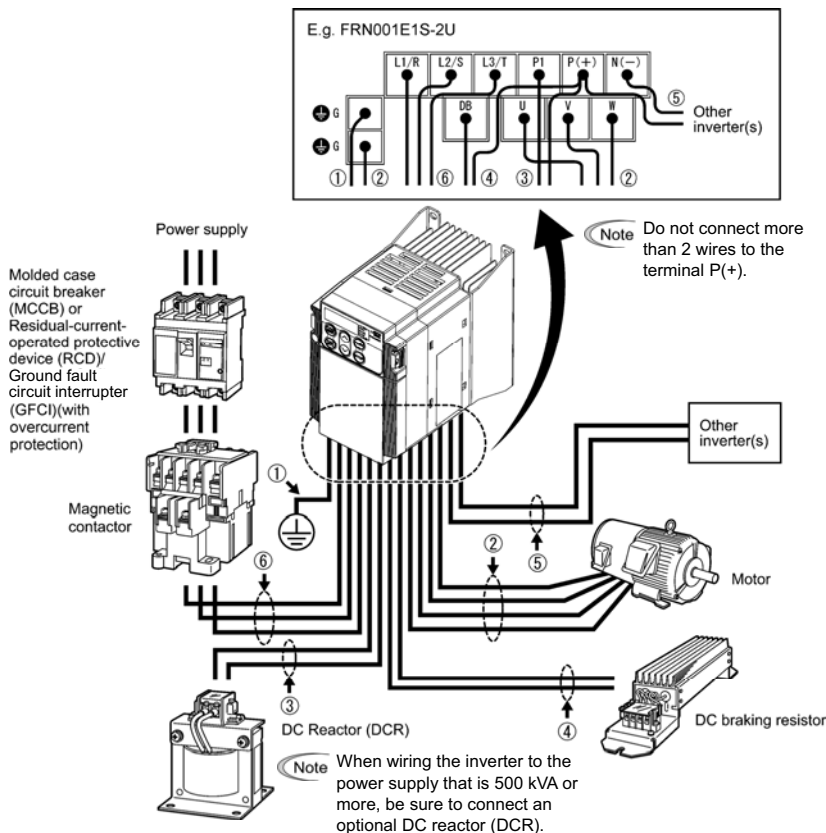

Figure 2.9 Wiring Procedure for Peripheral Equipment

## ① Grounding terminals (⊕G)

Be sure to ground either of the two grounding terminals for safety and noise reduction. The inverter is designed to use with a safety grounding to avoid electric shock, fire and other disasters.

Grounding terminals should be grounded as follows:

- 1) Ground the inverter in compliance with the national or local electric code.
- 2) Use a thick grounding wire with a large surface area and keep the wiring length as short as possible.

## ② Inverter output terminals, U, V, W and grounding terminals (⊕G)

Inverter's output terminals should be connected as follows:

- 1) Connect the three wires of the three-phase motor to terminals U, V, and W, aligning phases each other.
- 2) Connect the secondary grounding wire to the grounding terminal (⊕G).

### Note

- The wiring length between the inverter and motor should not exceed 164ft (50 m), when they are connected directly. If the wiring length exceeds 164ft (50 m), an output circuit filter (option) should be inserted. (E.g. total power cable length is 1300ft (400 m) as shown in the figure below.)
- Do not use one multicore cable to connect several inverters with motors even if some possible combinations of inverters and motors are considered.

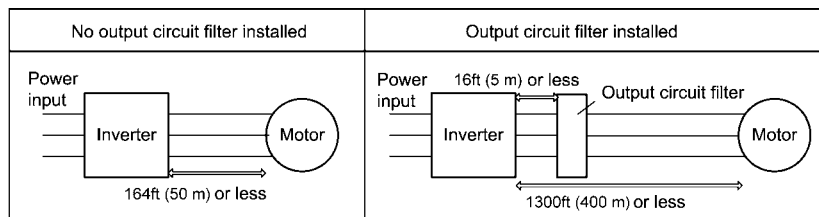

### Note

- Do not connect a power factor correcting capacitor or surge absorber to the inverter's output lines (secondary circuit).
- If the wiring length is long, the stray capacitance between the wires will increase, resulting in an outflow of the leakage current. It will activate the overcurrent protection, increase the leakage current, or will not assure the accuracy of the current display. In the worst case, the inverter could be damaged.
- If more than one motor is to be connected to a single inverter, the wiring length should be the sum of the length of the wires to the motors.



### **Driving 460 V class series motor**

- If a thermal relay is installed in the path between the inverter and the motor to protect the motor from overheating, the thermal relay may malfunction even with a wiring length shorter than 164ft (50 m). In this situation, add an output circuit filter (option) or lower the carrier frequency (Function code F26).
- If the motor is driven by a PWM-type inverter, surge voltage that is generated by switching the inverter component may be superimposed on the output voltage and may be applied to the motor terminals. Particularly if the wiring length is long, the surge voltage may deteriorate the insulation resistance of the motor. Consider any of the following measures.
  - Use a motor with insulation that withstands the surge voltage. (All Fuji standard motors feature insulation that withstands the surge voltage.)
  - Connect an output circuit filter (option) to the output terminals (secondary circuits) of the inverter.
  - Minimize the wiring length between the inverter and motor (33ft (10 m) to 66ft (20 m) or less).



### **Wiring length for EMC filter built-in type**

- When the wiring length between the inverter and motor exceeds 33ft (10 m), the filter circuit may be overheated and damaged due to increase of leakage current. To reduce the leakage current, set the motor sound (carrier frequency) to 2 kHz or below with function code F26.

### **③ DC reactor terminals, P1 and P (+)**

- 1) Remove the jumper bar from terminals P1 and P(+).
- 2) Connect a DC reactor (option) to terminals P1 and P(+).



- The wiring length should be 10 m or below.
- Do not remove the jumper bar if a DC reactor (DCR) is not going to be used.
- If a converter is connected, you do not need to connect a DC reactor (DCR).

## **WARNING**

When wiring the inverter to the power supply that is 500 kVA or more, be sure to connect an optional DC reactor (DCR).

**Otherwise, fire could occur.**

### **④ DC braking resistor terminals, P(+) and DB**

- 1) Connect a DC braking resistor (option) to terminals P(+) and DB.
- 2) When using an external braking resistor, arrange the inverter and braking resistor to keep the wiring length to 16ft (5 m) or less and twist the two wires or route them together in parallel.

## **WARNING**

Never insert a DC braking resistor between the terminals P(+) and N(-), P1 and N(-), P(+) and P1, DB and N(-), or P1 and DB.

**Doing so could cause fire.**

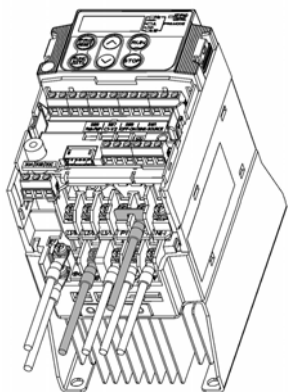

Figure 2.10 Braking Resistor Connection without DC Reactor (DCR)

**When a DC reactor (DCR) is not connected together with the braking resistor**

- 1) Remove the screws from terminals P1 and P(+), together with the jumper bar.
- 2) Put the wire from terminal P of the braking resistor and the jumper bar on terminal P(+) in this order, then secure them with the screw removed in 1) above.
- 3) Tighten the screw on terminal P1.
- 4) Connect the wire from terminal DB of the braking resistor to the DB of the inverter.

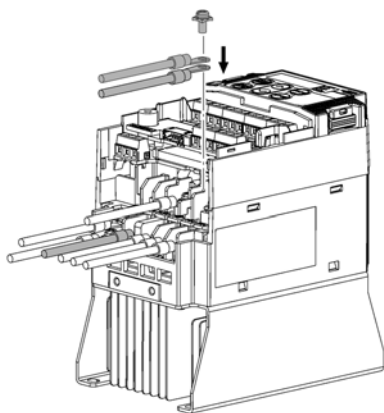

Figure 2.11 Braking Resistor Connection with DC Reactor (DCR)

**When connecting a DC reactor (DCR) together with the braking resistor**

- 1) Remove the screw from terminal P(+).
- 2) Overlap the DC reactor (DCR) wire and braking resistor wire (P) as shown at left and then secure them to terminal P(+) of the inverter with the screw.
- 3) Connect the wire from terminal DB of the braking resistor to terminal DB of the inverter.
- 4) Do not use the jumper bar.

**⑤ DC link bus terminals, P (+) and N (-)**

These are provided for the DC link bus powered system. Connect these terminals with terminals P(+) and N (-) of other inverters.

**Note** Consult your Fuji Electric representative if these terminals are to be used.

⑥ **Main circuit power input terminals, L1/R, L2/S, and L3/T (three-phase input), or L1/L and L2/N (single-phase input)**

- 1) For safety, make sure that the molded case circuit breaker (MCCB) or magnetic contactor (MC) is turned off before wiring the main circuit power input terminals.
- 2) Connect the main circuit power supply wires (L1/R, L2/S and L3/T for three-phase input, or L1/L and L2/N for single-phase input) to the input terminals of the inverter via an MCCB or residual-current-operated protective device (RCD)/a ground fault circuit interrupter (GFCI)\*, and MC if necessary.

It is not necessary to align phases of the power supply wires and the input terminals of the inverter with each other.

\* With overcurrent protection



It is recommended that a magnetic contactor be inserted that can be manually activated. This is to allow you to disconnect the inverter from the power supply in an emergency (e.g., when the protective function is activated) so as to prevent a failure or accident from causing the secondary problems.

### 2.3.6 Wiring for control circuit terminals

#### **WARNING**

In general, sheaths and covers of the control signal cables and wires are not specifically designed to withstand a high voltage (i.e., reinforced insulation is not applied). Therefore, if a control signal cable or wire comes into direct contact with a live conductor of the main circuit, the insulation of the sheath or the cover might break down, which would expose the signal wire to a high voltage of the main circuit. Make sure that the control signal cables and wires will not come into contact with live conductors of the main circuit.

**Failure to observe these precautions could cause electric shock and/or an accident.**

#### **CAUTION**

Noise may be emitted from the inverter, motor and wires.

Take appropriate measure to prevent the nearby sensors and devices from malfunctioning due to such noise.

**An accident could occur.**

Table 2.9 lists the symbols, names and functions of the control circuit terminals. The wiring to the control circuit terminals differs depending upon the setting of the function codes, which reflects the use of the inverter. Route wires properly to reduce the influence of noise.

Table 2.9 Symbols, Names and Functions of the Control Circuit Terminals

Classification	Symbol	Name	Functions
Analog input	[13]	Power supply for the potentiometer	Power supply (+10 VDC) for frequency command potentiometer (Potentiometer: 1 to 5k $\Omega$ ) The potentiometer of 1/2 W rating or more should be connected.
	[12]	Analog setting voltage input	(1) The frequency is commanded according to the external analog input voltage. <ul style="list-style-type: none"> <li>0 to <math>\pm 10</math> VDC/0 to <math>\pm 100\%</math> (Normal operation)</li> <li><math>\pm 10</math> to 0 VDC/0 to <math>\pm 100\%</math> (Inverse operation)</li> </ul> (2) Inputs setting signal (PID command value) or feedback signal.                     (3) Used as additional auxiliary setting to various frequency settings. <ul style="list-style-type: none"> <li>Input impedance: 22k<math>\Omega</math></li> <li>The maximum input is +15 VDC, however, the current larger than <math>\pm 10</math> VDC is handled as <math>\pm 10</math> VDC.</li> <li>Inputting a bipolar analog voltage (0 to <math>\pm 10</math> VDC) to terminal [12] requires setting function code C35 to "0."</li> </ul>
	[C1]	Analog setting current input (C1 function)	(1) The frequency is commanded according to the external analog input current. <ul style="list-style-type: none"> <li>4 to 20 mA DC/0 to 100% (Normal operation)</li> <li>20 to 4 mA DC/0 to 100 % (Inverse operation)</li> </ul> (2) Inputs setting signal (PID command value) or feedback signal.                     (3) Used as additional auxiliary setting to various frequency settings. <ul style="list-style-type: none"> <li>Input impedance: 250<math>\Omega</math></li> <li>Maximum input is +30 mA DC, however, the current larger than +20 mA DC is handled as +20 mA DC.</li> </ul>
		Analog setting voltage input (V2 function)	(1) The frequency is commanded according to the external analog input voltage. <ul style="list-style-type: none"> <li>0 to +10 VDC/0 to +100 % (Normal operation)</li> <li>+10 to 0 VDC/0 to +100 % (Inverse operation)</li> </ul> (2) Inputs setting signal (PID command value) or feedback signal.                     (3) Used as additional auxiliary setting to various frequency settings. <ul style="list-style-type: none"> <li>Input impedance: 22 k<math>\Omega</math></li> <li>Maximum input is +15 VDC, however, the voltage larger than +10 VDC is handled as +10 VDC.</li> </ul>
		PTC thermistor input (PTC function)	(1) Connects PTC (Positive Temperature Coefficient) thermistor for motor protection. The figure shown below illustrates the internal circuit diagram. To use the PTC thermistor, you must change data of the function code H26.
		The C1 function, V2 function, or PTC function can be assigned to terminal [C1]. Doing so requires setting the slide switch on the interface PCB and configuring the related function code. For details, refer to Section 2.3.7, "Setting up the slide switches".	
	[11]	Analog common	Common for analog input/output signals ([13], [12], [C1], and [FM]) Isolated from terminals [CM]s and [CMY].

Figure 2.12 Internal Circuit Diagram

Table 2.9 Symbols, Names and Functions of the Control Circuit Terminals (Continued)

Classification	Symbol	Name	Functions																										
Analog input			<ul style="list-style-type: none"> <li>- Since low level analog signals are handled, these signals are especially susceptible to the external noise effects. Route the wiring as short as possible (within 66ft (20 m)) and use shielded wires. In principle, ground the shielded sheath of wires; if effects of external inductive noises are considerable, connection to terminal [11] may be effective. As shown in Figure 2.13, ground the single end of the shield to enhance the shield effect.</li> <li>- Use a twin contact relay for low level signals if the relay is used in the control circuit. Do not connect the relay's contact to terminal [11].</li> <li>- When the inverter is connected to an external device outputting the analog signal, a malfunction may be caused by electric noise generated by the inverter. If this happens, according to the circumstances, connect a ferrite core (a toroidal core or an equivalent) to the device outputting the analog signal and/or connect a capacitor having the good cut-off characteristics for high frequency between control signal wires as shown in Figure 2.14.</li> <li>- Do not apply a voltage of +7.5 VDC or higher to terminal [C1] when you assign the terminal [C1] to C1 function. Doing so could damage the internal control circuit.</li> </ul>																										
Figure 2.13 Connection of Shielded Wire			Figure 2.14 Example of Electric Noise Reduction																										
Digital input	[X1]	Digital input 1	<p>(1) Various signals such as coast-to-stop, alarm from external equipment, and multi-frequency commands can be assigned to terminals [X1] to [X5], [FWD] and [REV] by setting function codes E01 to E05, E98, and E99. For details, refer to Chapter 5, Section 5.2 "Overview of Function Codes."</p> <p>(2) Input mode, i.e. SINK/SOURCE, is changeable by using the internal slide switch. (Refer to Section 2.3.7, "Setting up the slide switches.")</p> <p>(3) Switches the logic value (1/0) for ON/OFF of the terminals [X1] to [X5], [FWD], or [REV]. If the logic value for ON of the terminal [X1] is 1 in the normal logic system, for example, OFF is 1 in the negative logic system and vice versa.</p> <p>(4) The negative logic system never applies to the terminals assigned for <b>FWD</b> and <b>REV</b>.</p>																										
	[X2]	Digital input 2																											
	[X3]	Digital input 3																											
	[X4]	Digital input 4																											
	[X5]	Digital input 5																											
	[FWD]	Run forward command	(Digital input circuit specifications)																										
[REV]	Run reverse command																												
			<table border="1"> <thead> <tr> <th colspan="2">Item</th> <th>Min.</th> <th>Max.</th> </tr> </thead> <tbody> <tr> <td rowspan="2">Operation voltage (SINK)</td> <td>ON level</td> <td>0 V</td> <td>2 V</td> </tr> <tr> <td>OFF level</td> <td>22 V</td> <td>27 V</td> </tr> <tr> <td rowspan="2">Operation voltage (SOURCE)</td> <td>ON level</td> <td>22 V</td> <td>27 V</td> </tr> <tr> <td>OFF level</td> <td>0 V</td> <td>2 V</td> </tr> <tr> <td colspan="2">Operation current at ON (Input voltage is at 0 V)</td> <td>2.5 mA</td> <td>5 mA</td> </tr> <tr> <td colspan="2">Allowable leakage current at OFF</td> <td>-</td> <td>0.5 mA</td> </tr> </tbody> </table>	Item		Min.	Max.	Operation voltage (SINK)	ON level	0 V	2 V	OFF level	22 V	27 V	Operation voltage (SOURCE)	ON level	22 V	27 V	OFF level	0 V	2 V	Operation current at ON (Input voltage is at 0 V)		2.5 mA	5 mA	Allowable leakage current at OFF		-	0.5 mA
Item		Min.	Max.																										
Operation voltage (SINK)	ON level	0 V	2 V																										
	OFF level	22 V	27 V																										
Operation voltage (SOURCE)	ON level	22 V	27 V																										
	OFF level	0 V	2 V																										
Operation current at ON (Input voltage is at 0 V)		2.5 mA	5 mA																										
Allowable leakage current at OFF		-	0.5 mA																										
Figure 2.15 Digital Input Circuit																													



Table 2.9 Symbols, Names and Functions of the Control Circuit Terminals (Continued)

Classification	Symbol	Name	Functions
[PLC]	PLC signal power		Connects to PLC output signal power supply. (Rated voltage: +24 VDC (Maximum 50 mA DC); Allowable range: +22 to +27 VDC) This terminal also supplies a power to the circuitry connected to the transistor output terminals [Y1] and [Y2]. Refer to "Analog output, pulse output, transistor output, and relay output terminals" in this Section for more.
[CM]	Digital input common		Two common terminals for digital input signals These terminals are electrically isolated from the terminals [11]s and [CMY].

**Tip**

■ Using a relay contact to turn [X1], [X2], [X3], [X4], [X5], [FWD], or [REV] ON or OFF  
Figure 2.16 shows two examples of a circuit that uses a relay contact to turn control signal input [X1], [X2], [X3], [X4], [X5], [FWD], or [REV] ON or OFF. In circuit (a), the slide switch SW1 has been turned to SINK, whereas in circuit (b) it has been turned to SOURCE.

**Note:** To configure this kind of circuit, use a highly reliable relay.  
(Recommended product: Fuji control relay Model HH54PW)

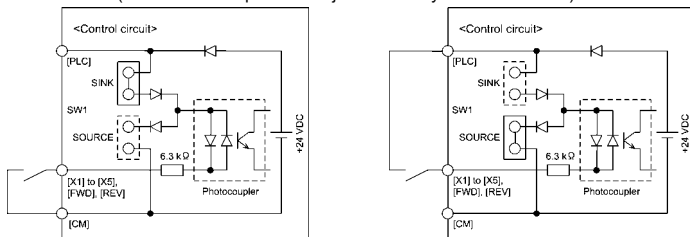

(a) With the switch turned to SINK

(b) With the switch turned to SOURCE

Figure 2.16 Circuit Configuration Using a Relay Contact

**Tip**

■ Using a programmable logic controller (PLC) to turn [X1], [X2], [X3], [X4], [X5], [FWD], or [REV] ON or OFF

Figure 2.17 shows two examples of a circuit that uses a programmable logic controller (PLC) to turn control signal input [X1], [X2], [X3], [X4], [X5], [FWD], or [REV] ON or OFF. In circuit (a), the slide switch SW1 has been turned to SINK, whereas in circuit (b) it has been turned to SOURCE.

In circuit (a) below, short-circuiting or opening the transistor's open collector circuit in the PLC using an external power supply turns ON or OFF control signal [X1], [X2], [X3], [X4], [X5], [FWD], or [REV]. When using this type of circuit, observe the following:

- Connect the + node of the external power supply (which should be isolated from the PLC's power) to terminal [PLC] of the inverter.
- Do not connect terminal [CM] of the inverter to the common terminal of the PLC.

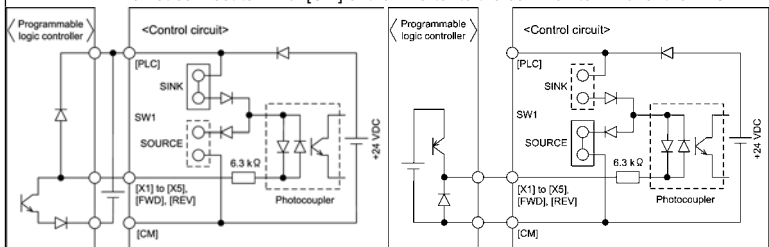

(a) With the switch turned to SINK

(b) With the switch turned to SOURCE

Figure 2.17 Circuit Configuration Using a PLC

☞ For details about the slide switch setting, refer to Section 2.3.7, "Setting up the slide switches".)

Table 2.9 Symbols, Names and Functions of the Control Circuit Terminals (Continued)

Classification	Symbol	Name	Functions
Analog output	[FM]	Analog monitor (FMA function)	<p>The monitor signal for analog DC voltage (0 to +10 V) is output. You can select FMA function with slide switch SW6 on the interface PCB, and change the data of the function code F29. You can also select the signal functions following with function code F31.</p> <ul style="list-style-type: none"> <li>• Output frequency 1 (Before slip compensation)</li> <li>• Output frequency 2 (After slip compensation)</li> <li>• Output current</li> <li>• Load factor</li> <li>• PG feedback value</li> <li>• Motor output</li> <li>• PID output (MV)</li> <li>• Output voltage</li> <li>• Input power</li> <li>• DC link bus voltage</li> <li>• Calibration</li> <li>• Output torque</li> <li>• PID feedback amount (PV)</li> <li>• Universal AO</li> <li>• PID command (SV)</li> </ul> <p>* Input impedance of external device: Min. 5k<math>\Omega</math> (0 to +10 VDC output)</p> <p>* While the terminal is outputting 0 to +10 VDC, it is capable to drive up to two meters with 10k<math>\Omega</math> impedance. (Adjustable range of the gain: 0 to 300%)</p>
	Pulse output		Pulse monitor (FMP function)
[11]		Analog common	<p>Two common terminals for analog input and output signal terminals. These terminals are electrically isolated from terminals [CM]s and [CMY].</p>
		Do not connect a meter with pull-up resistor to the input (primary) side.	

Table 2.9 Symbols, Names and Functions of the Control Circuit Terminals (Continued)

Classification	Symbol	Name	Functions											
Transistor output	[Y1]	Transistor output 1	<p>(1) Various signals such as inverter running, speed/freq. arrival and overload early warning can be assigned to any terminals, [Y1] and [Y2] by setting function code E20 and E21. Refer to Chapter 5, Section 5.2 "Overview of Function Codes" for details.</p> <p>(2) Switches the logic value (1/0) for ON/OFF of the terminals between [Y1], [Y2], and [CMY]. If the logic value for ON between [Y1], [Y2], and [CMY] is 1 in the normal logic system, for example, OFF is 1 in the negative logic system and vice versa.</p> <p>(Transistor output circuit specification)</p>  <table border="1" data-bbox="657 422 906 633"> <thead> <tr> <th>Item</th> <th>Max.</th> </tr> </thead> <tbody> <tr> <td rowspan="2">Operation voltage</td> <td>ON level</td> <td>3 V</td> </tr> <tr> <td>OFF level</td> <td>27 V</td> </tr> <tr> <td>Maximum motor current at ON</td> <td>50 mA</td> </tr> <tr> <td>Leakage current at OFF</td> <td>0.1 mA</td> </tr> </tbody> </table>	Item	Max.	Operation voltage	ON level	3 V	OFF level	27 V	Maximum motor current at ON	50 mA	Leakage current at OFF	0.1 mA
	Item	Max.												
Operation voltage	ON level	3 V												
	OFF level	27 V												
Maximum motor current at ON	50 mA													
Leakage current at OFF	0.1 mA													
	[Y2]	Transistor output 2												
	[CMY]	Transistor output common	<p>Common terminal for transistor output signal terminals</p> <p>This terminal is electrically isolated from terminals, [CM]s and [11]s.</p>											
	Tip	<p>■ Connecting Programmable Logic Controller (PLC) to Terminal [Y1] or [Y2]</p> <p>Figure 2.19 shows two examples of circuit connection between the transistor output of the inverter's control circuit and a PLC. In example (a), the input circuit of the PLC serves as a SINK for the control circuit output, whereas in example (b), it serves as a SOURCE for the output.</p>	 <p>(a) PLC serving as SINK</p> <p>(b) PLC serving as SOURCE</p>											

Figure 2.18 Transistor Output Circuit

Figure 2.19 shows examples of connection between the control circuit and a PLC.

**Note**

- When a transistor output drives a control relay, connect a surge-absorbing diode across relay's coil terminals.
- When any equipment or device connected to the transistor output needs to be supplied with DC power, feed the power (+24 VDC; allowable range: +22 to +27 VDC, 50 mA max.) through the [PLC] terminal. Short-circuit between the terminals [CMY] and [CM] in this case.

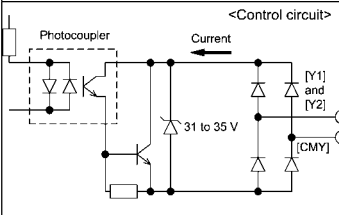
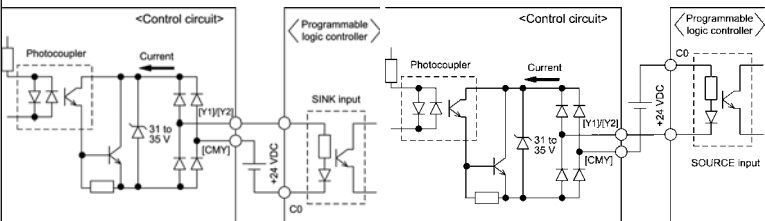
Table 2.9 Symbols, Names and Functions of the Control Circuit Terminals (Continued)

Classification	Symbol	Name	Functions
Relay output	[30A/B/C]	Alarm relay output (for any error)	<p>(1) Outputs a contact signal (SPDT) when a protective function has been activated to stop the motor. Contact rating: <math>250 \text{ VAC}, 0.3 \text{ A}, \cos \phi = 0.3, 48 \text{ VDC}, 0.5 \text{ A}</math></p> <p>(2) Any one of output signals assigned to terminals [Y1] and [Y2] can also be assigned to this relay contact to use it for signal output.</p> <p>(3) Switching of the normal/negative logic output is applicable to the following two contact output modes: "Between terminals [30A] and [30C] is closed (excited) for ON signal output (Active ON)" or "Between terminals [30A] and [30C] is open (non-excited) for ON signal output (Active OFF)."</p>
Communication	RJ-45 connect or for the keypad	Standard RJ-45 connector	<p>(1) Used to connect the inverter with the keypad. The inverter supplies the power to the keypad through the pins specified below. The extension cable for remote operation also uses wires connected to these pins for supplying the keypad power.</p> <p>(2) Remove the keypad from the standard RJ-45 connector, and connect the RS-485 communications cable to control the inverter through the PC or PLC (Programmable Logic Controller). Refer to Section 2.3.7, "Setting up the slide switches" for setting of the terminating resistor.</p> <div style="text-align: center;"> </div> <p>Figure 2.20 RJ-45 Connector and its Pin Assignment*</p> <p>* Pins 1, 2, 7, and 8 are exclusively assigned to power lines for the standard keypad and multi-function keypad, so do not use those pins for any other equipment.</p>



Note

- Route the wiring of the control circuit terminals as far from the wiring of the main circuit as possible. Otherwise electric noise may cause malfunctions.
- Fix the control circuit wires inside the inverter to keep them away from the live parts of the main circuit (such as the terminal block of the main circuit).
- The RJ-45 connector pin assignment on the FRENIC-Multi series is different from that on the FVR-E11S series. Do not connect to the keypad of the FVR-E11S series of inverter. Doing so could damage the internal control circuit.



Note

**Mounting the interface printed circuit board (interface PCB)**

- Usually, you do not need to remove the interface PCB. However, if you remove the interface PCB, be sure to mount the interface PCB by putting hooks provided on the interface PCB into the inverter until you have heard click sound.

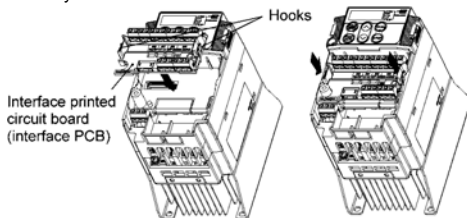

Figure 2.21 Mounting the Interface Printed Circuit Board (Interface PCB)

### 2.3.7 Setting up the slide switches

## ⚠ WARNING

Before changing the switches, turn OFF the power and wait more than five minutes. Make sure that the LED monitor is turned OFF. Further, make sure, using a circuit tester or a similar instrument, that the DC link bus voltage between the terminals P (+) and N (-) has dropped below the safe voltage (+25 VDC).

**An electric shock may result if this warning is not heeded as there may be some residual electric charge in the DC bus capacitor even after the power has been turned OFF.**

#### ■ Switching the slide switches

Switching the slide switches with excessive power, the switches may be damaged.

Switching the slide switches using precision screwdriver, etc. and treat it without damages.

(Do not switching the slide switches with an acute thing such as needles.)

#### ■ Setting up the slide switches

Switching the slide switches located on the control PCB and interface PCB allows you to customize the operation mode of the analog output terminals, digital I/O terminals, and communications ports. The locations of those switches are shown in Figure 2.22.

To access the slide switches, remove the terminal cover and keypad.

 For details on how to remove the terminal cover, refer to Section 2.3.1, "Removing the terminal cover and main circuit terminal block cover."

Table 2.10 lists function of each slide switch.

Table 2.10 Function of Each Slide Switch

Switch	Function																				
① SW1	Switches the service mode of the digital input terminals between SINK and SOURCE. <ul style="list-style-type: none"> <li>To make the digital input terminal [X1] to [X5], [FWD] or [REV] serve as a current sink, turn SW1 to the SINK position.</li> <li>To make them serve as a current source, turn SW1 to the SOURCE position.</li> </ul>																				
② SW3	Switches the terminating resistor of RS-485 communications port on the inverter on and off. <ul style="list-style-type: none"> <li>To connect a keypad to the inverter, turn SW3 to OFF. (Factory default)</li> <li>If the inverter is connected to the RS-485 communications network as a terminating device, turn SW3 to ON.</li> </ul>																				
③ SW6	Switches the output mode of the output terminal [FM] between analog voltage and pulse output. When changing this switch setting, also change the data of function code F29. <table border="1" style="margin-left: 20px;"> <thead> <tr> <th></th> <th>SW6</th> <th>Data for F29</th> </tr> </thead> <tbody> <tr> <td>Analog voltage output (Factory default)</td> <td>FMA</td> <td>0</td> </tr> <tr> <td>Current output</td> <td>FMP</td> <td>2</td> </tr> </tbody> </table>		SW6	Data for F29	Analog voltage output (Factory default)	FMA	0	Current output	FMP	2											
	SW6	Data for F29																			
Analog voltage output (Factory default)	FMA	0																			
Current output	FMP	2																			
④ SW7 SW8	Switches property of the input terminal [C1] for C1, V2, or PTC. When changing this switch setting, also change the data of function code E59 and H26. <table border="1" style="margin-left: 20px;"> <thead> <tr> <th></th> <th>SW7</th> <th>SW8</th> <th>Data for E59</th> <th>Data for H26</th> </tr> </thead> <tbody> <tr> <td>Analog frequency setting in current (Factory default)</td> <td>C1</td> <td>OFF</td> <td>0</td> <td>0</td> </tr> <tr> <td>Analog frequency setting in voltage</td> <td>V2</td> <td>OFF</td> <td>1</td> <td>0</td> </tr> <tr> <td>PTC thermistor input</td> <td>C1</td> <td>ON</td> <td>0</td> <td>1</td> </tr> </tbody> </table>		SW7	SW8	Data for E59	Data for H26	Analog frequency setting in current (Factory default)	C1	OFF	0	0	Analog frequency setting in voltage	V2	OFF	1	0	PTC thermistor input	C1	ON	0	1
	SW7	SW8	Data for E59	Data for H26																	
Analog frequency setting in current (Factory default)	C1	OFF	0	0																	
Analog frequency setting in voltage	V2	OFF	1	0																	
PTC thermistor input	C1	ON	0	1																	

Figure 2.22 shows the location of slide switches for the input/output terminal configuration.

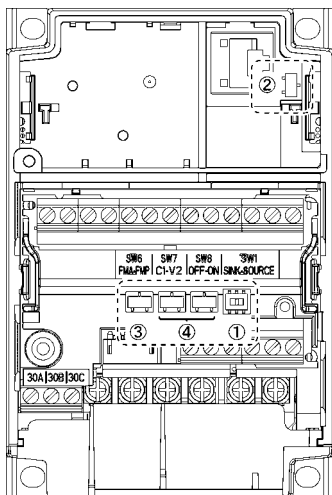

Switching example

② SW3

OFF	ON
Factory default	

	③	④		①
	SW6	SW7	SW8	SW1*
Factory default	FMA ← 	C1 ← 	OFF ← 	SINK ← 
	FMP → 	V2 → 	ON → 	SOURCE → 

Figure 2.22 Location of the Slide Switches

## 2.4 Mounting and Connecting a Keypad

### 2.4.1 Mounting style and parts needed for connection

#### (1) Mounting style

You can mount a keypad in any style described below.

- Mounting a keypad on the panel wall (Refer to Figure 2.23.)
- Installing a keypad at a remote site (e.g. for operation on hand) (Refer to Figure 2.24.)

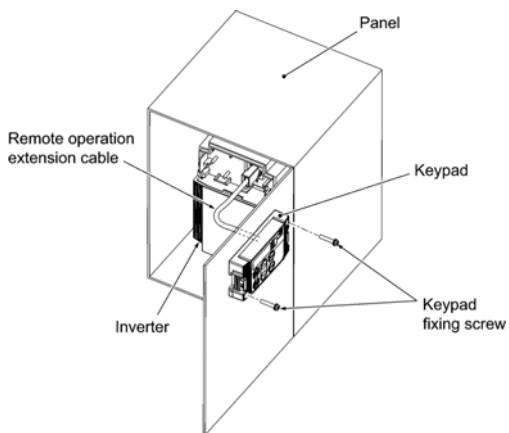

Figure 2.23 Mounting Keypad on the Panel Wall

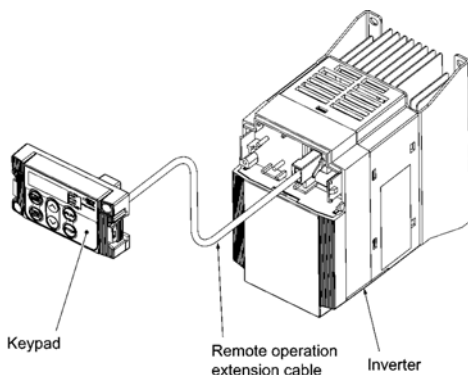

Figure 2.24 Installing Keypad at a Remote Site (e.g. for Operation on Hand)

## (2) Parts needed for connection

To mount/install a keypad on a place other than an inverter, parts listed below are needed.

Parts name	Model	Remarks
Extension cable (Note)	CB-5S, CB-3S and CB-1S	3 cables available in length of 16ft (5m), 9.8ft (3m), and 3.3ft (1m).
Fixing screw	M3 × 16	Accessories
Keypad rear cover		Accessories

(Note) When using an off-the-shelf LAN cable, use a 10BASE-T/100BASE-TX straight type cable compliant to US ANSI TIA/EIA-568A Category 5. (Less than 66ft(20m))

Recommended LAN cable

Manufacturer: SANWA Supply Co., LTD.

Model: KB-10T5-01K (3.3ft(1m))

KB-STP-01K (3.3ft(1m)) (Shielded LAN cable compliant to EMC Directive)

### 2.4.2 Mounting/installing steps

#### ■ Mounting a keypad on the panel wall

- ① Pull the keypad toward you while holding down the hooks on the keypad.

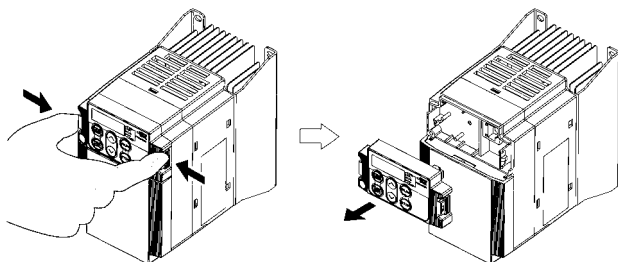

Figure 2.25 Removing a Keypad

- ② Fix the keypad rear cover to the keypad.

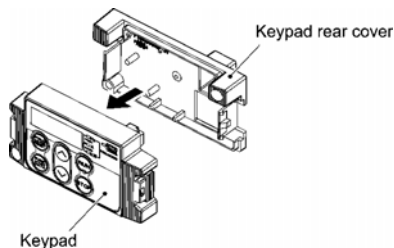

Figure 2.26 Fixing the Keypad Rear Cover for Remote Keypad Operation



- ③ Make a cut-out on the panel wall. For details, refer to Chapter 8, Section 8.4.2 "Standard keypad."
- ④ To mount the keypad on the panel, fix it firmly using a pair of M3 screws put through the taps shown below. (Figure 2.27.)  
(Tightening torque: 6.2 lb-in (0.7 N·m))

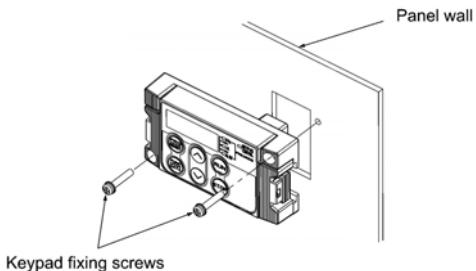

Figure 2.27 Mounting a Keypad on the Panel Wall

- ⑤ Connect an extension cable (CB-5S, CB-3S or CB-1S) or off-the-shelf straight LAN cable to RJ-45 connectors (Modular jacks) on the keypad and inverter (standard RS-485 port.) (Refer to Figure 2.28)

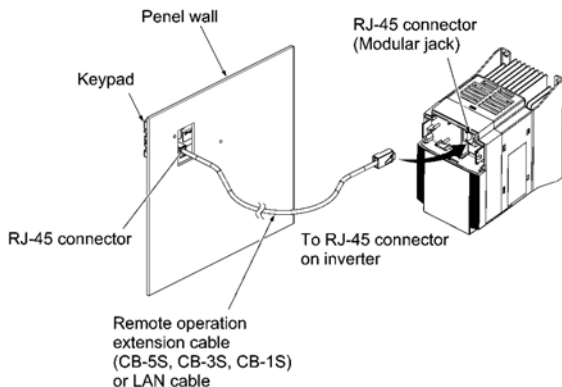

Figure 2.28 Connecting a Keypad and an Inverter's Standard RS-485 port

■ **Installing a keypad at a remote site (e.g. for operation on hand)**

Follow the step ⑤ in ■ Mounting a keypad on the panel wall.

## 2.5 Cautions Relating to Harmonic Component, Noise, and Leakage Current

### (1) Harmonic component

Input current to an inverter includes a harmonic component, which may affect other loads and power factor correcting capacitors that are connected to the same power supply as the inverter. If the harmonic component causes any problems, connect a DC reactor (option) to the inverter. It may also be necessary to connect an AC reactor to the power factor correcting capacitors.

### (2) Noise

If noise generated from the inverter affects other devices, or that generated from peripheral equipment causes the inverter to malfunction, follow the basic measures outlined below.

- 1) If noise generated from the inverter affects the other devices through power wires or grounding wires:
  - Isolate the grounded metal frames of the inverter from those of the other devices.
  - Connect a noise filter to the inverter power wires.
  - Isolate the power system of the other devices from that of the inverter with an insulated transformer.
- 2) If induction or radio noise generated from the inverter affects other devices through power wires or grounding wires:
  - Isolate the main circuit wires from the control circuit wires and other device wires.
  - Put the main circuit wires through a metal conduit pipe, and connect the pipe to the ground near the inverter.
  - Install the inverter into the metal switchboard and connect the whole board to the ground.
  - Connect a noise filter to the inverter power wires.
- 3) When implementing measures against noise generated from peripheral equipment:
  - For the control signal wires, use twisted or shielded-twisted wires. When using shielded-twisted wires, connect the shield of the shielded wires to the common terminals of the control circuit or ground.
  - Connect a surge absorber in parallel with magnetic contactor's coils or other solenoids (if any).

### (3) Leakage current

A high frequency current component generated by insulated gate bipolar transistors (IGBTs) switching ON/OFF inside the inverter becomes leakage current through stray capacitance of inverter input and output wires or a motor. If any of the problems listed below occur, take an appropriate measure against them.

Table 2.11 Leakage Current Countermeasures

Problem	Measures
A residual-current-operated protective device (RCD) or a ground fault circuit interrupter (GFCI) that is connected to the input (primary) side has tripped.	<ol style="list-style-type: none"><li>1) Decrease the carrier frequency.</li><li>2) Make the wires between the inverter and motor shorter.</li><li>3) Use an RCD or GFCI with lower sensitivity than the one currently used.</li><li>4) Use an RCD or GFCI that features measures against the high frequency current component (Fuji SG and EG series).</li></ol>
An external thermal relay was activated.	<ol style="list-style-type: none"><li>1) Decrease the carrier frequency.</li><li>2) Increase the settling current of the thermal relay.</li><li>3) Use the electronic thermal overload protection built in the inverter, instead of the external thermal relay.</li></ol>

## Chapter 3 OPERATION USING THE KEYPAD

### 3.1 LED Monitor, Keys and LED Indicators on the Keypad

As shown at the right, the keypad consists of a four-digit LED monitor, six keys, and five LED indicators.

The keypad allows you to run and stop the motor, monitor running status, and switch to the menu mode. In the menu mode, you can set the function code data, monitor I/O signal states, maintenance information, and alarm information.

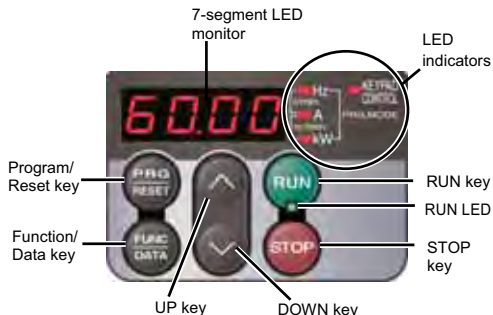



Table 3.1 Overview of Keypad Functions

Item	LED Monitor, Keys, and LED Indicators	Functions
LED Monitor		<p>Four-digit, 7-segment LED monitor which displays the followings according to the operation modes.</p> <ul style="list-style-type: none"> <li>■ In Running mode: Running status information (e.g., output frequency, current, and voltage)</li> <li>■ In Programming mode: Menus, function codes and their data</li> <li>■ In Alarm mode: Alarm code, which identifies the alarm factor if the protective function is activated.</li> </ul>
Operation Keys		<p>Program/Reset key which switches the operation modes of the inverter.</p> <ul style="list-style-type: none"> <li>■ In Running mode: Pressing this key switches the inverter to Programming mode.</li> <li>■ In Programming mode: Pressing this key switches the inverter to Running mode.</li> <li>■ In Alarm mode: Pressing this key after removing the alarm factor will switch the inverter to Running mode.</li> </ul>
		<p>Function/Data key which switches the operation you want to do in each mode as follows:</p> <ul style="list-style-type: none"> <li>■ In Running mode: Pressing this key switches the information to be displayed concerning the status of the inverter (output frequency (Hz), output current (A), output voltage (V), etc.).</li> <li>■ In Programming mode: Pressing this key displays the function code and sets the data entered with  and  keys.</li> <li>■ In Alarm mode: Pressing this key displays the details of the problem indicated by the alarm code that has come up on the LED monitor.</li> </ul>
		RUN key. Press this key to run the motor.
		STOP key. Press this key to stop the motor.
		UP and DOWN keys. Press these keys to select the setting items and change the function code data displayed on the LED monitor.

Table 3.1 Overview of Keypad Functions (Continued)

Item	LED Monitor, Keys, and LED Indicators	Functions					
LED Indicators	RUN LED	Lights when any run command to the inverter is active.					
	KEYPAD CONTROL LED	Lights when the inverter is ready to run with a run command entered by the  key (F02 = 0, 2, or 3). In Programming and Alarm modes, you cannot run the inverter even if the indicator lights.					
	Unit LEDs (3 LEDs)	<p>These three LED indicators identify the unit of numeral displayed on the LED monitor in running mode by combination of lit and unlit states of them. Unit: kW, A, Hz, r/min and m/min Refer to Chapter 3, Section 3.3.1 "Monitoring the running status" for details.</p> <p>While the inverter is in Programming mode, the LEDs of</p> <table style="float: right;"> <tr> <td><input checked="" type="checkbox"/></td> <td>Hz</td> </tr> <tr> <td><input type="checkbox"/></td> <td>A</td> </tr> <tr> <td><input checked="" type="checkbox"/></td> <td>kW</td> </tr> </table>	<input checked="" type="checkbox"/>	Hz	<input type="checkbox"/>	A	<input checked="" type="checkbox"/>
<input checked="" type="checkbox"/>	Hz						
<input type="checkbox"/>	A						
<input checked="" type="checkbox"/>	kW						

### Simultaneous keying

Simultaneous keying means pressing two keys at the same time. The FRENIC-Multi supports simultaneous keying as listed below. The simultaneous keying operation is expressed by a "+" letter between the keys throughout this manual.











(For example, the expression " +  keys" stands for pressing the  key while holding down the  key.)

Table 3.2 Simultaneous Keying

Operation mode	Simultaneous keying	Used to:
Programming mode	 +  keys	Change certain function code data. (Refer to codes F00, H03, H45, H97, J75, and J77 in Chapter 5 "FUNCTION CODES.")
	 +  keys	
Alarm mode	 +  keys	Switch to Programming mode without resetting alarms currently occurred.

## 3.2 Overview of Operation Modes

FRENIC-Multi features the following three operation modes:

- Running mode : This mode allows you to enter run/stop commands in regular operation. You can also monitor the running status in real time.
- Programming mode : This mode allows you to configure function code data and check a variety of information relating to the inverter status and maintenance.
- Alarm mode : If an alarm condition arises, the inverter automatically enters Alarm mode. In this mode, you can view the corresponding alarm code\* and its related information on the LED monitor.

\* Alarm code: Indicates the cause of the alarm condition that has triggered a protective function. For details, refer to Chapter 8, Section 8.5 "Protective Functions."

Figure 3.1 shows the status transition of the inverter between these three operation modes.

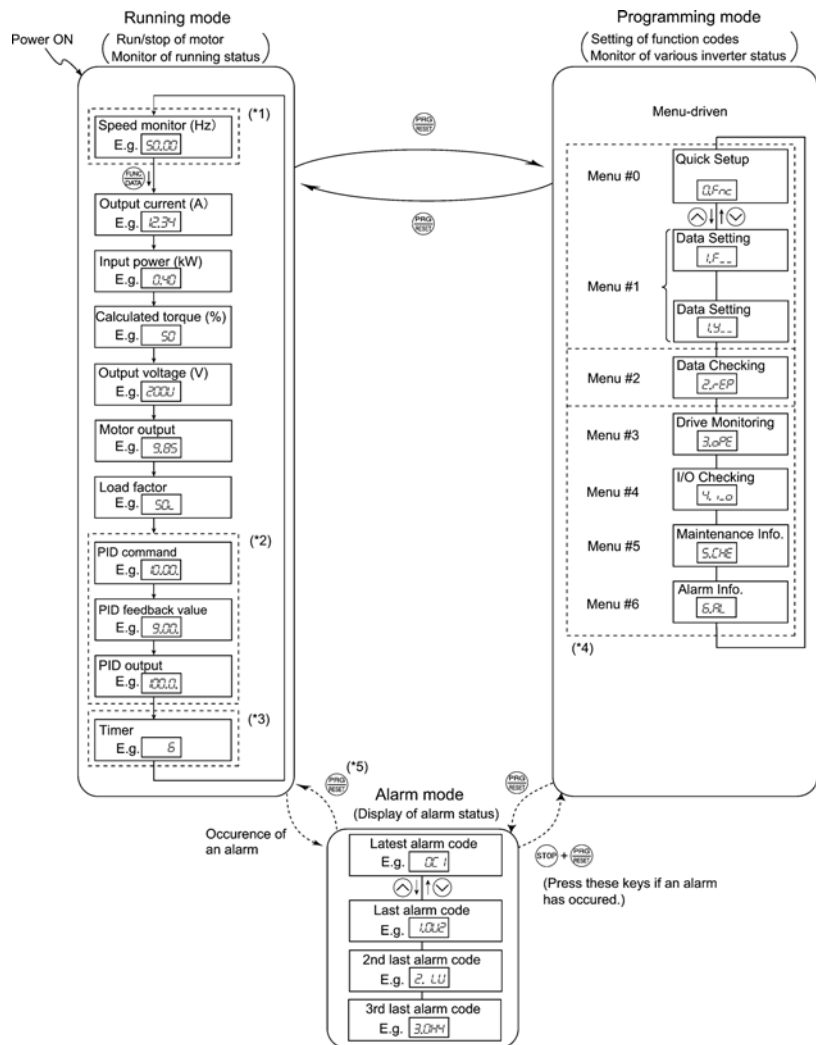

(\*1) The speed monitor allows you to select the desired one from the seven speed monitor items by using function code E48.

(\*2) Applicable only when PID control is active (J01 = 1, 2 or 3).

(\*3) The Timer screen appears only when the timer operation is enabled with function code C21.

(\*4) Applicable only when the full-menu mode is selected (E52 = 2).

(\*5) Pressing **STOP** key can reset an alarm only when the latest alarm is displayed on the LED monitor.

Figure 3.1 Transition between Basic Screens in Individual Operation Mode

### 3.3 Running Mode

When the inverter is turned ON, it automatically enters Running mode in which you can:

- (1) Monitor the running status (e.g., output frequency and output current),
- (2) Configure the reference frequency and other settings,
- (3) Run/stop the motor, and
- (4) Jog (inch) the motor.

#### 3.3.1 Monitoring the running status



In Running mode, the eleven items listed below can be monitored. Immediately after the inverter is turned ON, the monitor item specified by function code E43 is displayed. Press the  key to switch between monitor items. For details of switching the monitor item by using the  key, refer to "Monitor of running status" in Running mode in Figure 3.1.

Table 3.3 Monitoring Items



Monitor items	Display sample on the LED monitor *1	LED indicator ■: ON, □: OFF	Unit	Meaning of displayed value	Function code data for E43
Speed monitor	Function code E48 specifies what to be displayed on the LED monitor and LED indicators.				0
Output frequency (before slip compensation)	50.00	■Hz □A □kW	Hz	Frequency actually being output	(E48 = 0)
Output frequency (after slip compensation)	50.00	■Hz □A □kW	Hz	Frequency actually being output	(E48 = 1)
Reference frequency	50.00	■Hz □A □kW	Hz	Reference frequency being set	(E48 = 2)
Motor speed	1500	■Hz ■A □kW	r/min	Output frequency (Hz) × $\frac{120}{P01}$ For motor 2, read P01 as A15.	(E48 = 3)
Load shaft speed	300.0	■Hz ■A □kW	r/min	Output frequency (Hz) × E50	(E48 = 4)
Line speed	300.0	□Hz ■A ■kW	m/min	Output frequency (Hz) × E50	(E48 = 5)
Constant feeding rate time	50	□Hz □A □kW	min	$\frac{E50}{\text{Output frequency (Hz)} \times E39}$	(E48 = 6)
Output current	12.34	□Hz ■A □kW	A	Current output from the inverter in RMS	3
Output voltage *2	200V	□Hz □A □kW	V	Voltage output from the inverter in RMS	4
Calculated torque	50	□Hz □A □kW	%	Motor output torque in % (Calculated value)	8
Input power	10.25	□Hz □A ■kW	kW	Input power to the inverter	9

Table 3.3 Monitoring Items (Continued)

Monitor items	Display sample on the LED monitor *1	LED indicator ■: ON, □: OFF	Unit	Meaning of displayed value	Function code E43
PID command *3, *4	10.00	□Hz □A □kW	—	PID command/feedback amount transformed to that of virtual physical value of the object to be controlled (e.g. temperature) Refer to function codes E40 and E41 for details.	10
PID feedback amount *3, *5	5.00	□Hz □A □kW	—		12
Timer (Timer operation)*3	50	□Hz □A □kW	min	Remaining time of timer operation	13
PID output *3, *4	100.0	□Hz □A □kW	%	PID output in % as the maximum frequency (F03) being at 100% For motor 2, read F03 as A01.	14
Load factor *6	50	□Hz □A □kW	%	Load factor of the motor in % as the rated output being at 100%	15
Motor output *7	5.85	□Hz □A ■kW	kW	Motor output in kW	16







- \*1 A value exceeding 9999 cannot be displayed on the 4-digit LED monitor screen, so "E 3" appear instead.
- \*2 When the LED monitor displays an output voltage, the 7-segment letter U in the lowest digit stands for the unit of the voltage "V."
- \*3 These PID related items appear only when the inverter PID-controls the motor according to a PID command specified by function code J01 (= 1, 2 or 3).  
The Timer item appears only when the timer operation is enabled with function code C21.  
When the PID control or timer operation is disabled, "----" appear.
- \*4 When the LED monitor displays a PID command or its output amount, the dot (decimal point) attached to the lowest digit of the 7-segment letter blinks.
- \*5 When the LED monitor displays a PID feedback amount, the dot (decimal point) attached to the lowest digit of the 7-segment letter lights.
- \*6 When the LED monitor displays a load factor, the 7-segment letter L in the lowest digit stands for "%."
- \*7 When the LED monitor displays the motor output, the unit LED indicator "kW" blinks.

















### 3.3.2 Setting up frequency and PID commands

You can set up the desired frequency and PID commands by using  and  keys on the keypad. It is also possible to set up the frequency command as load shaft speed, motor speed etc. by setting function code E48.

#### ■ Setting up a frequency command

Using  and  keys (Factory default)

- (1) Set function code F01 to "0:  /  keys on keypad." This can be done only when the inverter is in Running mode.
- (2) Press the  /  key to display the current reference frequency. The lowest digit will blink.
- (3) If you need to change the frequency command, press the  /  key again. The new setting will be automatically saved into the inverter's internal memory and retained even when the power is off. When the power is turned ON next time, the setting will be used as an initial reference frequency.





-  **Tip**
- If you have set function code F01 to "0:  /  keys on keypad" but have selected a frequency command source other than frequency command 1 (i.e., frequency command 2, frequency command via communication, or multi-frequency command), then the  and  keys are disabled to change the current frequency command even in Running mode. Pressing either of these keys just displays the current reference frequency.
  - When you start specifying the reference frequency or any other parameter with the  /  key, the least significant digit on the display blinks; that is, the cursor lies in the least significant digit. Holding down the  /  key changes data in the least significant digit and generates a carry, while the cursor remains in the least significant digit.
  - After the least significant digit blinks by pressing the  /  key, holding down the  key for more than 1 second moves the cursor from the least significant digit to the most significant digit. Further holding it down moves the cursor to the next lower digit. This cursor movement allows you to easily move the cursor to the desired digit and change the data in higher digits.
  - By setting function code C30 to "0:  /  keys on keypad" and selecting frequency command 2, you can also specify or change the frequency command in the same manner using the  /  key.

You can set a reference frequency not only with the frequency (Hz) but also with other menu items (motor speed, load shaft speed, line speed and constant feeding rate time) depending on the setting of function code E48 (= 3, 4, 5 or 6) as listed in Table 3.3.













## ■ Settings under PID process control

To enable the PID process control, you need to set function code J01 to "1" or "2."



Under the PID control, the items that can be specified or checked with  and  keys are different from those under regular frequency control, depending upon the current LED monitor setting. If the LED monitor is set to the speed monitor (E43 = 0), you can access manual speed commands (frequency command) with  and  keys; if it is set to any other, you can access the PID process command with those keys.

 Refer to the FRENIC-Multi User's Manual for the details of the PID control.

### Setting the PID process command with the and keys

- (1) Set function code J02 to "0":  /  keys on keypad."
- (2) Set the LED monitor to something other than the speed monitor (E43=0) when the inverter is in Running mode. When the keypad is in Programming or Alarm mode, you cannot modify the PID process command with the  /  key. To enable the PID process command to be modified with the  /  key, first switch to Running mode.
- (3) Press the  /  key to display the PID process command. The lowest digit of the displayed command and its decimal point blink.
- (4) To change the PID process command, press the  /  key again. The PID process command you have specified will be automatically saved into the inverter's internal memory. It is retained even if you temporarily switch to another PID process command source and then go back to the via-keypad PID process command. Also, it is retained in the memory even while the inverter is powered off, and will be used as the initial PID process command next time the inverter is powered ON.



- Even if multi-frequency is selected as a PID process command (**SS4** or **SS8** = ON), you still can set the process command using the keypad.
- When function code J02 is set to any value other than "0," pressing the  /  key displays, on the 7-segment LED monitor, the PID process command currently selected, while you cannot change the setting.
- On the 7-segment LED monitor, the decimal point of the lowest digit is used to characterize what is displayed. The decimal point of the lowest digit blinks when a PID process command is displayed; the decimal point lights when a PID feedback amount is displayed.

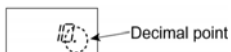



Table 3.4 PID process Command Manually Set with  /  Key and Requirements

PID control (Mode selection) J01	PID control (Remote command <b>SV</b> ) J02	LED monitor E43	Multi-frequency <b>SS4</b> , <b>SS8</b>	With  /  key
1 or 2	0	Other than 0	ON or OFF	PID process command <u>by keypad</u>
	Other than 0			PID process command <u>currently selected</u>

### Setting up the frequency command with $\wedge$ and $\vee$ keys under PID process control

When function code F01 is set to "0" ( $\wedge$ / $\vee$  keys on keypad) and frequency command 1 is selected as a manual speed command (when disabling the frequency setting command via communications link or multi-frequency command), switching the LED monitor to the speed monitor in Running mode enables you to modify the frequency command with the  $\wedge$ / $\vee$  keys.

In Programming or Alarm mode, the  $\wedge$ / $\vee$  keys are disabled to modify the frequency command. You need to switch to Running mode.

Table 3.5 lists the combinations of the commands and the figure illustrates how the manual speed command ① entered via the keypad is translated to the final frequency command ②.

The setting procedure is the same as that for setting of a usual frequency command.

Table 3.5 Manual Speed (Frequency) Command Specified with  $\wedge$ / $\vee$  Keys and Requirements

PID control (Mode selection) J01	LED monitor E43	Frequency command 1 F01	Multi-frequency SS2	Multi-frequency SS1	Communications link operation LE	Cancel PID control Hz/PID	Pressing $\wedge$ / $\vee$ keys controls:	
1 or 2	0	0	OFF	OFF	OFF	OFF (PID enabled)	PID output (as final frequency command)	
						ON (PID disabled)	Manual speed (frequency) command set by keypad	
		Other than the above					OFF (PID enabled)	PID output (as final frequency command)
							ON (PID disabled)	Manual speed (frequency) command currently selected

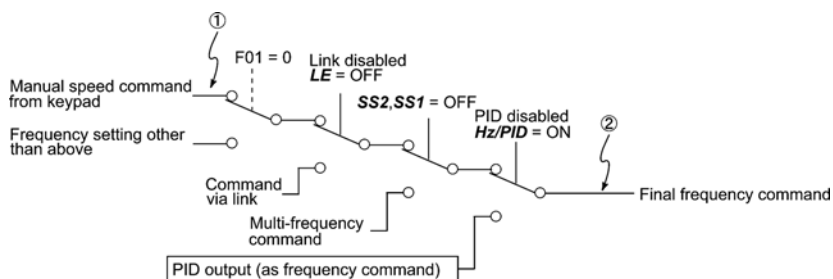

## ■ Settings under PID dancer control

To enable the PID dancer control, you need to set function code J01 to "3."

Under the PID control, the items that can be specified or checked with  $\triangle$  and  $\nabla$  keys are different from those under the regular frequency control, depending upon the current LED monitor setting. If the LED monitor is set to the speed monitor (E43 = 0), the item accessible is the primary frequency command; if it is set to any other data, it is the PID dancer position command.

 Refer to the FRENIC-Multi User's Manual for the details of the PID control.

### Setting the PID dancer position command with the $\triangle$ and $\nabla$ keys

- (1) Set function code J02 to "0:  $\triangle$  /  $\nabla$  keys on keypad."
- (2) Set the LED monitor to something other than the speed monitor (E43=0) when the inverter is in Running mode. When the keypad is in Programming or Alarm mode, you cannot modify the PID command with the  $\triangle$  /  $\nabla$  key. To enable the PID dancer position command to be modified with the  $\triangle$  /  $\nabla$  key, first switch to Running mode.
- (3) Press the  $\triangle$  /  $\nabla$  key to display the PID dancer position command. The lowest digit of the displayed command and its decimal point blink.
- (4) To change the command, press the  $\triangle$  /  $\nabla$  key again. The command you have specified will be automatically saved into the inverter's internal memory as function code J57 data. It is retained even if you temporarily switch to another PID command source and then go back to the via-keypad PID command. Furthermore, you can directly configure the command with function code J57.



- Even if multi-frequency is selected as a PID command (**SS4** or **SS8** = ON), you still can set the PID dancer position command using the keypad.
- When function code J02 is set to any value other than "0," pressing the  $\triangle$  /  $\nabla$  key displays, on the 7-segment LED monitor, the PID command currently selected, while you cannot change the setting.
- On the 7-segment LED monitor, the decimal point of the lowest digit is used to characterize what is displayed. The decimal point of the lowest digit blinks when a PID command is displayed; the decimal point lights when a PID feedback amount is displayed.

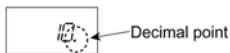

Table 3.6 PID Command Manually Set with  $\triangle$  /  $\nabla$  Key and Requirements

PID control (Mode selection) J01	PID control (Remote command <b>SV</b> ) J02	LED monitor E43	Multi-frequency <b>SS4</b> , <b>SS8</b>	With $\triangle$ / $\nabla$ key
3	0	Other than 0	ON or OFF	PID command <u>by keypad</u>
	Other than 0			PID command <u>currently selected</u>

### Setting up the primary frequency command with $\wedge$ and $\vee$ keys under PID dancer control

When function code F01 is set to "0" ( $\wedge$ / $\vee$  keys on keypad) and frequency command 1 is selected as a primary frequency command (when disabling the frequency setting command via communications link and multi-frequency command), switching the LED monitor to the speed monitor in Running mode enables you to modify the frequency command with the  $\wedge$ / $\vee$  keys.

In Programming or Alarm mode, the  $\wedge$ / $\vee$  keys are disabled to modify the frequency command. You need to switch to Running mode.

Table 3.7 lists the combinations of the commands and the figure illustrates how the primary frequency command ① entered via the keypad is translated to the final frequency command ②.



The setting procedure is the same as that for setting of a usual frequency command.

Table 3.7 Primary Frequency Command Specified with  $\wedge$ / $\vee$  Keys and Requirements

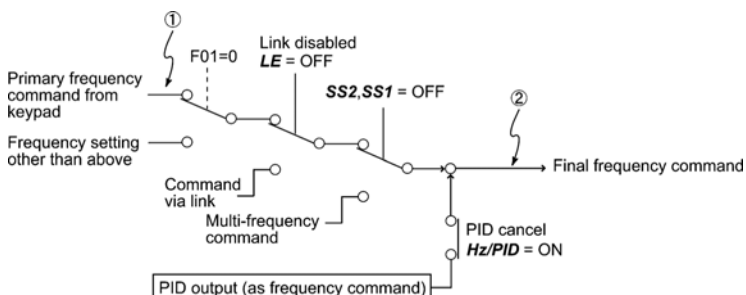
PID control (Mode selection) J01	LED monitor E43	Frequency command 1 F01	Multi-frequency SS2	Multi-frequency SS1	Communications link operation LE	Cancel PID control Hz/PID	Pressing $\wedge$ / $\vee$ keys controls:	
3	0	0	OFF	OFF	OFF	OFF (PID enabled)	Final frequency command modified by PID output	
						ON (PID disabled)	Keypad primary command (Frequency)	
		Other than the above					OFF (PID enabled)	Final frequency command modified by PID output
							ON (PID disabled)	Current primary command (Frequency)



### 3.3.3 Running/stopping the motor

By factory default, pressing the  key starts running the motor in the forward direction and pressing the  key decelerates the motor to stop. The  key is enabled only in Running mode.

The motor rotational direction can be selected by changing the setting of function code F02.



#### ■ Operational relationship between function code F02 (Operation method) and key



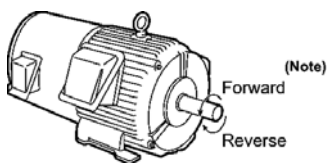

Table 3.8 lists the relationship between function code F02 settings and the  key, which determines the motor rotational direction.

Table 3.8 Motor Rotational Direction Specified by F02

Data for F02	Pressing the  key runs the motor:
0	In the direction commanded by the terminal [FWD] or [REV]
1	 key disabled (The motor is driven by terminal [FWD] or [REV] command.)
2	In the forward direction
3	In the reverse direction



(Note) The rotational direction of IEC-compliant motors is opposite to that of the motor shown here.

 For the details on operations with function code F02, refer to Chapter 5 "FUNCTION CODES."

 When the keypad is in use for specifying the frequency settings or driving the motor, do not disconnect the keypad from the inverter when the motor is running. Doing so may stop the inverter.

## 3.4 Programming Mode

The Programming mode provides you with these functions--setting and checking function code data, monitoring maintenance information and checking input/output (I/O) signal status. The functions can be easily selected with the menu-driven system. Table 3.9 lists menus available in Programming mode. The leftmost digit (numerals) of each letter string on the LED monitor indicates the corresponding menu number and the remaining three digits indicate the menu contents.

When the inverter enters Programming mode from the second time on, the menu selected last in Programming mode will be displayed.

Table 3.9 Menus Available in Programming Mode

Menu #	Menu	LED monitor shows:	Main functions	Refer to:
0	"Quick Setup"	<i>QFC</i>	Displays only basic function codes to customize the inverter operation.	Section 3.4.1
1	"Data Setting"	<i>F--</i>	F codes (Fundamental functions)	Selecting each of these function codes enables its data to be displayed/changed.
		<i>E--</i>	E codes (Extension terminal functions)	
		<i>C--</i>	C codes (Control functions)	
		<i>P--</i>	P codes (Motor 1 parameters)	
		<i>H--</i>	H codes (High performance functions)	
		<i>R--</i>	A codes (Motor 2 parameters)	
		<i>J--</i>	J codes (Application functions)	
		<i>y--</i>	y codes (Link functions)	
		<i>o--</i>	o codes (Optional function)	
2	"Data Checking"	<i>CEP</i>	Displays only function codes that have been changed from their factory defaults. You can refer to or change those function code data.	Section 3.4.3
3	"Drive Monitoring"	<i>DE</i>	Displays the running information required for maintenance or test running.	Section 3.4.4
4	"I/O Checking"	<i>IO</i>	Displays external interface information.	Section 3.4.5
5	"Maintenance Information"	<i>SCHE</i>	Displays maintenance information including cumulative run time.	Section 3.4.6
6	"Alarm Information"	<i>ERL</i>	Displays the recent four alarm codes. You can refer to the running information at the time when the alarm occurred.	Section 3.4.7

**(Note 1)** Mounting an optional multi-function keypad (TP-G1) adds the data copying function to the menu, enabling reading, writing, and verifying of function code data.

**(Note 2)** The o codes are displayed only when the corresponding option is mounted. For details, refer to the Instruction Manual for the corresponding option.



#### ■ Selecting menus to display

The menu-driven system allows you to cycle through menus. To cycle through necessary menus only for simple operation, use function code E52 that provides a choice of three display modes as listed below.

The factory default (E52 = 0) is to display only two menus--Menu #0 "Quick Setup" and Menu #1 "Data Setting," allowing no switching to any other menu.

Table 3.10 Keypad Display Mode Selection – Function Code E52

Data for E52	Mode	Menus selectable
0	Function code data editing mode (factory default)	Menu #0 "Quick Setup" Menu #1 "Data Setting"
1	Function code data check mode	Menu #2 "Data Checking"
2	Full-menu mode	Menus #0 through #6

**Tip** Pressing the  /  key will cycle through the menu. With the  key, you can select the desired menu item. Once the entire menu has been cycled through, the display will return to the first menu item.

### 3.4.1 Setting up basic function codes quickly -- Menu #0 "Quick Setup" --

Menu #0 "Quick Setup" in Programming mode allows you to quickly display and set up a basic set of function codes specified in Chapter 5, Section 5.1, "Function Code Tables."

To use Menu #0 "Quick Setup," you need to set function code E52 to "0" (Function code data editing mode) or "2" (Full-menu mode).

The predefined set of function codes that are subject to quick setup are held in the inverter.

Listed below are the function codes (including those not subject to quick setup) available on the FRENIC-Multi.

Table 3.11 Function Codes Available on FRENIC-Multi

Function code group	Function codes	Function	Description
F codes	F00 to F51	Fundamental functions	Functions concerning basic motor running
E codes	E01 to E99	Extension terminal functions	Functions concerning the assignment of control circuit terminals Functions concerning the display of the LED monitor
C codes	C01 to C53	Control functions	Functions associated with frequency settings
P codes	P01 to P99	Motor 1 parameters	Functions for setting up characteristics parameters (such as capacity) of the motor
H codes	H03 to H98	High performance functions	Highly added-value functions Functions for sophisticated control
A codes	A01 to A46	Motor 2 parameters	Functions for setting up characteristics parameters (such as capacity) of the motor
J codes	J01 to J92	Application functions	Functions for applications such as PID control
y codes	y01 to y99	Link functions	Functions for controlling communication
o codes	o01 to o59	Optional functions	Functions for options ( <b>Note</b> )

(**Note**) The o codes are displayed only when the corresponding option is mounted. For details of the o codes, refer to the Instruction Manual for the corresponding option.

 For the list of function codes subject to quick setup and their descriptions, refer to Chapter 5, Section 5.1 "Function Code Tables."

 Through a multi-function keypad, you can add or delete function codes that are subject to Quick Setup. For details, refer to the "Multi-function Keypad Instruction Manual."

Once you have added or deleted function codes for Quick Setup through a multi-function keypad, they will remain valid even after you switch to a standard keypad. To restore the function code settings subject to Quick Setup to their factory defaults, initialize the whole data using function code H03 (data = 1).

Figure 3.2 shows the menu transition in Menu #0 "Quick Setup."

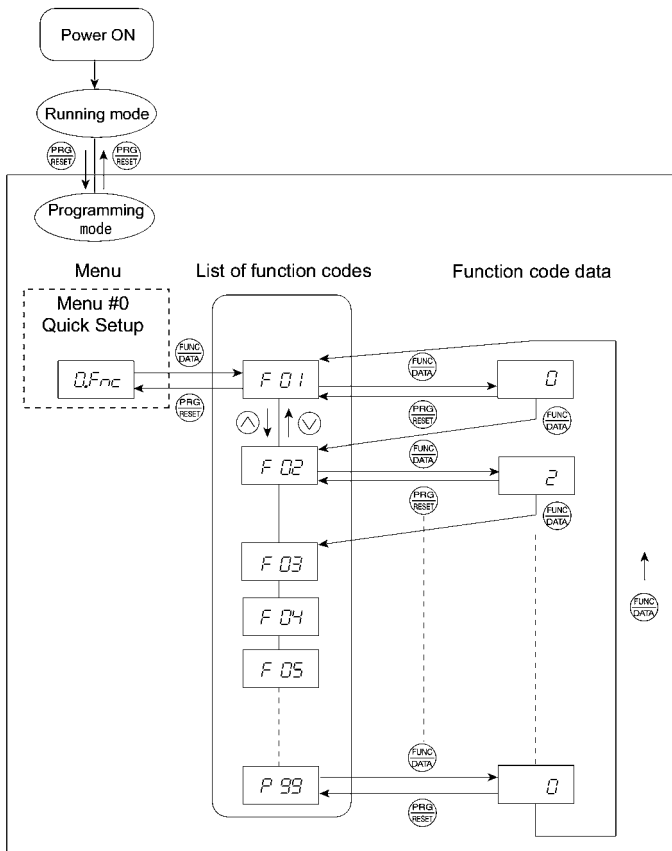

Figure 3.2 Menu Transition in Menu #0 "Quick Setup"

### Basic key operation

This section gives a description of the basic key operation, following the example of the function code data changing procedure shown in Figure 3.3.

This example shows you how to change function code F01 data from the factory default "∧/∨" keys on keypad (F01 = 0) to "Current input to terminal [C1] (C1 function) (4 to 20 mA DC) (F01 = 2)."

- (1) Turn the inverter ON. It automatically enters Running mode. In that mode, press the key to switch to Programming mode. The function selection menu appears. (In this example, *Func* is displayed.)
- (2) If anything other than *Func* is displayed, use the and keys to display *Func*.
- (3) Press the key to proceed to a list of function codes.
- (4) Use the and keys to display the desired function code (*F 01* in this example), then press the key.  
The data of this function code appears. (In this example, data *0* of *F 01* appears.)



- (5) Change the function code data using the  $\wedge$  and  $\vee$  keys. (In this example, press the  $\wedge$  key two times to change data 0 to 2.)
- (6) Press the  $\text{FUNC DATA}$  key to establish the function code data.  
 The *SAVE* appears and the data will be saved in the memory inside the inverter. The display will return to the function code list, then move to the next function code. (In this example, *F 02*.)  
 Pressing the  $\text{FUNC RESET}$  key instead of the  $\text{FUNC DATA}$  key cancels the change made to the data. The data reverts to the previous value, the display returns to the function code list, and the original function code reappears.
- (7) Press the  $\text{FUNC RESET}$  key to return to the menu from the function code list.



### Cursor movement

You can move the cursor when changing function code data by holding down the  $\text{FUNC DATA}$  key for 1 second or longer in the same way as with the frequency settings. This action is called "Cursor movement."

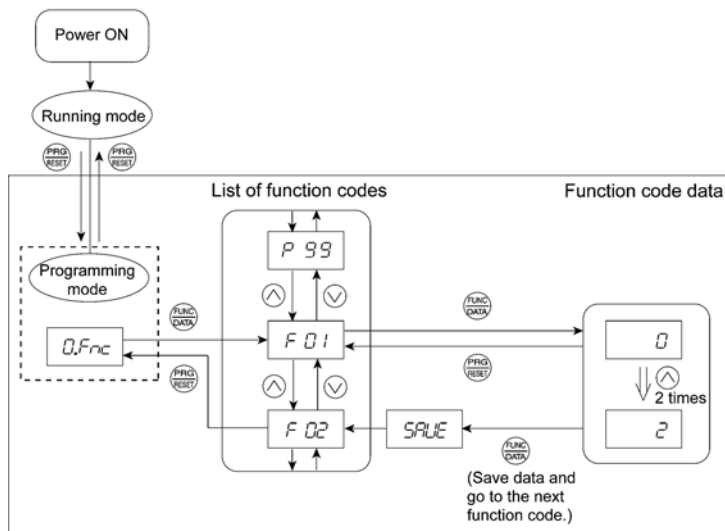

Figure 3.3 Example of Function Code Data Changing Procedure

### 3.4.2 Setting up function codes -- Menu #1 "Data Setting" --

Menu #1 "Data Setting" in Programming mode allows you to set up function codes for making the inverter functions match your needs.

To set function codes in this menu, it is necessary to set function code E52 to "0" (Function code data editing mode) or "2" (Full-menu mode).

#### Basic key operation

For details of the basic key operation, refer to Menu #0 "Quick Setup" in Section 3.4.1.

### 3.4.3 Checking changed function codes -- Menu #2 "Data Checking" --

Menu #2 "Data Checking" in Programming mode allows you to check function codes that have been changed. Only the function codes whose data has been changed from the factory defaults are displayed on the LED monitor. You can refer to the function code data and change it again if necessary. The menu transition in Menu #2 "Data Checking" is as same as its of Menu #0 "Quick Setup."

#### Basic key operation

For details of the basic key operation, refer to Menu #0 "Quick Setup" in Section 3.4.1.

**Tip** To check function codes in Menu #2 "Data Checking," it is necessary to set function code E52 to "1" (Function code data check mode) or "2" (Full-menu mode).

### 3.4.4 Monitoring the running status -- Menu #3 "Drive Monitoring" --

Menu #3 "Drive Monitoring" is used to monitor the running status during maintenance and trial running. The display items for "Drive Monitoring" are listed in Table 3.12. Figure 3.4 shows the menu transition in Menu #3 "Drive Monitoring."

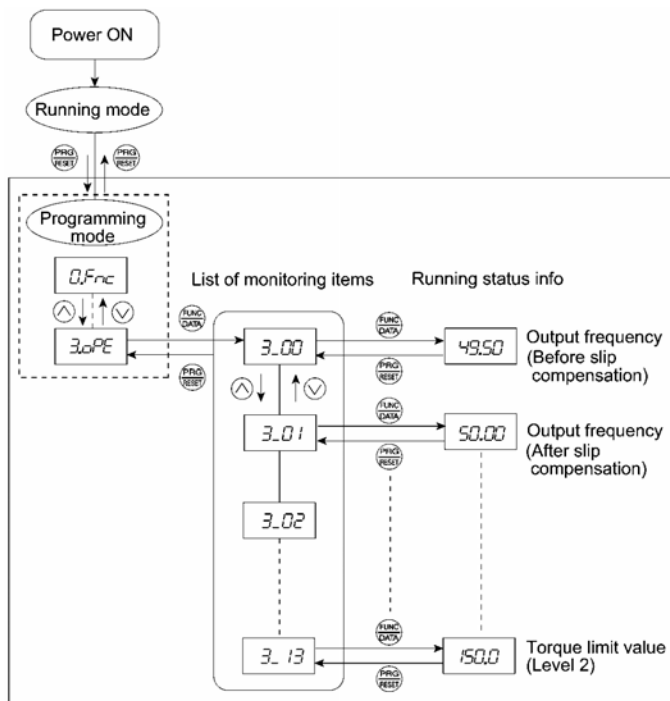

Figure 3.4 Menu Transition in Menu #3 "Drive Monitoring"

## Basic key operation

To monitor the running status on the drive monitor, set function code E52 to "2" (Full-menu mode) beforehand.











- Turn the inverter ON. It automatically enters Running mode. In that mode, press the  key to switch to Programming mode. The function selection menu appears.
- Use the  and  keys to display "Drive Monitoring" (3.0PE).
- Press the  key to proceed to a list of monitoring items (e.g. 3.00).
- Use the  and  keys to display the desired monitoring item, then press the  key. The running status information for the selected item appears.
- Press the  key to return to a list of monitoring items. Press the  key again to return to the menu.

Table 3.12 Drive Monitor Display Items

LED monitor shows:	Item	Unit	Description
3.00	Output frequency	Hz	Output frequency before slip compensation
3.01	Output frequency	Hz	Output frequency after slip compensation
3.02	Output current	A	Output current
3.03	Output voltage	V	Output voltage
3.04	Calculated torque	%	Calculated output torque of the motor in %
3.05	Reference frequency	Hz	Frequency specified by a frequency command
3.06	Rotational direction	N/A	Rotational direction being outputted F: forward, r: reverse, ----: stop
3.07	Running status	N/A	Running status in hexadecimal format Refer to "■ Displaying running status" on the next page.
3.08	Motor speed	r/min	Display value = (Output frequency Hz) × $\frac{120}{(\text{Function code P01})}$ For motor 2, read P01 as A15.
3.09	Load shaft speed or Line speed	r/min m/min	Display value = (Output frequency Hz) × (Function code E50) The 7-segment letters  appear for 10000 (r/min) or more. If  appear, decrease function code E50 data so that the LED monitor displays 9999 or below, referring to the above equation.
3.10	PID command	N/A	Virtual physical value (e.g., temperature or pressure) of the object to be controlled, which is converted from the PID command using function code E40 and E41 data (PID display coefficients A and B) Display value = (PID command) × (Coefficient A - B) + B If PID control is disabled, "----" appears.
3.11	PID feedback amount	N/A	Virtual physical value (e.g., temperature or pressure) of the object to be controlled, which is converted from the PID command using function code E40 and E41 data (PID display coefficients A and B) Display value = (PID feedback amount) × (Coefficient A - B) + B If PID control is disabled, "----" appears.
3.12	Torque limit value	%	Driving torque limit value A (based on motor rated torque)
3.13	Torque limit value	%	Braking torque limit value B (based on motor rated torque)

### ■ Displaying running status

To display the running status in hexadecimal format, each state has been assigned to bits 0 to 15 as listed in Table 3.13. Table 3.14 shows the relationship between each of the status assignments and the LED monitor display. Table 3.15 gives the conversion table from 4-bit binary to hexadecimal.

Table 3.13 Running Status Bit Assignment

Bit	Notation	Content	Bit	Notation	Content
15	BUSY	"1" when function code data is being written.	7	VL	"1" under voltage limiting control.
14	WR	Always "0."	6	TL	"1" under torque limiting control.
13		Always "0."	5	NUV	"1" when the DC link bus voltage is higher than the undervoltage level.
12	RL	"1" when communication is enabled (when ready for run and frequency commands via communications link).	4	BRK	"1" during braking.
11	ALM	"1" when an alarm has occurred.	3	INT	"1" when the inverter output is shut down.
10	DEC	"1" during deceleration.	2	EXT	"1" during DC braking.
9	ACC	"1" during acceleration.	1	REV	"1" during running in the reverse direction.
8	IL	"1" under current limiting control.	0	FWD	"1" during running in the forward direction.

Table 3.14 Running Status Display

LED No.	LED4				LED3				LED2				LED1												
Bit	15	14	13	12	11	10	9	8	7	6	5	4	3	2	1	0									
Notation	BUSY	WR	RL	ALM	DEC	ACC	IL	VL	TL	NUV	BRK	INT	EXT	REV	FWD										
Example	Binary	1	0	0	0	0	0	1	1	0	0	1	0	0	0	0	1								
	Hexadecimal on the LED monitor	<table style="margin: auto; border-collapse: collapse;"> <thead> <tr> <th style="border: none;"></th> <th style="border: none;">LED4</th> <th style="border: none;">LED3</th> <th style="border: none;">LED2</th> <th style="border: none;">LED1</th> </tr> </thead> <tbody> <tr> <td style="border: none; text-align: center;">8</td> <td style="border: none; text-align: center;">3</td> <td style="border: none; text-align: center;">2</td> <td style="border: none; text-align: center;">1</td> <td style="border: none;"></td> </tr> </tbody> </table>																LED4	LED3	LED2	LED1	8	3	2	1
	LED4	LED3	LED2	LED1																					
8	3	2	1																						

### ■ Hexadecimal expression

A 4-bit binary number can be expressed in hexadecimal format (1 hexadecimal digit). Table 3.15 shows the correspondence between the two notations. The hexadecimals are shown as they appear on the LED monitor.

Table 3.15 Binary and Hexadecimal Conversion

Binary				Hexadecimal	Binary				Hexadecimal
0	0	0	0	0	1	0	0	0	8
0	0	0	1	1	1	0	0	1	9
0	0	1	0	2	1	0	1	0	A
0	0	1	1	3	1	0	1	1	B
0	1	0	0	4	1	1	0	0	C
0	1	0	1	5	1	1	0	1	D
0	1	1	0	6	1	1	1	0	E
0	1	1	1	7	1	1	1	1	F

### 3.4.5 Checking I/O signal status -- Menu #4 "I/O Checking" --

Using Menu #4 "I/O Checking" displays the I/O status of external signals including digital and analog I/O signals without using a measuring instrument. Table 3.16 lists check items available. The menu transition in Menu #4 "I/O Checking" is shown in Figure 3.5.

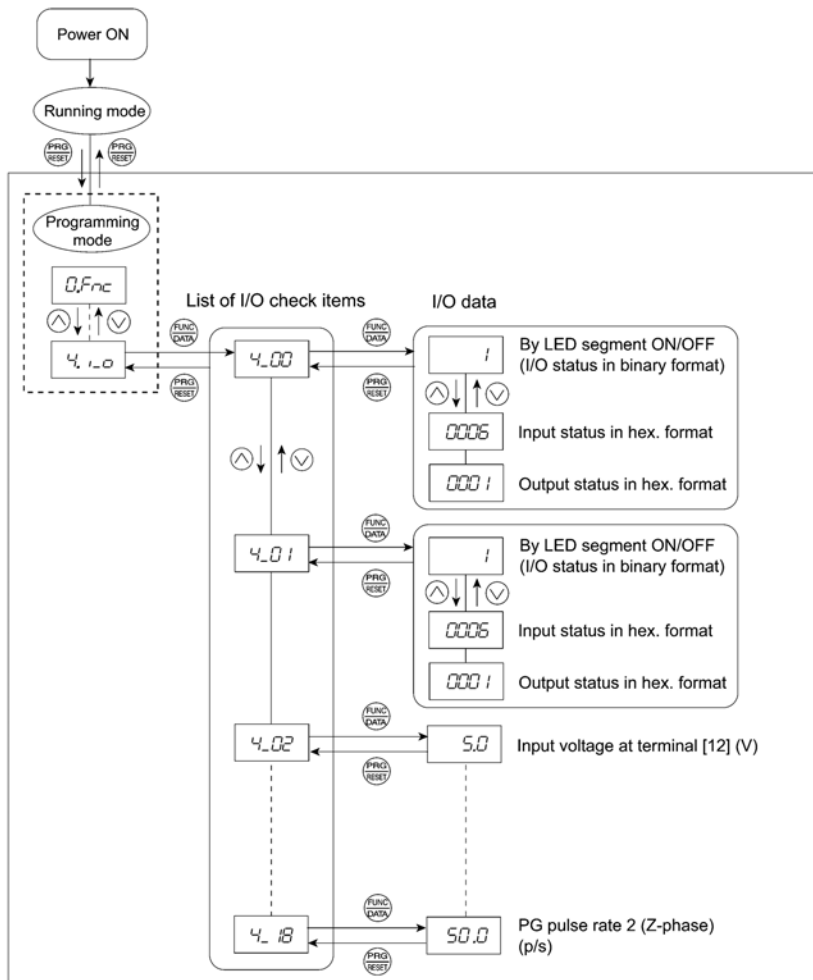

Figure 3.5 Menu Transition in Menu #4 "I/O Checking"

## Basic key operation

To check the status of the I/O signals, set function code E52 to "2" (Full-menu mode) beforehand.











- (1) Turn the inverter ON. It automatically enters Running mode. In that mode, press the  key to switch to Programming mode. The function selection menu appears.
- (2) Use the  and  keys to display "I/O Checking" (4\_1\_0).
- (3) Press the  key to proceed to a list of I/O check items (e.g. 4\_00).
- (4) Use the  and  keys to display the desired I/O check item, then press the  key.  
The corresponding I/O check data appears. For the item 4\_00 or 4\_01, using the  and  keys switches the display method between the segment display (for external signal information in Table 3.17) and hexadecimal display (for I/O signal display in Table 3.18).
- (5) Press the  key to return to a list of I/O check items. Press the  key again to return to the menu.

Table 3.16 I/O Check Items

LED monitor shows:	Item	Description
4_00	I/O signals on the control circuit terminals	Shows the ON/OFF state of the digital I/O terminals. Refer to " <a href="#">■ Displaying control I/O signal terminals</a> " on the next page for details.
4_01	I/O signals on the control circuit terminals under communications control	Shows the ON/OFF state of the digital I/O terminals that received a command via RS-485 and optional communications. Refer to " <a href="#">■ Displaying control I/O signal terminals</a> " and " <a href="#">■ Displaying control I/O signal terminals under communications control</a> " on the following pages for details.
4_02	Input voltage on terminal [12]	Shows the input voltage on terminal [12] in volts (V).
4_03	Input current on terminal [C1]	Shows the input current on terminal [C1] in milliamperes (mA).
4_04	Output voltage to analog meters [FM]	Shows the output voltage on terminal [FM] in volts (V).
4_05	Pulse rate of [FM]	Shows the output pulse rate on terminal [FM] in pulses per second (p/s).
4_07	Input voltage on terminal [C1]	Shows the input voltage on terminal [C1] (V2 function assigned) in volts (V).
4_10	Option control circuit terminal (I/O)	Shows the ON/OFF state of the digital I/O terminals on the digital I/O interface option. Refer to " <a href="#">■ Displaying control I/O signal terminals on digital I/O interface option</a> " on page 3-22 for details.
4_15	PG pulse rate 1 (A/B phase)	Shows the PG pulse rate inputted when the PG interface is installed. Displayed value = Pulse rate (p/s) ÷ 1000
4_16	PG pulse rate 1 (Z phase)	Shows the pulse rate (p/s) in Z phase when the PG interface is installed.
4_17	PG pulse rate 2 (A/B phase)	Shows the second PG pulse rate inputted when two PG interfaces are installed. Displayed value = Pulse rate (p/s) ÷ 1000
4_18	PG pulse rate 2 (Z phase)	Shows the second PG pulse rate (p/s) in Z phase when two PG interfaces are installed.

### ■ Displaying control I/O signal terminals

The status of control I/O signal terminals may be displayed with ON/OFF of the LED segment or in hexadecimal display.

- Display I/O signal status with ON/OFF of each LED segment

As shown in Table 3.17 and the figure below, each of segments "a" to "g" on LED1 lights when the corresponding digital input terminal circuit ([FWD], [REV], [X1], [X2], [X3], [X4] or [X5]) is closed; it goes off when it is open. Segment "a" and "b" on LED3 light when the circuit between output terminal [Y1] or [Y2] and terminal [CMY], and do not light when the circuit is open. Segment "a" on LED4 is for terminals [30A/B/C]. Segment "a" on LED4 lights when the circuit between terminals [30C] and [30A] is short-circuited (ON) and does not light when it is open.

**Tip** If all terminal input signals are OFF (open), segment "g" on all of LED1 to LED4 will light ("----").

Table 3.17 Segment Display for External Signal Information

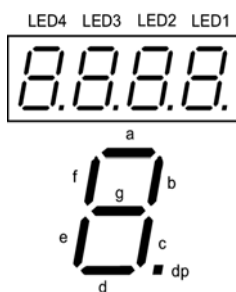

Segment	LED4	LED3	LED2	LED1
a	30A/B/C	Y1-CMY	—	FWD
b	—	Y2-CMY	—	REV
c	—	—	—	X1
d	—	—	—	X2
e	—	—	—	X3
f	—	—	(XF)*	X4
g	—	—	(XR)*	X5
dp	—	—	(RST)*	—

—: No corresponding control circuit terminal exists

\* (XF), (XR), and (RST) are assigned for communication. Refer to "■ Displaying control I/O signal terminals under communications control" on the next page.

- Displaying I/O signal status in hexadecimal format

Each I/O terminal is assigned to bit 15 through bit 0 as shown in Table 3.18. An unassigned bit is interpreted as "0." Allocated bit data is displayed on the LED monitor as four hexadecimal digits (each).

With the FRENIC-Multi, digital input terminals [FWD] and [REV] are assigned to bit 0 and bit 1, respectively. Terminals [X1] through [X5] are assigned to bits 2 through 6. The bit is set to "1" when the corresponding input terminal is short-circuited (ON), and is set to "0" when it is open (OFF). For example, when [FWD] and [X1] are ON (short-circuited) and all the others are OFF (open), 0005 is displayed on LED4 to LED1.

Digital output terminal [Y1] and [Y2] are assigned to bits 0 and 1. Each bit is set to "1" when the terminal is short-circuited with [CMY], and "0" when it is open.

The status of the relay contact output terminal [30A/B/C] is assigned to bit 8. It is set to "1" when the circuit between output terminals [30A] and [30C] is closed, and "0" when the circuit between [30A] and [30C] is open.

For example, if [Y1] is ON, [Y2] is OFF, and the circuit between [30A] and [30C] is closed, then "0011" is displayed on the LED4 to LED1.

Table 3.18 presents an example of bit assignment and corresponding hexadecimal display on the 7-segment LED.

Table 3.18 Segment Display for I/O Signal Status in Hexadecimal Format

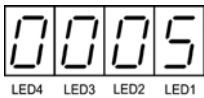
LED No.		LED4				LED3				LED2				LED1			
Bit		15	14	13	12	11	10	9	8	7	6	5	4	3	2	1	0
Input terminal		(RST)*	(XR)*	(XF)*	-	-	-	-	-	-	X5	X4	X3	X2	X1	REV	FWD
Output terminal		-	-	-	-	-	-	-	30 A/B/C	-	-	-	-	-	-	Y2	Y1
Example	Binary	0	0	0	0	0	0	0	0	0	0	0	0	0	1	0	1
	Hexadecimal on the LED monitor																

– No corresponding control circuit terminal exists.

\* (XF), (XR), and (RST) are assigned for communication. Refer to **"■ Displaying control I/O signal terminals under communications control"** below.

#### ■ Displaying control I/O signal terminals under communications control

Under communications control, input commands (function code S06) sent via RS-485 or other optional communications can be displayed in two ways: "with ON/OFF of each LED segment" and "in hexadecimal format." The content to be displayed is basically the same as that for the control I/O signal terminal status display; however, (XF), (XR), and (RST) are added as inputs. Note that under communications control, the I/O display is in normal logic (using the original signals not inverted).

📖 Refer to the RS-485 Communication User's Manual for details on input commands sent through RS-485 communications and the instruction manual of communication-related options as well.

#### ■ Displaying control I/O signal terminals on digital I/O interface option

The LED monitor can also show the signal status of the terminals on the digital I/O interface option, just like the control circuit terminals.

Table 3.19 lists the assignment between LED segments and I/O signals.

Table 3.19 Segment Display for External Signal Information



Segment	LED4	LED3	LED2	LED1
a	—	O1	I9	I1
b	—	O2	I10	I2
c	—	O3	I11	I3
d	—	O4	I12	I4
e	—	O5	SEL	I5
f	—	O6	—	I6
g	—	O7	—	I7
dp	—	O8	—	I8

LED No.		LED4				LED3				LED2				LED1			
Bit		15	14	13	12	11	10	9	8	7	6	5	4	3	2	1	0
Input terminal		-	-	-	SEL	I12	I11	I10	I9	I8	I7	I6	I5	I4	I3	I2	I1
Output terminal		-	-	-	-	-	-	-	-	O8	O7	O6	O5	O4	O3	O2	O1



### 3.4.6 Reading maintenance information -- Menu #5 "Maintenance Information" --

Menu #5 "Maintenance Information" contains information necessary for performing maintenance on the inverter. The menu transition in Menu #5 "Maintenance information" is as same as its of in Menu #3 "Drive Monitoring."

#### Basic key operation

To view the maintenance information, set function code E52 to "2" (Full-menu mode) beforehand.









- (1) Turn the inverter ON. It automatically enters Running mode. In that mode, press the  key to switch to Programming mode. The function selection menu appears.
- (2) Use the  and  keys to display "Maintenance Information" (S.L.H.E.).
- (3) Press the  key to proceed to a list of maintenance item codes (e.g. 5.00).
- (4) Use the  and  keys to display the desired maintenance item, then press the  key. The data of the corresponding maintenance item appears.
- (5) Press the  key to return to a list of maintenance items. Press the  key again to return to the menu.

Table 3.20 Display Items for Maintenance Information

LED Monitor shows:	Item	Description
5_00	Cumulative run time	Shows the content of the cumulative power-ON time counter of the inverter. Unit: thousands of hours. (Display range: 0.001 to 9.999, 10.00 to 65.53) When the total ON-time is less than 10000 hours (display: 0.001 to 9.999), data is shown in units of one hour (0.001). When the total time is 10000 hours or more (display: 10.00 to 65.53), it is shown in units of 10 hours (0.01). When the total time exceeds 65535 hours, the counter will be reset to 0 and the count will start again.
5_01	DC link bus voltage	Shows the DC link bus voltage of the inverter main circuit. Unit: V (volts)
5_03	Max. temperature of heat sink	Shows the maximum temperature of the heat sink for every hour. Unit: °C (Temperatures below 20°C are displayed as 20°C.)
5_04	Max. effective output current	Shows the maximum current in RMS for every hour. Unit: A (amperes)
5_05	Capacitance of the DC link bus capacitor	Shows the current capacitance of the DC link bus capacitor (reservoir capacitor) in %, based on the capacitance when shipping as 100%. Refer to Chapter 7 "MAINTENANCE AND INSPECTION" for details. Unit: %
5_06	Cumulative run time of electrolytic capacitors on the printed circuit boards	Shows the content of the cumulative run time counter of the electrolytic capacitors mounted on the printed circuit boards. Unit: thousands of hours. (Display range: 0.001 to 99.99) Shown in units of 10 hours. When the total time exceeds 99990 hours, the count stops and the display remains at 99.99.
5_07	Cumulative run time of the cooling fan	Shows the content of the cumulative run time counter of the cooling fan. This counter does not work when the cooling fan ON/OFF control (function code H06) is enabled and the fan is stopped. Unit: thousands of hours. (Display range: 0.001 to 99.99) Shown in units of 10 hours. When the total time exceeds 99990 hours, the count stops and the display remains at 99.99.

Table 3.20 Display Items for Maintenance Information (Continued)

LED Monitor shows:	Item	Description
5_08	Number of startups	Shows the content of the cumulative counter of times the inverter is started up (i.e., the number of run commands issued). 1.000 indicates 1000 times. When any number from 0.001 to 9.999 is displayed, the counter increases by 0.001 per startup, and when any number from 10.00 to 65.53 is counted, the counter increases by 0.01 every 10 startups. When the counted number exceeds 65535, the counter will be reset to 0 and the count will start again.
5_09	Input watt-hour	Shows the input watt-hour of the inverter. Unit: 100 kWh (Display range: 0.001 to 9999) Depending on the value of integrated input watt-hour, the decimal point on the LED monitor shifts to show it within the LED monitor's resolution (e.g. the resolution varies between 0.001, 0.01, 0.1 or 1). To reset the integrated input watt-hour and its data, set function code E51 to "0.000." When the input watt-hour exceeds 1000000 kWh, it returns to "0."
5_10	Input watt-hour data	Shows the value expressed by "input watt-hour (kWh) × E51 (whose data range is 0.000 to 9999)." Unit: None. (Display range: 0.001 to 9999. The data cannot exceed 9999. (It will be fixed at 9999 once the calculated value exceeds 9999.)) Depending on the value of integrated input watt-hour data, the decimal point on the LED monitor shifts to show it within the LED monitors' resolution. To reset the integrated input watt-hour data, set function code E51 to "0.000."
5_11	Number of RS-485 errors (standard)	Shows the total number of errors that have occurred in <i>standard</i> RS-485 communication (via the RJ-45 connector as standard) since the power is turned ON. Once the number of errors exceeds 9999, the count returns to 0.
5_12	Content of RS-485 communication error (standard)	Shows the most recent error that has occurred in <i>standard</i> RS-485 communication in decimal format. For error contents, refer to the RS-485 Communication User's Manual.
5_13	Number of option errors	Shows the total number of optional communications card errors since the power is turned ON. Once the number of errors exceeds 9999, the count returns to 0.
5_14	Inverter's ROM version	Shows the inverter's ROM version as a 4-digit code.
5_15	Keypad's ROM version	Shows the keypad's ROM version as a 4-digit code.
5_17	Number of RS-485 errors (option)	Shows the total number of errors that have occurred in <i>optional</i> RS-485 communication since the power is turned ON. Once the number of errors exceeds 9999, the count returns to 0.
5_18	Content of RS-485 communication error (option)	Shows the most recent error that has occurred in <i>optional</i> RS-485 communication in decimal format. For error contents, refer to the RS-485 Communication User's Manual.
5_19	Option's ROM version	Shows the option's ROM version as a 4-digit code.
5_23	Cumulative motor run time	Shows the content of the cumulative power-ON time counter of the motor. The display method is the same as for "Cumulative run time" (5_00) above.

### 3.4.7 Reading alarm information -- Menu #6 "Alarm Information" --

Menu #6 "Alarm Information" shows the causes of the past 4 alarms in alarm code. Further, it is also possible to display alarm information that indicates the status of the inverter when the alarm occurred. Figure 3.6 shows the menu transition in Menu #6 "Alarm Information" and Table 3.21 lists the details of the alarm information.

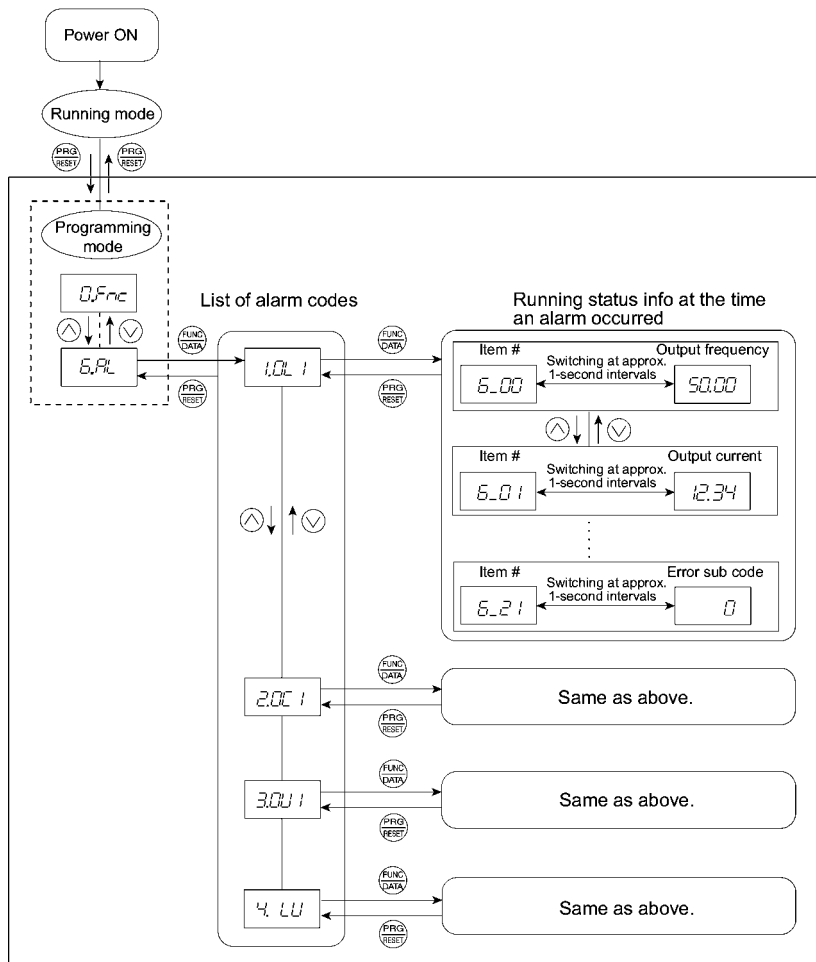

Figure 3.6 "Alarm Information" Menu Transition

## Basic key operation

To view the alarm information, set function code E52 to "2" (Full-menu mode) beforehand.











- Turn the inverter ON. It automatically enters Running mode. In that mode, press the  key to switch to Programming mode. The function selection menu appears.
- Use the  and  keys to display "Alarm Information" (E<sub>5</sub>FL).
- Press the  key to proceed to a list of alarm codes (e.g. 1.0L 1).  
In the list of alarm codes, the alarm information for the last 4 alarms is saved as an alarm history.
- Each time the  or  key is pressed, the last 4 alarms are displayed in order from the most recent one as 1, 2, 3, and 4.
- While the alarm code is displayed, press the  key to have the corresponding alarm item number (e.g. 5.00) and data (e.g. Output frequency) displayed alternately in intervals of approximately 1 second. You can also have the item number (e.g. 5.01) and data (e.g. Output current) for any other item displayed using the  and  keys.
- Press the  key to return to a list of alarm codes. Press the  key again to return to the menu.

Table 3.21 Alarm Information Displayed

LED monitor shows: (item No.)	Item displayed	Description
5.00	Output frequency	Output frequency
5.01	Output current	Output current
5.02	Output voltage	Output voltage
5.03	Calculated torque	Calculated motor output torque
5.04	Reference frequency	Frequency specified by frequency command
5.05	Rotational direction	This shows the rotational direction being output. F: forward, r: reverse, ---: stop
5.06	Running status	This shows the running status in hexadecimal. Refer to "■ Displaying running status" in Section 3.4.4.
5.07	Cumulative run time	Shows the content of the cumulative power-ON time counter of the inverter. Unit: thousands of hours. (Display range: 0.001 to 9.999, 10.00 to 65.53) When the total ON-time is less than 10000 hours (display: 0.001 to 9.999), data is shown in units of one hour (0.001). When the total time is 10000 hours or more (display: 10.00 to 65.53), it is shown in units of 10 hours (0.01). When the total time exceeds 65535 hours, the counter will be reset to 0 and the count will start again.
5.08	No. of startups	Shows the content of the cumulative counter of times the inverter is started up (i.e., the number of run commands issued). 1.000 indicates 1000 times. When any number from 0.001 to 9.999 is displayed, the counter increases by 0.001 per startup, and when any number from 10.00 to 65.53 is counted, the counter increases by 0.01 every 10 startups. When the counted number exceeds 65535, the counter will be reset to 0 and the count will start again.
5.09	DC link bus voltage	Shows the DC link bus voltage of the inverter main circuit. Unit: V (volts)

Table 3.21 Alarm Information Displayed (Continued)

LED monitor shows: (item No.)	Item displayed	Description
5_11	Max. temperature of heat sink	Shows the temperature of the heat sink. Unit: °C
5_12	Terminal I/O signal status (displayed with the ON/OFF of LED segments)	Shows the ON/OFF status of the digital I/O terminals. Refer to "■ <u>Displaying control I/O signal terminals</u> " in Section 3.4.5 "Checking I/O signal status" for details.
5_13	Terminal input signal status (in hexadecimal format)	
5_14	Terminal output signal status (in hexadecimal format)	
5_15	No. of consecutive occurrences	This is the number of times the same alarm occurs consecutively.
5_16	Multiple alarm 1	Simultaneously occurring alarm codes (1) ("----" is displayed if no alarms have occurred.)
5_17	Multiple alarm 2	Simultaneously occurring alarm codes (2) ("----" is displayed if no alarms have occurred.)
5_18	Terminal I/O signal status under communications control (displayed with the ON/OFF of LED segments)	Shows the ON/OFF status of the digital I/O terminals under RS-485 communications control. Refer to "■ <u>Displaying control I/O signal terminals under communications control</u> " in Section 3.4.5 "Checking I/O signal status" for details.
5_19	Terminal input signal status under communications control (in hexadecimal format)	
5_20	Terminal output signal status under communications control (in hexadecimal format)	
5_21	Error sub code	Secondary error code for the alarm.



When the same alarm occurs repeatedly in succession, the alarm information for the first occurrences will be preserved and the information for other occurrences in-between will be discarded. The number of consecutive occurrences will be preserved as the first alarm information.

### 3.5 Alarm Mode

If an abnormal condition arises, the protective function is invoked and issues an alarm, then the inverter automatically enters Alarm mode. At the same time, an alarm code appears on the LED monitor.

#### ■ Releasing the alarm and switching to Running mode

Remove the cause of the alarm and press the key to release the alarm and return to Running mode. The alarm can be removed using the key only when the latest alarm code is displayed.

#### ■ Displaying the alarm history

It is possible to display the most recent 3 alarm codes in addition to the one currently displayed. Previous alarm codes can be displayed by pressing the / key while the current alarm code is displayed.

### ■ Displaying the status of inverter at the time of alarm

When the alarm code is displayed, you may check various running status information (output frequency and output current, etc.) by pressing the key. The item number and data for each running information will be displayed alternately.

Further, you can view various pieces of information on the running status of the inverter using the / key. The information displayed is the same as for Menu #6 "Alarm Information" in Programming mode. Refer to Table 3.21 in Section 3.4.7, "Reading alarm information."

Pressing the key while the running status information is displayed returns the display to the alarm codes.

**Note** When the running status information is displayed after removal of the alarm cause, pressing the key twice returns to the alarm code display and releases the inverter from the alarm state. This means that the motor starts running if a run command has been received by this time.

### ■ Switching to Programming mode

You can also switch to Programming mode by pressing + keys simultaneously with the alarm displayed, and modify the function code data.

Figure 3.7 summarizes the possible transitions between different menu items.

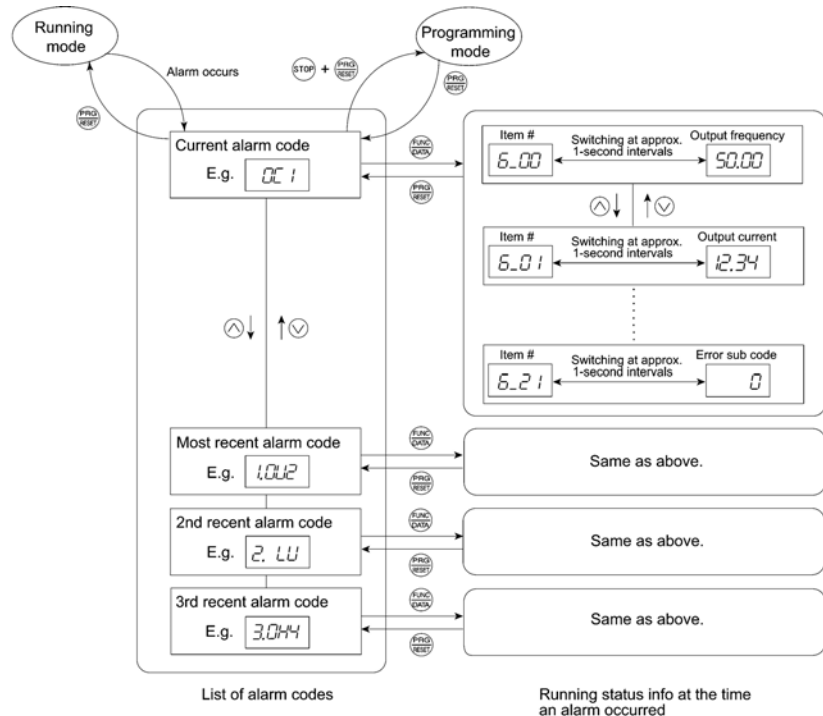

Figure 3.7 Menu Transition in Alarm Mode

## Chapter 4 RUNNING THE MOTOR

### 4.1 Running the Motor for a Test

#### 4.1.1 Inspection and preparation prior to powering on

Check the following prior to powering on.

- (1) Check if connection is correct.

Especially check if the power wires are connected to the inverter input terminals L1/R, L2/S and L3/T or L1/L and L2/N, and output terminals U, V and W respectively and that the grounding wires are connected to the ground electrodes correctly. Refer to Figure 4.1.

### ⚠ WARNING

- Do not connect power supply wires to the inverter output terminals U, V, and W. Otherwise, the inverter may be broken if you turn the power ON.
- Be sure to connect the grounding wires of the inverter and the motor to the ground electrodes. **Otherwise, electric shock may occur.**

- (2) Check for short circuits between terminals and exposed live parts and ground faults.
- (3) Check for loose terminals, connectors and screws.
- (4) Check if the motor is separated from mechanical equipment.
- (5) Turn the switches OFF so that the inverter does not start or operate erroneously at power-on.
- (6) Check if safety measures are taken against runaway of the system, e.g., a defense to protect people from unexpectedly approaching your power system.

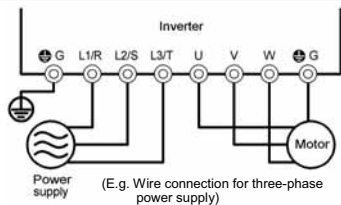

Figure 4.1 Connection of Main Circuit Terminals



#### 4.1.2 Turning ON power and checking

### ⚠ WARNING

- Be sure to install the terminal cover if any before turning the power ON. Do not remove any cover while powering on.
- Do not operate switches with wet hands. **Otherwise electric shock could occur.**

Turn the power ON and check the following points. This is a case when no function code data is changed from the factory setting.

- (1) Check if the LED monitor displays *0.00* (means that the frequency command is 0 Hz) that is blinking. (See Figure 4.2.)

If the LED monitor displays numbers except *0.00*, press  /  keys to set *0.00* as the frequency command.

- (2) Check if a built-in cooling fan rotates. (For the inverter of 1 HP or below, no cooling fan is mounted.)



Figure 4.2 Display of the LED Monitor after Power-on

### 4.1.3 Preparation before running the motor for a test--Setting function code data

Before running the motor, set function code data specified in Table 4.1 to the motor ratings and your system design values. For the motor, check the rated values printed on the nameplate of the motor. For your system design values, ask system designers about them.

 For details about how to change function code data, refer to Chapter 3, Section 3.4.1 "Setting up function codes quickly." Refer to the function code H03 in Chapter 5 "FUNCTION CODES" for the factory default setting of motor parameters. If any of them is different from the default setting, change the function code data.

Table 4.1 Settings of Function Code Data before Driving the Motor for a Test

Function code	Name	Function code data	Factory setting
<i>F 04 (R 02)</i>	Base frequency	Motor ratings (printed on the nameplate of the motor)	60.0 (Hz)
<i>F 05 (R 03)</i>	Rated voltage at base frequency		Three-phase 230 V class series: 230 (V) Three-phase 460 V class series: 460 (V)
<i>P 02 (R 16)</i>	Motor parameter (Rated capacity)		Applicable motor rated capacity
<i>P 03 (R 17)</i>	Motor parameter (Rated current)		Rated current of applicable motor
<i>P 99 (R 39)</i>	Motor selection		0: Motor characteristics 0 (Fuji standard 8-series motors)
<i>F 03 (R 01)</i>	Maximum frequency		System design values * For a test-driving of the motor, increase values so that they are longer than your system design values. If the set time is short, the inverter may not start running the motor.
<i>F 07</i>	Acceleration time 1*		6.0 (s)
<i>F 08</i>	Deceleration time 1*		6.0 (s)



In any of the following cases, the default settings may not produce the best results for auto torque boost, torque calculation monitoring, auto energy saving, torque limiter, automatic deceleration, auto search for idling motor speed, slip compensation, torque vector, droop control, or overload stop, since the standard settings of motor parameters for Fuji motors are not applicable. Tune the motor parameters according to the procedure set forth below.

- The motor to be driven is not a Fuji product or is a non-standard product.
- The cabling between the motor and the inverter is long.
- A reactor is inserted between the motor and the inverter.

A codes are used to specify the data for motor 2. Use them if necessary.

<Tuning procedure>

#### 1) Preparation

Referring to the rating plate on the motor, set the following function codes to their nominal ratings:

- F04 and A02: Base frequency
- F05 and A03: Rated voltage at base frequency
- P02 and A16: Rated capacity
- P03 and A17: Rated current



## 2) Selection of tuning process

Check the situation of the machine system and choose between "Tuning while the motor is stopped (P04 or A18 = 1)" and "Tuning while the motor is running (P04 or A18 = 2)." In the case of "Tuning while the motor is running (P04 or A18 = 2)," also adjust the acceleration and deceleration times (F07 and F08) and set the rotation direction properly so that it matches the actual rotation direction of the machine system.

Data for P04, A18	Motor parameters subjected to tuning:	Tuning type	Selection condition of tuning type
1	Primary resistance (%R1) Leakage reactance (%X)	Tuning the %R1 and %X, <u>with the motor being stopped.</u>	The motor cannot be rotated, or more than 50% of the rated load would be applied on the motor if rotated.
2	Primary resistance (%R1) Leakage reactance (%X) No-load current Rated slip frequency	Tuning the %R1, %X and rated slip frequency, <u>with the motor being stopped.</u> Tuning the no-load current, <u>with the motor running</u> at 50% of the base frequency. Lastly, tuning the rated slip frequency, <u>with the motor being stopped.</u>	Even if the motor is rotated, it is safe and the load applied on the motor would be no more than 50% of the rating. (If you do the tuning with no load, you will get the highest precision.)

Upon completion of the tuning, each motor parameter will be automatically saved into the applicable function code.

## 3) Preparation of machine system

Perform appropriate preparations on the motor and its load, such as disengaging the coupling and deactivating the safety device.

Switch to the motor 1 or motor 2, which the tuning is to be performed on.

Tuning results by P04 will be applied to P codes for the motor 1, and the tuning results by A18 will be applied to A codes for the motor 2.



Assigning the command "Switch to motor 2 **SWM2**" to any of the terminal [Y1], [Y2], or [30A/B/C] will automatically switch the output status of **SWM2** depending on the motor selected for the tuning.

## 4) Perform tuning

- ① Set function code P04 or A18 to "1" or "2" and press the key. (The blinking of / or  $\epsilon^2$  on the LED monitor will slow down.)
- ② Enter a run command for the rotation direction selected. The factory default is " key on the keypad for forward rotation." To switch to reverse rotation, change the data of function code F02.
- ③ The display of / or  $\epsilon^2$  stays lit, and tuning takes place while the motor being stopped. (Maximum tuning time: Approx. 40 s.)
- ④ If P04 or A18 = 2, the motor is accelerated to approximately 50% of the base frequency and then tuning takes place. Upon completion of measurements, the motor will decelerate to a stop.
- ⑤ Tuning will continue after the motor is stopped. (Maximum tuning time: Approx. 10 s.)
- ⑥ If the terminal signal **FWD** or **REV** is selected as the run command (F02 = 1),  $\epsilon_{nd}$  will appear upon completion of the measurements.
- ⑦ The run command is turned OFF. (The run command given through the keypad or the communications link is automatically turned OFF).  
The tuning completes and the next function code **P05** or **A20** appears on the keypad.

#### ■ Errors during tuning

Improper tuning would negatively affect the operation performance and, in the worst case, could even cause hunting or deteriorate precision. Therefore, if the inverter finds any abnormality in the results of the tuning or any error in the process of the tuning, it will display  $\overline{E-7}$  and discard the tuning data.

Listed below are the abnormal or error conditions that can be recognized during tuning.

Possible tuning error causes	Details
Error in tuning results	- An interphase voltage unbalance has been detected. - Tuning has resulted in an abnormally high or low value of a parameter.
Output current error	An abnormally high current has flown during tuning.
Sequence error	During tuning, a run command has been turned OFF, or <b>STOP</b> (Force to stop), <b>BX</b> (Coast to a stop), <b>DWP</b> (Protect from dew condensation), or other similar terminal command has been received.
Error due to limitation	- During tuning, any of the operation limiters has been activated. - The maximum frequency or the frequency limiter (high) has limited tuning operation.
Other errors	An undervoltage or any other alarm has occurred.

If any of these conditions has occurred, either eliminate the abnormal or error factor(s) and perform tuning again, or consult your Fuji Electric representative.



If a filter other than Fuji optional output filter (OFL-□□□-4A) is connected to the inverter's output (secondary) circuit, the result of tuning can be unpredictable. When you replace an inverter, make a note of the old inverter's settings for the primary resistance %R1, leakage reactance %X, no-load current, and rated slip frequency, and set those values to the new inverter's function codes.

#### 4.1.4 Test run

### WARNING

If the user specifies the function codes wrongly or without completely understanding this Instruction Manual and the FRENIC-Multi User's Manual, the motor may rotate with a torque or at a speed not permitted for the machine.

**Accident or injury may result.**

Follow the descriptions given in Section 4.1.1, "Inspection and preparation prior to powering on" to Section 4.1.3, "Preparation before running the motor for a test," then begin test-driving of the motor.

### CAUTION

If any abnormality is found in the inverter or motor, immediately stop operation and determine the cause referring to Chapter 6, "TROUBLESHOOTING."

## Test Run Procedure

- Turn the power ON and check that the reference frequency  $0.00$  Hz is blinking on the LED monitor.
- Set a low reference frequency such as 5 Hz, using  $\triangle$  /  $\nabla$  keys. (Check that the frequency is blinking on the LED monitor.)
- Press the  $\rightarrow$  key to start running the motor in the forward direction. (Check that the reference frequency is displayed on the LED monitor.)
- To stop the motor, press the  $\leftarrow$  key.

### < Check points during a test run >

- Check that the motor is running in the forward direction.
- Check for smooth rotation without motor humming or excessive vibration.
- Check for smooth acceleration and deceleration.

When no abnormality is found, press the  $\rightarrow$  key again to start driving the motor, then increase the reference frequency using  $\triangle$  /  $\nabla$  keys. Check the above points again.

If any problem is found, modify the function code data again as described below.

## 4.2 Operation

After confirming that the inverter normally drives the motor in a test run, make mechanical connections (connections to the machine system) and electrical connections (wiring and cabling), and configure the necessary function codes properly before starting a production run.



Depending on the production run conditions, further adjustments can be required, such as adjustments of torque boost (F09/A05), acceleration time (F07/E10), and deceleration time (F08/E11).

### 4.2.1 Jogging Operation

This section provides the procedure for jogging the motor.

- Making the inverter ready to jog with the steps below. The LED monitor should display  $0.00$ .
  - Enter Running mode (see page 3-3).
  - Press the  $\rightarrow$  +  $\triangle$  keys simultaneously. The LED monitor displays the jogging frequency for approximately one second and then returns to  $0.00$  again.
    -  Tip • Function codes C20 and H54 specify the jogging frequency and acceleration/ deceleration time, respectively. Use these function codes exclusively for the jogging operation with your needs.
    - Using the input terminal command "Ready for jogging" **JOG** switches between the normal operation state and ready-to-jog state.
    - Switching between the normal operation state and read-to-jog state with the  $\rightarrow$  +  $\triangle$  keys is possible only when the inverter is stopped.
- Jogging the motor.

Hold down the  $\rightarrow$  key during which the motor continues jogging. To decelerate to stop the motor, release the key.
- Exiting the ready-to-jog state and returning to the normal operation state  
Press the  $\rightarrow$  +  $\triangle$  keys simultaneously.

## Chapter 5 FUNCTION CODES

### 5.1 Function Code Tables

The following tables list the function codes available for the FRENIC-Multi series of inverters.

#### F codes: Fundamental Functions

Code	Name	Data setting range	Increment	Unit	Change when running	Data copying	Default setting	Refer to page:
F00	Data Protection	0: Disable both data protection and digital reference protection 1: Enable data protection and disable digital reference protection 2: Disable data protection and enable digital reference protection 3: Enable both data protection and digital reference protection	—	—	Y	Y	0	5-18
F01	Frequency Command 1	0: UP/DOWN keys on keypad 1: Voltage input to terminal [I2] (-10 to +10 VDC) 2: Current input to terminal [C1] (C1 function) (4 to 20 mA DC) 3: Sum of voltage and current inputs to terminals [I2] and [C1] (C1 function) 5: Voltage input to terminal [C1] (V2 function) (0 to 10 VDC) 7: Terminal command <b>UP/DOWN</b> control 11: Digital I/O interface option 12: PC interface card (option)	—	—	N	Y	0	
F02	Operation Method	0: RUN/STOP keys on keypad (Motor rotational direction specified by terminal command <b>FWD/REV</b> ) 1: Terminal command <b>FWD or REV</b> 2: RUN/STOP keys on keypad (forward) 3: RUN/STOP keys on keypad (reverse)	—	—	N	Y	2	5-20
F03	Maximum Frequency 1	25.0 to 400.0	0.1	Hz	N	Y	60.0	
F04	Base Frequency 1	25.0 to 400.0	0.1	Hz	N	Y	60.0	5-21
F05	Rated Voltage at Base Frequency 1	0: Output a voltage in proportion to input voltage 80 to 240: Output an AVR-controlled voltage (for 230 V class series) 160 to 500: Output an AVR-controlled voltage (for 460 V class series)	1	V	N	Y2	230 460	
F06	Maximum Output Voltage 1	80 to 240: Output an AVR-controlled voltage (for 230 V class series) 160 to 500: Output an AVR-controlled voltage (for 460 V class series)	1	V	N	Y2	230 460	
F07	Acceleration Time 1	0.00 to 3600 Note: Entering 0.00 cancels the acceleration time, requiring external soft-start.	0.01	s	Y	Y	6.00	5-22
F08	Deceleration Time 1	0.00 to 3600 Note: Entering 0.00 cancels the deceleration time, requiring external soft-start.	0.01	s	Y	Y	6.00	
F09	Torque Boost 1	0.0 to 20.0 (percentage with respect to "F05: Rated Voltage at Base Frequency 1") Note: This setting takes effect when F37 = 0, 1, 3, or 4.	0.1	%	Y	Y	*4	5-23
F10	Electronic Thermal Overload Protection for Motor 1 (Select motor characteristics)	1: For a general-purpose motor with shaft-driven cooling fan 2: For an inverter-driven motor, non-ventilated motor, or motor with separately powered cooling fan	—	—	Y	Y	1	5-25
F11	(Overload detection level)	0.00: Disable 0.01 to 100.00 1 to 135% of the rated current (allowable continuous drive current) of the motor	0.01	A	Y	Y1 Y2	*4	
F12	(Thermal time constant)	0.5 to 75.0	0.1	min	Y	Y	5.0	
F14	Restart Mode after Momentary Power Failure (Mode selection)	0: Disable restart (Trip immediately) 1: Disable restart (Trip after a recovery from power failure) 4: Enable restart (Restart at the frequency at which the power failure occurred, for general loads) 5: Enable restart (Restart at the starting frequency, for low-inertia load)	—	—	Y	Y	0	5-28
F15	Frequency Limiter (High)	0.0 to 400.0	0.1	Hz	Y	Y	70.0	5-31
F16	(Low)	0.0 to 400.0	0.1	Hz	Y	Y	0.0	
F18	Bias (Frequency command 1)	-100.00 to 100.00 *1	0.01	%	Y*	Y	0.00	5-32
F20	DC Braking 1 (Braking starting frequency)	0.0 to 60.0	0.1	Hz	Y	Y	0.0	5-33
F21	(Braking level)	0 to 100	1	%	Y	Y	0	
F22	(Braking time)	0.00: Disable 0.01 to 30.00	0.01	s	Y	Y	0.00	
F23	Starting Frequency 1	0.1 to 60.0	0.1	Hz	Y	Y	0.5	5-34
F24	(Holding time)	0.00 to 10.00	0.01	s	Y	Y	0.00	
F25	Stop Frequency	0.1 to 60.0	0.1	Hz	Y	Y	0.2	

The shaded function codes (  ) are applicable to the quick setup.

\*1 When you make settings from the keypad, the incremental unit is restricted by the number of digits that the LED monitor can display.

(Example) If the setting range is from -200.00 to 200.00, the incremental unit is:

"1" for -200 to -100, "0.1" for -99.9 to -10.0 and for 100.0 to 200.0, and "0.01" for -9.99 to -0.01 and for 0.00 to 99.99.

\*4 Default settings for these function codes vary depending on the inverter capacity. See Table 5.1 "Factory Defaults According to Inverter Capacity" on pages 5-15 and 5-16.

## (F codes continued)

Code	Name	Data setting range	Increment	Unit	Change when running	Data copying	Default setting	Refer to page:
F26	Motor Sound (Carrier frequency)	0.75 to 15	1	kHz	Y	Y	2	5-34
F27	(Tone)	0: Level 0 (inactive) 1: Level 1 2: Level 2 3: Level 3	—	—	Y	Y	0	
F29	Analog Output [FM] (Mode selection)	0: Output in voltage (0 to 10 VDC) ( <i>FMA</i> ) 2: Output in pulse (0 to 6000 p/s) ( <i>FMP</i> )	—	—	Y	Y	0	5-35
F30	(Voltage adjustment)	0 to 300 ( <i>FMA</i> )	1	%	Y*	Y	100	
F31	(Function)	Select a function to be monitored from the followings. 0: Output frequency 1 (before slip compensation) 1: Output frequency 2 (after slip compensation) 2: Output current 3: Output voltage 4: Output torque 5: Load factor 6: Input power 7: PID feedback amount (PV) 8: PG feedback value 9: DC link bus voltage 10: Universal AO 13: Motor output 14: Calibration 15: PID command (SV) 16: PID output (MV)	—	—	Y	Y	0	
F33	(Pulse rate)	25 to 6000 ( <i>FMP</i> , Pulse rate at 100% output)	1	p/s	Y*	Y	1440	
F37	Load Selection/Auto Torque Boost/ Auto Energy Saving Operation 1	0: Variable torque load 1: Constant torque load 2: Auto-torque boost 3: Auto-energy saving operation (Variable torque load during ACC/DEC) 4: Auto-energy saving operation (Constant torque load during ACC/DEC) 5: Auto-energy saving operation (Auto-torque boost during ACC/DEC)	—	—	N	Y	1	5-23
F39	Stop Frequency (Holding Time)	0.00 to 10.00	0.01	s	Y	Y	0.00	
F40	Torque Limiter 1 (Limiting level for driving)	20 to 200 999: Disable	1	%	Y	Y	999	5-36
F41	(Limiting level for braking)	20 to 200 999: Disable	1	%	Y	Y	999	
F42	Control Mode Selection 1	0: V/f control with slip compensation inactive 1: Dynamic torque vector control 2: V/f control with slip compensation active 3: V/f control with optional PG interface 4: Dynamic torque vector control with optional PG interface	—	—	N	Y	0	5-37
F43	Current Limiter (Mode selection)	0: Disable (No current limiter works.) 1: Enable at constant speed (Disable during ACC/DEC) 2: Enable during ACC/constant speed operation	—	—	Y	Y	2 (Note)	5-38
F44	(Level)	20 to 200 (The data is interpreted as the rated output current of the inverter for 100%.)	1	%	Y	Y	180 (Note)	
F50	Electronic Thermal Overload Protection for Braking Resistor (Discharging capability)	1 to 900 999: Disable 0: Reserved	1	kWs	Y	Y	999	
F51	(Allowable average loss)	0.001 to 50.000 0.000: Reserved	0.001	kW	Y	Y	0.000	

The shaded function codes ( ) are applicable to the quick setup.

(Note) Default settings for inverters with inverter's ROM version 0799 or earlier: F43 = 0 and F44 = 200 (For the inverter's ROM version checking procedure, refer to Chapter 3, Section 3.4.6 "Reading maintenance information".)

## E codes: Extension Terminal Functions

Code	Name	Data setting range	Increment	Unit	Change when running	Data copying	Default setting	Refer to page
E01	Terminal [X1] Function	Selecting function code data assigns the corresponding function to terminals [X1] to [X5] as listed below.	—	—	N	Y	0	5-40
E02	Terminal [X2] Function	0 (1000): Select multi-frequency (SS1)	—	—	N	Y	1	
E03	Terminal [X3] Function	1 (1001): Select multi-frequency (SS2)	—	—	N	Y	2	
E04	Terminal [X4] Function	2 (1002): Select multi-frequency (SS4)	—	—	N	Y	7	
E05	Terminal [X5] Function	3 (1003): Select multi-frequency (SS8)	—	—	N	Y	8	
		4 (1004): Select ACC/DEC time (RT1)						
		6 (1006): Enable 3-wire operation (HLD)						
		7 (1007): Coast to a stop (BX)						
		8 (1008): Reset alarm (RST)						
		9 (1009): Enable external alarm trip (THR)						
		10 (1010): Ready for jogging (JOG)						
		11 (1011): Select frequency command 2/1 (Hz/Hz)*						
		12 (1012): Select motor 2/motor 1 (M2/M1)						
		13 Enable DC braking (DCBRK)						
		14 (1014): Select torque limiter level (TL2/TL1)						
		17 (1017): UP (Increase output frequency) (UP)						
		18 (1018): DOWN (Decrease output) (DOWN)						
		19 (1019): Enable data change with keypad (WE-KP)						
		20 (1020): Cancel PID control (Hz/PID)						
		21 (1021): Switch normal/inverse operation (IVS)						
		24 (1024): Enable communications link via RS-485 or field bus (LE)						
		25 (1025): Universal DI (U-DI)						
		26 (1026): Enable auto search for idling motor speed at starting (STM)						
		27 (1027): Switch to speed feedback (PG/Hz)*5						
		30 (1030): Force to stop (STOP)						
		33 (1033): Reset PID integral and differential components (PID-RST)						
		34 (1034): Hold PID integral component (PID-HLD)						
		42 (1042): Activate the limit switch at start pc *						
		43 (1043): Start/reset (S/R)*5						
		44 (1044): Switch to the serial pulse receiving (SPRM)*5						
		45 (1045): Enter the return mode (RTN)*5						
		46 (1046): Enable overload stop (OLS)*5						
		Setting the value of 1000s in parentheses ( ) shown above assigns a negative logic input to a terminal. Note: In the case of <b>THR</b> and <b>STOP</b> , data (1009) and (1030) are for normal logic, and "9" and "30" are for negative logic, respectively.						
E10	Acceleration Time 2	0.00 to 3600 Note: Entering 0.00 cancels the acceleration time, requiring external soft-start and -stop.	0.01	s	Y	Y	10.0	5-22
E11	Deceleration Time 2	0.00 to 3600 Note: Entering 0.00 cancels the deceleration time, requiring external soft-start and -stop.	0.01	s	Y	Y	10.0	
E16	Torque Limiter 2 (Limiting level for driving)	20 to 200 999 - Disable	1	%	Y	Y	999	5-36
E17	(Limiting level for braking)	20 to 200 999 - Disable	1	%	Y	Y	999	

\*5 These are available on inverters with inverter's ROM version 0700 or later. (For the version checking procedure, refer to Chapter 3, Section 3.4.6 "Reading maintenance information.")

## (E codes continued)

Code	Name	Data setting range	Increment	Unit	Change when running	Data copying	Default setting	Refer to page:
E20	Terminal [Y1] Function	Selecting function code data assigns the corresponding function to terminals [Y1], [Y2], and [30A/B/C] as listed below.	—	—	N	Y	0	5-48
E21	Terminal [Y2] Function	0 (1000): Inverter running (RUN)	—	—	N	Y	7	
E27	Terminal [30A/B/C] Function	1 (1001): Frequency arrival signal (FAR)	—	—	N	Y	99	
		2 (1002): Frequency detected (FDT)						
		3 (1003): Undervoltage detected (Inverter stopped) (LU)						
		4 (1004): Torque polarity detected (B/D)						
		5 (1005): Inverter output limiting (IOL)						
		6 (1006): Auto-restarting after momentary power failure (IPF)						
		7 (1007): Motor overload early warning (OL)						
		10 (1010): Inverter ready to run (RDY)						
		21 (1021): Frequency arrival signal 2 (FAR2)						
		22 (1022): Inverter output limiting with delay (IOL2)						
		26 (1026): Auto-resetting (TRY)						
		27 (1027): Universal DO (U-DO)*6						
		28 (1028): Heat sink overheat early warning (OH)						
		30 (1030): Service lifetime alarm (LIFE)						
		33 (1033): Reference loss detected (REF OFF)						
		35 (1035): Inverter output on (RUN2)						
		36 (1036): Overload prevention control (OLP)						
		37 (1037): Current detected (ID)						
		38 (1038): Current detected 2 (ID2)						
		42 (1042): PID alarm (PID-ALM)						
		49 (1049): Switched to motor 2 (SWM2)						
		56 (1056): Motor overheat detected by thermistor (PTC) (THM)*6						
		57 (1057): Brake signal (BRKS)						
		59 (1059): Terminal [C1] wire break (C1OFF)*6						
		76 (1076): PG error detected (PG-ERR)*5						
		80 (1080): Stop position override alarm (OT)*5						
		81 (1081): Timer output (TO)*5						
		82 (1082): Positioning completed (PSET)*5						
		83 (1083): Current position count overflowed (POF)*5						
		99 (1099): Alarm output (for any alarm) (ALM)						
		Setting the value of 1000s in parentheses ( ) shown above assigns a negative logic input to a terminal.						
E29	Frequency Arrival Delay Time	0.01 to 10.00	0.01	s	Y	Y	0.10	5-52
E30	Frequency Arrival (Hysteresis width)	0.0 to 10.0	0.1	Hz	Y	Y	2.5	
E31	Frequency Detection (FDT) (Detection level) (Hysteresis width)	0.0 to 400.0	0.1	Hz	Y	Y	60.0	-
E32	Overload Early Warning/Current Detection (Level)	0.00 : Disable Current value of 1 to 200% of the inverter rated current	0.01	A	Y	Y1 Y2	*4	5-52
E35	(Timer)	0.01 to 600.00*1	0.01	s	Y	Y	10.00	
E37	Current Detection 2 (Level)	0.00 : Disable Current value of 1 to 200% of the inverter rated current	0.01	A	Y	Y1 Y2	*4	
E38	(Timer)	0.01 to 600.00*1	0.01	s	Y	Y	10.00	
E39	Coefficient for Constant Feeding Rate Time	0.000 to 9.999	0.001	—	Y	Y	0.000	5-53

\*1 When you make settings from the keypad, the incremental unit is restricted by the number of digits that the LED monitor can display.

(Example) If the setting range is from -200.00 to 200.00, the incremental unit is:

"1" for -200 to -100, "0.1" for -99.9 to -10.0 and for 100.0 to 200.0, and "0.01" for -9.99 to -0.01 and for 0.00 to 99.99.

\*4 Default settings for these function codes vary depending on the inverter capacity. See Table 5.1 "Factory Defaults According to Inverter Capacity" on pages 5-15 and 5-16.

\*5 These are available on inverters with inverter's ROM version 0700 or later. (For the version checking procedure, refer to Chapter 3, Section 3.4.6 "Reading maintenance information.")

\*6 These are available on inverters with inverter's ROM version 0800 or later. (For the version checking procedure, refer to Chapter 3, Section 3.4.6 "Reading maintenance information.")

## (E codes continued)

Code	Name	Data setting range	Increment	Unit	Change when running	Data copying	Default setting	Refer to page:
E40	PID Display Coefficient A	-999 to 0.00 to 9990 *1	0.01	—	Y	Y	100	—
E41	PID Display Coefficient B	-999 to 0.00 to 9990 *1	0.01	—	Y	Y	0.00	—
E42	LED Display Filter	0.0 to 5.0	0.1	s	Y	Y	0.5	—
E43	LED Monitor (Item selection)	0: Speed monitor (select by E48) 3: Output current 4: Output voltage 8: Calculated torque 9: Input power 10: PID command 12: PID feedback amount 13: Timer 14: PID output 15: Load factor 16: Motor output 21: Current position pulse count *5 22: Position deviation pulse count *5	—	—	Y	Y	0	—
E45	LCD Monitor *3 (Item selection)	0: Running status, rotational direction and operation guide 1: Bar charts for output frequency, current and calculated torque	—	—	Y	Y	0	—
E46	(Language selection)	0: Japanese 1: English 2: German 3: French 4: Spanish 5: Italian	—	—	Y	Y	1	—
E47	(Contrast control)	0 (Low) to 10 (High)	1	—	Y	Y	5	—
E48	LED Monitor (Speed monitor item)	0: Output frequency (Before slip compensation) 1: Output frequency (After slip compensation) 2: Reference frequency 3: Motor speed in r/min 4: Load shaft speed in r/min 5: Line speed in m/min 6: Constant feeding rate time	—	—	Y	Y	0	—
E50	Coefficient for Speed Indication	0.01 to 200.00 *1	0.01	—	Y	Y	30.00	5-53
E51	Display Coefficient for Input Watt-hour Data	0.000 (Cancel/reset) 0.001 to 9999	0.001	—	Y	Y	0.010	—
E52	Keypad (Menu display mode)	0: Function code data editing mode (Menus #0 and #1) 1: Function code data check mode (Menu #2) 2: Full-menu mode (Menus #0 through #6)	—	—	Y	Y	0	—
E59	Terminal [C1] Signal Definition (C1/V2 Function)	0: Current input (C1 function), 4 to 20 mA DC 1: Voltage input (V2 function), 0 to +10 VDC	—	—	N	Y	0	5-53
E61	Terminal [12] Extended Function	Selecting function code data assigns the corresponding function to terminals [12] and [C1] (C1/V2 function) as listed below.	—	—	N	Y	0	5-54
E62	Terminal [C1] Extended Function (C1 function)	0: None 1: Auxiliary frequency command 1	—	—	N	Y	0	—
E63	Terminal [C1] Extended Function (V2 function)	2: Auxiliary frequency command 2 3: PID command 1 5: PID feedback amount	—	—	N	Y	0	—
E65	Reference Loss Detection (Continuous running frequency)	0: Decelerate to stop 20 to 120 999: Disable	1	%	Y	Y	999	—

The shaded function codes (   ) are applicable to the quick setup.

\*1 When you make settings from the keypad, the incremental unit is restricted by the number of digits that the LED monitor can display.

(Example) If the setting range is from -200.00 to 200.00, the incremental unit is:

"1" for -200 to -100, "0.1" for -99.9 to -10.0 and for 100.0 to 200.0, and "0.01" for -9.99 to -0.01 and for 0.00 to 99.99.

\*3 These function codes are for use with an optional multi-function keypad.

\*5 These are available on inverters with inverter's ROM version 0700 or later. (For the version checking procedure, refer to Chapter 3, Section 3.4.6 "Reading maintenance information.")



## (E codes continued)

Code	Name	Data setting range	Incre- ment	Unit	Change when running	Data copying	Default setting	Refer to page:
E98	Terminal [FWD] Function	Selecting function code data assigns the corresponding function to terminals [FWD] and [REV] as listed below.	—	—	N	Y	98	5-40
E99	Terminal [REV] Function	0 (1000): Select multi-frequency ( <i>SS1</i> ) 1 (1001): Select multi-frequency ( <i>SS2</i> ) 2 (1002): Select multi-frequency ( <i>SS4</i> ) 3 (1003): Select multi-frequency ( <i>SS8</i> ) 4 (1004): Select ACC/DEC time ( <i>RT1</i> ) 6 (1006): Enable 3-wire operation ( <i>HLD</i> ) 7 (1007): Coast to a stop ( <i>BX</i> ) 8 (1008): Reset alarm ( <i>RST</i> ) 9 (1009): Enable external alarm trip ( <i>THR</i> ) 10 (1010): Ready for jogging ( <i>JOG</i> ) 11 (1011): Select frequency command 2/1 ( <i>Hz2Hz1</i> ) 12 (1012): Select motor 2/motor 1 ( <i>M2/M1</i> ) 13 : Enable DC braking ( <i>DCBRK</i> ) 14 (1014): Select torque limiter level ( <i>TL2/TL1</i> ) 17 (1017): UP (Increase output frequency) ( <i>UP</i> ) 18 (1018): DOWN (Decrease output frequency) ( <i>DOWN</i> ) 19 (1019): Enable data change with keypad ( <i>WE-KP</i> ) 20 (1020): Cancel PID control ( <i>HzPID</i> ) 21 (1021): Switch normal/inverse operation ( <i>IVS</i> ) 24 (1024): Enable communications link via RS-485 or field bus ( <i>LE</i> ) 25 (1025): Universal DI ( <i>U-DI</i> ) 26 (1026): Enable auto search for idling motor speed at starting ( <i>STM</i> ) 27 (1027): Switch to speed feedback ( <i>PG/Hz</i> ) <sup>*5</sup> 30 (1030): Force to stop ( <i>STOP</i> ) 33 (1033): Reset PID integral and differential components ( <i>PID-RST</i> ) 34 (1034): Hold PID integral component ( <i>PID-HLD</i> ) 42 (1042): Activate the limit switch at start pc ( <i>LS</i> ) <sup>*5</sup> 43 (1043): Start/reset ( <i>SR</i> ) <sup>*5</sup> 44 (1044): Switch to the serial pulse receiving ( <i>SPRM</i> ) <sup>*5</sup> 45 (1045): Enter the return mode ( <i>RTN</i> ) <sup>*5</sup> 46 (1046): Enable overload stop ( <i>OLS</i> ) <sup>*5</sup> 98 : Run forward ( <i>FWD</i> ) 99 : Run reverse ( <i>REV</i> ) Setting the value of 1000s in parentheses ( ) shown above assigns a negative logic input to a terminal. Note: In the case of <i>THR</i> and <i>STOP</i> , data (1009) and (1030) are for normal logic, and "9" and "30" are for negative logic, respectively.	—	—	N	Y	99	

\*5 These are available on inverters with inverter's ROM version 0700 or later. (For the version checking procedure, refer to Chapter 3, Section 3.4.6 "Reading maintenance information.")

## C codes: Control Functions

Code	Name	Data setting range	Increment	Unit	Change when running	Data copying	Default setting	Refer to page:
C01	Jump Frequency 1	0.0 to 400.0	0.1	Hz	Y	Y	0.0	-
C02	2				Y	Y	0.0	
C03	3				Y	Y	0.0	
C04	(Hysteresis width)	0.0 to 30.0	0.1	Hz	Y	Y	3.0	
C05	Multi-Frequency 1	0.00 to 400.00 *1	0.01	Hz	Y	Y	0.00	
C06	2				Y	Y	0.00	
C07	3				Y	Y	0.00	
C08	4				Y	Y	0.00	
C09	5				Y	Y	0.00	
C10	6				Y	Y	0.00	
C11	7				Y	Y	0.00	
C12	8				Y	Y	0.00	
C13	9				Y	Y	0.00	
C14	10				Y	Y	0.00	
C15	11				Y	Y	0.00	
C16	12				Y	Y	0.00	
C17	13				Y	Y	0.00	
C18	14				Y	Y	0.00	
C19	15				Y	Y	0.00	
C20	Jogging Frequency	0.00 to 400.00 *1	0.01	Hz	Y	Y	0.00	
C21	Timer Operation	0: Disable 1: Enable	-	-	N	Y	0	5-55
C30	Frequency Command 2	0: UP/DOWN keys on keypad 1: Voltage input to terminal [12] (-10 to +10 VDC) 2: Current input to terminal [C1] (C1 function) (4 to 20 mA DC) 3: Sum of voltage and current inputs to terminals [12] and [C1] (C1 function) 5: Voltage input to terminal [C1] (V2 function) (0 to 10 VDC) 7: Terminal command <b>UP/DOWN</b> control 11: Digital I/O interface option 12: PG interface card (option)	-	-	N	Y	2	5-18
C31	Analog Input Adjustment for [12]	-5.0 to 5.0	0.1	%	Y*	Y	0.0	5-55
	(Offset)							
C32	(Gain)	0.00 to 200.00 *1	0.01	%	Y*	Y	100.0	5-32
C33	(Filter time constant)	0.00 to 5.00	0.01	s	Y	Y	0.05	5-55
C34	(Gain base point)	0.00 to 100.00 *1	0.01	%	Y*	Y	100.0	5-32
C35	(Polarity)	0: Bipolar 1: Unipolar	-	-	N	Y	1	-
C36	Analog Input Adjustment for [C1]	-5.0 to 5.0	0.1	%	Y*	Y	0.0	5-55
	(C1 function)							
C37	(Offset)							
C38	(Gain)	0.00 to 200.00 *1	0.01	%	Y*	Y	100.0	5-32
C39	(Filter time constant)	0.00 to 5.00	0.01	s	Y	Y	0.05	5-55
C40	(Gain base point)	0.00 to 100.00 *1	0.01	%	Y*	Y	100.0	5-32
C41	Analog Input Adjustment for [C1]	-5.0 to 5.0	0.1	%	Y*	Y	0.0	5-55
	(V2 function)							
C42	(Offset)							
C43	(Gain)	0.00 to 200.00 *1	0.01	%	Y*	Y	100.0	5-32
C44	(Filter time constant)	0.00 to 5.00	0.01	s	Y	Y	0.05	5-55
C45	(Gain base point)	0.00 to 100.00 *1	0.01	%	Y*	Y	100.0	5-32
C50	Bias (Frequency command 1)	0.00 to 100.00 *1	0.01	%	Y*	Y	0.00	
	(Bias base point)							
C51	Bias (PID command 1)	-100.00 to 100.00						-
	(Bias value)		0.01	%	Y*	Y	0.00	
C52	(Bias base point)	0.00 to 100.00 *1	0.01	%	Y*	Y	0.00	
C53	Selection of Normal/Inverse Operation	0: Normal operation 1: Inverse operation	-	-	Y	Y	0	

\*1 When you make settings from the keypad, the incremental unit is restricted by the number of digits that the LED monitor can display.

(Example) If the setting range is from -200.00 to 200.00, the incremental unit is:

"1" for -200 to -100, "0.1" for -99.9 to -10.0 and for 100.0 to 200.0, and "0.01" for -9.99 to -0.01 and for 0.00 to 99.99.

## P codes: Motor 1 Parameters

Code	Name	Data setting range	Increment	Unit	Change when running	Data copying	Default setting	Refer to page:
P01	Motor 1 (No. of poles)	2 to 22	2	poles	N	Y1 Y2	4	5-56
P02	(Rated capacity)	0.01 to 30.00 (where, P99 data is 0, 3, or 4.) 0.01 to 30.00 (where, P99 data is 1.)	0.01	kW HP	N	Y1 Y2	*4	
P03	(Rated current)	0.00 to 100.0	0.01	A	N	Y1 Y2	Rated value of Fuji standard motor	
P04	(Auto-tuning)	0: Disable 1: Enable (Tune %R1 and %X while the motor is stopped.) 2: Enable (Tune %R1, %X and rated slip while the motor is stopped, and no-load current while running.)	—	—	N	N	0	
P05	(Online tuning)	0: Disable 1: Enable	—	—	Y	Y	0	
P06	(No-load current)	0.00 to 50.00	0.01	A	N	Y1 Y2	Rated value of Fuji standard motor	
P07	(%R1)	0.00 to 50.00	0.01	%	Y	Y1 Y2	Rated value of Fuji standard motor	
P08	(%X)	0.00 to 50.00	0.01	%	Y	Y1 Y2	Rated value of Fuji standard motor	
P09	(Slip compensation gain for driving)	0.0 to 200.0	0.1	%	Y*	Y	100.0	5-57
P10	(Slip compensation response time)	0.01 to 10.00	0.01	s	Y	Y1 Y2	0.50	
P11	(Slip compensation gain for braking)	0.0 to 200.0	0.1	%	Y*	Y	100.0	
P12	(Rated slip frequency)	0.00 to 15.00	0.01	Hz	N	Y1 Y2	Rated value of Fuji standard motor	5-56
P99	Motor 1 Selection	0: Motor characteristics 0 (Fuji standard motors, 8-series) 1: Motor characteristics 1 (HP rating motors) 3: Motor characteristics 3 (Fuji standard motors, 6-series) 4: Other motors	—	—	N	Y1 Y2	0	5-57

The shaded function codes (  ) are applicable to the quick setup.

\*4 Default settings for these function codes vary depending on the inverter capacity. See Table 5.1 "Factory Defaults According to Inverter Capacity" on pages 5-15 and 5-16.

## H codes: High Performance Functions

Code	Name	Data setting range	Increment	Unit	Change when running	Data copying	Default setting	Refer to page:
H03	Data Initialization	0: Disable initialization 1: Initialize all function code data to the factory defaults 2: Initialize motor 1 parameters 3: Initialize motor 2 parameters	—	—	N	N	0	5-58
H04	Auto-reset (Times)	0: Disable 1 to 10	1	times	Y	Y	0	5-63
H05	(Reset Interval)	0.5 to 20.0	0.1	s	—	Y	5.0	
H06	Cooling Fan ON/OFF Control	0: Disable (Always in operation) 1: Enable (ON/OFF controllable)	—	—	Y	Y	0	5-64
H07	Acceleration/Deceleration Pattern	0: Linear 1: S-curve (Weak) 2: S-curve (Strong) 3: Curvilinear	—	—	Y	Y	0	
H08	Rotational Direction Limitation	0: Disable 1: Enable (Reverse rotation inhibited) 2: Enable (Forward rotation inhibited)	—	—	N	Y	0	—
H09	Starting Mode (Auto search)	0: Disable 1: Enable (At restart after momentary power failure) 2: Enable (At restart after momentary power failure and at normal start)	—	—	N	Y	0	5-65
H11	Deceleration Mode	0: Normal deceleration 1: Coast-to-stop	—	—	Y	Y	0	5-67
H12	Instantaneous Overcurrent Limiting (Mode selection)	0: Disable 1: Enable	—	—	Y	Y	1	
H13	Restart Mode after Momentary Power Failure (Restart time)	0.1 to 10.0	0.1	s	Y	Y1 Y2	*4	5-28
H14	(Frequency fall rate)	0.00: Deceleration time selected by F08 0.01 to 100.00 999: Follow the current limit command	0.01	Hz/s	Y	Y	999	
H16	(Allowable momentary power failure time)	0.0 to 30.0 999: Automatically determined by inverter	0.1	s	Y	Y	999	
H26	Thermistor (Mode selection)	0: Disable 1: Enable (With PTC, the inverter immediately trips with $\overline{OH}$ displayed.) 2: Enable (With PTC, the inverter issues output signal <b>THM</b> and continues to run. *6)	—	—	Y	Y	0	—
H27	(Level)	0.00 to 5.00	0.01	V	Y	Y	1.60	
H28	Droop Control	-60.0 to 0.0	0.1	Hz	Y	Y	0.0	5-68
H30	Communications Link Function (Mode selection)	Frequency command Run command 0: F01/C30 F02 1: RS-485 F02 2: F01/C30 RS-485 3: RS-485 RS-485 4: RS-485 (option) F02 5: RS-485 (option) RS-485 6: F01/C30 RS-485 (option) 7: RS-485 RS-485 (option) 8: RS-485 (option) RS-485 (option)	—	—	Y	Y	0	
H42	Capacitance of DC Link Bus Capacitor	Indication for replacing DC link bus capacitor (0000 to FFFF: Hexadecimal)	1	—	Y	N	—	—
H43	Cumulative Run Time of Cooling Fan	Indication of cumulative run time of cooling fan for replacement	—	—	Y	N	—	—
H44	Startup Times of Motor 1	Indication of cumulative startup times	—	—	Y	N	—	—
H45	Mock Alarm	0: Disable 1: Enable (Once a mock alarm occurs, the data automatically returns to 0.)	—	—	Y	N	0	5-70
H47	Initial Capacitance of DC Link Bus Capacitor	Indication for replacing DC link bus capacitor (0000 to FFFF: Hexadecimal)	—	—	Y	N	Set at factory shipping	—
H48	Cumulative Run Time of Capacitors on Printed Circuit Boards	Indication for replacing capacitors on printed circuit boards (0000 to FFFF: Hexadecimal). Resettable.	—	—	Y	N	—	—
H49	Starting Mode (Delay time)	0.0 to 10.0	0.1	s	Y	Y	0.0	5-65
H50	Non-linear V/f Pattern 1 (Frequency) (Voltage)	0.0 : Cancel 0.1 to 400.0 0 to 240 : Output an AVR-controlled voltage (for 200 V class series) 0 to 500 : Output an AVR-controlled voltage (for 400 V class series)	0.1	Hz	N	Y	0.0	5-21
H51	(Frequency) (Voltage)	0 to 240 : Output an AVR-controlled voltage (for 200 V class series) 0 to 500 : Output an AVR-controlled voltage (for 400 V class series)	1	V	N	Y2	0	
H52	Non-linear V/f Pattern 2 (Frequency) (Voltage)	0.0 : Cancel 0.1 to 400.0 0 to 240 : Output an AVR-controlled voltage (for 200 V class series) 0 to 500 : Output an AVR-controlled voltage (for 400 V class series)	0.1	Hz	N	Y	0.0	
H53	(Frequency) (Voltage)	0 to 240 : Output an AVR-controlled voltage (for 200 V class series) 0 to 500 : Output an AVR-controlled voltage (for 400 V class series)	1	V	N	Y2	0	

\*4 Default settings for these function codes vary depending on the inverter capacity. See Table 5.1 "Factory Defaults According to Inverter Capacity" on pages 5-15 and 5-16.

\*6 These are available on inverters with inverter's ROM version 0800 or later. (For the version checking procedure, refer to Chapter 3, Section 3.4.6 "Reading maintenance information.")

## (H codes continued)

Code	Name	Data setting range	Increment	Unit	Change when running	Data copying	Default setting	Refer to page:
H54	ACC/DEC Time (Jogging operation)	0.00 to 3600 ACC time and DEC time are common.	0.01	s	Y	Y	6.00	-
H56	Deceleration Time for Forced Stop	0.00 to 3600	0.01	s	Y	Y	6.00	
H61	UP/DOWN Control (Initial frequency setting)	0: 0.00 1: Last UP/DOWN command value on releasing run command	-	-	N	Y	1	
H63	Low Limiter (Mode selection)	0: Limit by F16 (Frequency limiter: Low) and continue to run 1: If the output frequency lowers below the one limited by F16 (Frequency limiter: Low), decelerate to stop the motor.	-	-	Y	Y	0	5-31
H64	(Lower limiting frequency)	0.0 (Depends on F16 (Frequency limiter: Low)) 0.1 to 60.0	0.1	Hz	Y	Y	1.6	-
H68	Slip Compensation 1 (Operating conditions)	0: Enable during ACC/DEC and enable at base frequency or above 1: Disable during ACC/DEC and enable at base frequency or above 2: Enable during ACC/DEC and disable at base frequency or above 3: Disable during ACC/DEC and disable at base frequency or above	-	-	N	Y	0	5-37
H69	Automatic Deceleration (Mode selection)	0: Disable 2: Enable (Canceled if actual deceleration time exceeds three times the one specified by F08/E11.) 4: Enable (Not canceled if actual deceleration time exceeds three times the one specified by F08/E11.)	-	-	Y	Y	0	5-70
H70	Overload Prevention Control	0.00 : Follow deceleration time specified by F08/E11 0.01 to 100.0 999: Disable	0.01	Hz/s	Y	Y	999	5-71
H71	Deceleration Characteristics	0: Disable 1: Enable	-	-	Y	Y	0	
H76	Torque Limiter (Frequency increment limit for braking)	0.0 to 400.0	0.1	Hz	Y	Y	5.0	5-70
H80	Output Current Fluctuation Damping Gain for Motor 1	0.00 to 0.40	0.01	-	Y	Y	0.20	-
H89	Motor overload memory retention	0: Inactive 1: Active	-	-	Y	Y	1	
H90	Reserved *2	0: 1	-	-	Y	Y	0	
H91	C1 Disconnection Detection Time (PID control feedback line) *6	0.0: Disable 0.1 to 60.0: Detection time	0.1	s	Y	Y	0.0	
H94	Cumulative Motor Run Time 1	Change or reset the cumulative data	-	-	N	N	-	5-71
H95	DC Braking (Braking response mode)	0: Slow 1: Quick	-	-	Y	Y	1	5-33
H96	STOP Key Priority/Start Check Function	Data STOP key priority Start check function 0: Disable Disable 1: Enable Disable 2: Disable Enable 3: Enable Enable	-	-	Y	Y	0	-
H97	Clear Alarm Data	0: Does not clear alarm data 1: Clear alarm data and return to zero	-	-	Y	N	0	5-70
H98	Protection/Maintenance Function (Mode selection)	0 to 31: Display data on the keypad's LED monitor in decimal format (In each bit, "0" for disabled, "1" for enabled.) Bit 1: Lower the carrier frequency automatically Bit 2: Detect input phase loss Bit 3: Select life judgment threshold of DC link bus capacitor Bit 4: Judge the life of DC link bus capacitor	-	-	Y	Y	19 (bit4, 1,0=1)	5-71

## A codes: Motor 2 Parameters

Code	Name	Data setting range	Increment	Unit	Change when running	Data copying	Default setting	Refer to page:
A01	Maximum Frequency 2	25.0 to 400.0	0.1	Hz	N	Y	60.0	-
A02	Base Frequency 2	25.0 to 400.0	0.1	Hz	N	Y	60.0	
A03	Rated Voltage at Base Frequency 2	0: Output a voltage in proportion to input voltage 80 to 240: Output an AVR-controlled voltage (for 230 V class series) 160 to 500: Output an AVR-controlled voltage (for 460 V class series)	1	V	N	Y2	230 460	
A04	Maximum Output Voltage 2	80 to 240V: Output an AVR-controlled voltage (for 230 V class series) 160 to 500V: Output an AVR-controlled voltage (for 460 V class series)	1	V	N	Y2	230 460	

\*2 These function codes and their data are displayed, but they are reserved for particular manufacturers. Unless otherwise specified, do not access these function codes.

\*6 These are available on inverters with inverter's ROM version 0800 or later. (For the version checking procedure, refer to Chapter 3, Section 3.4.6 "Reading maintenance information.")

## (A codes continued)

Code	Name	Data setting range	Increment	Unit	Change when running	Data copying	Default setting	Refer to page:
A05	Torque Boost 2	0.0 to 20.0 (percentage with respect to "A03: Rated Voltage at Base Frequency 2") Note: This setting takes effect when A13 = 0, 1, 3, or 4.	0.1	%	Y	Y	*4	-
A06	Electronic Thermal Overload Protection for Motor 2 (Select motor characteristics)	1: For a general-purpose motor with shaft-driven cooling fan 2: For an inverter-driven motor, non-ventilated motor, or motor with separately powered cooling fan	—	—	Y	Y	1	
A07	(Overload detection level)	0.00: Disable 1 to 135% of the rated current (allowable continuous drive current) of the motor	0.01	A	Y	Y1 Y2	*4	
A08	(Thermal time constant)	0.5 to 75.0	0.1	min	Y	Y	5.0	
A09	DC Braking 2 (Braking starting frequency)	0.0 to 60.0	0.1	Hz	Y	Y	0.0	
A10	(Braking level)	0 to 100	1	%	Y	Y	0	
A11	(Braking time)	0.00: Disable 0.01 to 30.00	0.01	s	Y	Y	0.00	
A12	Starting Frequency 2	0.1 to 60.0	0.1	Hz	Y	Y	0.5	
A13	Load Selection/ Auto Torque Boost/ Auto Energy Saving Operation 2	0: Variable torque load 1: Constant torque load 2: Auto-torque boost 3: Auto-energy saving operation (Variable torque load during ACC/DEC) 4: Auto-energy saving operation (Constant torque load during ACC/DEC) 5: Auto-energy saving operation (Auto-torque boost during ACC/DEC)	—	—	N	Y	1	
A14	Control Mode Selection 2	0: V/f control with slip compensation inactive 1: Dynamic torque vector control 2: V/f control with slip compensation active 3: V/f control with optional PG interface 4: Dynamic torque vector control with optional PG interface	—	—	N	Y	0	
A15	Motor 2 (No. of poles)	2 to 22	2	poles	N	Y1 Y2	4	
A16	(Rated capacity)	0.01 to 30.00 (where, P99 data is 0, 3, or 4.) 0.01 to 30.00 (where, P99 data is 1.)	0.01 0.01	kW HP	N	Y1 Y2	*4	
A17	(Rated current)	0.00 to 100.0	0.01	A	N	Y1 Y2	Rated value of Fuji standard motor	
A18	(Auto-tuning)	0: Disable 1: Enable (Tune %R1 and %X while the motor is stopped.) 2: Enable (Tune %R1, %X and rated slip while the motor is stopped, and no-load current while running.)	—	—	N	N	0	
A19	(Online tuning)	0: Disable 1: Enable	—	—	Y	Y	0	
A20	(No-load current)	0.00 to 50.00	0.01	A	N	Y1 Y2	Rated value of Fuji standard motor	
A21	(%R1)	0.00 to 50.00	0.01	%	Y	Y1 Y2	Rated value of Fuji standard motor	
A22	(%X)	0.00 to 50.00	0.01	%	Y	Y1 Y2	Rated value of Fuji standard motor	
A23	(Slip compensation gain for driving)	0.0 to 200.0	0.1	%	Y*	Y	100.0	
A24	(Slip compensation response time)	0.01 to 10.00	0.01	s	Y	Y1	0.50	
A25	(Slip compensation gain for braking)	0.0 to 200.0	0.1	%	Y*	Y	100.0	
A26	(Rated slip frequency)	0.00 to 15.00	0.01	Hz	N	Y1 Y2	Rated value of Fuji standard motor	
A39	Motor 2 Selection	0: Motor characteristics 0 (Fuji standard motors, 8-series) 1: Motor characteristics 1 (HP rating motors) 3: Motor characteristics 3 (Fuji standard motors, 6-series) 4: Other motors	—	—	N	Y1 Y2	0	
A40	Slip Compensation 2 (Operating conditions)	0: Enable during ACC/DEC and enable at base frequency or above 1: Disable during ACC/DEC and enable at base frequency or above 2: Enable during ACC/DEC and disable at base frequency or above 3: Disable during ACC/DEC and disable at base frequency or above	—	—	N	Y	0	
A41	Output Current Fluctuation Damping Gain for Motor 2	0.00 to 0.40	0.01	—	Y	Y	0.20	
A45	Cumulative Motor Run Time 2	Change or reset the cumulative data	—	—	N	N	—	
A46	Startup Times of Motor 2	Indication of cumulative startup times	—	—	Y	N	—	

\*4 Default settings for these function codes vary depending on the inverter capacity. See Table 5.1 "Factory Defaults According to Inverter Capacity" on pages 5-15 and 5-16.

## J codes: Application Functions

Code	Name	Data setting range	Increment	Unit	Change when running	Data copying	Default setting	Refer to page:
J01	PID Control (Mode selection)	0: Disable 1: Enable (Process control, normal operation) 2: Enable (Process control, inverse operation) 3: Enable (Dancer control)	—	—	N	Y	0	—
J02	(Remote command SV)	0: UP/DOWN keys on keypad 1: PID command 1 3: Terminal command <b>UP/DOWN</b> control 4: Command via communications link	—	—	N	Y	0	
J03	P (Gain)	0.000 to 30.000 *1	0.001	times	Y	Y	0.100	
J04	I (Integral time)	0.0 to 3600.0 *1	0.1	s	Y	Y	0.0	
J05	D (Differential time)	0.00 to 600.00 *1	0.01	s	Y	Y	0.00	
J06	(Feedback filter)	0.0 to 900.0	0.1	s	Y	Y	0.5	
J10	(Anti reset windup)	0 to 200	1	%	Y	Y	200	
J11	(Select alarm output)	0: Absolute-value alarm 1: Absolute-value alarm (with Hold) 2: Absolute-value alarm (with Latch) 3: Absolute-value alarm (with Hold and Latch) 4: Deviation alarm 5: Deviation alarm (with Hold) 6: Deviation alarm (with Latch) 7: Deviation alarm (with Hold and Latch)	—	—	Y	Y	0	
J12	(Upper level alarm (AH))	-100 to 100	1	%	Y	Y	100	
J13	(Lower level alarm (AL))	-100 to 100	1	%	Y	Y	0	
J18	(Upper limit of PID process output)	-150 to 150	1	%	Y	Y	999	
J19	(Lower limit of PID process output)	-150 to 150 999: The F15 data applies.	1	%	Y	Y	999	
J56	(Speed command filter)	0.00 to 5.00	0.01	s	Y	Y	0.10	
J57	(Dancer reference position)	-100 to 100	1	%	Y	Y	0	
J58	(Detection width of dancer position deviation)	0: Disable switching PID constant 1 to 100	1	%	Y	Y	0	
J59	P (Gain) 2	0.000 to 30.000 *1	0.001	times	Y	Y	0.100	
J60	I (Integral time) 2	0.0 to 3600.0 *1	0.1	s	Y	Y	0.0	
J61	D (Differential time) 2	0.00 to 600.00 *1	0.01	s	Y	Y	0.00	
J62	(PID control block selection)	Bit 0: PID output polarity 0 = addition, 1 = subtraction Bit 1: Select compensation of output ratio 0 =Ratio (relative to the main setting) 1 = Speed command (relative to maximum frequency)	1	—	N	Y	0	
J63	Overload Stop (Detection value)	0: Torque 1: Current	—	—	Y	Y	0	5-73
J64	(Detection level)	20 to 200	0.1	%	Y	Y	100	
J65	(Mode selection)	0: Disable 1: Decelerate to stop 2: Coast to a stop 3: Hit and stop	—	—	N	Y	0	
J66	(Operation condition)	0: Enable at constant speed and during deceleration 1: Enable at constant speed 2: Enable anytime	—	—	Y	Y	0	
J67	(Timer)	0.00 to 600.00	0.01	s	Y	Y	0	
J68	Braking Signal (Brake OFF current)	0 to 200	1	%	Y	Y	100	5-74
J69	(Brake OFF frequency)	0.0 to 25.0	0.1	Hz	Y	Y	1.0	
J70	(Brake OFF timer)	0.0 to 5.0	0.1	s	Y	Y	1.0	
J71	(Brake ON frequency)	0.0 to 25.0	0.1	Hz	Y	Y	1.0	
J72	(Brake ON timer)	0.0 to 5.0	0.1	s	Y	Y	1.0	

\*1 When you make settings from the keypad, the incremental unit is restricted by the number of digits that the LED monitor can display.

(Example) If the setting range is from -200.00 to 200.00, the incremental unit is:





"1" for -200 to -100, "0.1" for -99.9 to -10.0 and for 100.0 to 200.0, and "0.01" for -9.99 to -0.01 and for 0.00 to 99.99.

## (J codes continued)

Code	Name	Data setting range	Increment	Unit	Change when running	Data copying	Default setting	Refer to page
J73	Positioning Control (Start timer)	0.0 to 1000.0	0.1	s	Y	Y	0.0	-
J74	(Start point; upper digits)	999 to 999	1	p	Y	Y	0	
J75	(Start point; lower digits)	[P] 0 to 9999 *7	1	p	Y	Y	0	
J76	(Preset point; upper digits)	999 to 999	1	p	Y	Y	0	
J77	(Preset point; lower digits)	[P] 0 to 9999 *7	1	p	Y	Y	0	
J78	(Creep speed SW point; upper digits)	0 to 999	1	p	Y	Y	0	
J79	(Creep speed SW point; lower digits)	0 to 9999	1	p	Y	Y	0	
J80	(Creep speed)	0 to 400	1	Hz	Y	Y	0	
J81	(End point; upper digits)	999 to 999	1	p	Y	Y	0	
J82	(End point; lower digits)	0 to 9999	1	p	Y	Y	0	
J83	(Positioning allowance)	0 to 9999	1	p	Y	Y	0	
J84	(End timer)	0.0 to 1000.0	0.1	s	Y	Y	0.0	
J85	(Coasting compensation)	0 to 9999	1	p	Y	Y	0	
J86	(End point command)	0, 1	—	—	Y	Y	0	
J87	(Preset positioning requirement)	0, 1, 2	—	—	N	Y	0	
J88	(Position detection direction)	0, 1	—	—	N	Y	0	
J90	Overload Stop Function P (Gain)	0.000 to 2.000, 999	0.001	—	Y	Y	999	
J91	I (Integral time)	0.001 to 9.999, 999	0.001	s	Y	Y	999	
J92	(Level adjustment)	50.0 to 150.0	0.1	%	Y	Y	100.0	

\*5 These are available on inverters with inverter's ROM version 0700 or later. (For the version checking procedure, refer to Chapter 3, Section 3.4.6 "Reading maintenance information.")

\*7 [P]: Current position (Absolute position)

Switching between "0" and [P] requires the simultaneous keying:  +  keys from "0" to [P] and  +  keys from [P] to "0."



## y codes: Link Functions

Code	Name	Data setting range	Increment	Unit	Change when running	Data copying	Default setting	Refer to page:
y01	RS-485 Communication (Standard) (Station address)	1 to 255	1	—	N	Y	1	—
y02	(Communications error processing)	0: Immediately trip with alarm $E-r\beta$ 1: Trip with alarm $E-r\beta$ after running for the period specified by timer y03 2: Retry during the period specified by timer y03. If the retry fails, trip with alarm $E-r\beta$ . If it succeeds, continue to run. 3: Continue to run	—	—	Y	Y	0	—
y03	(Timer)	0.0 to 60.0	0.1	s	Y	Y	2.0	—
y04	(Baud rate)	0: 2400 bps 1: 4800 bps 2: 9600 bps 3: 19200 bps 4: 38400 bps	—	—	Y	Y	3	—
y05	(Data length)	0: 8 bits 1: 7 bits	—	—	Y	Y	0	—
y06	(Parity check)	0: None (2 stop bits for Modbus RTU) 1: Even parity (1 stop bit for Modbus RTU) 2: Odd parity (1 stop bit for Modbus RTU) 3: None (1 stop bit for Modbus RTU)	—	—	Y	Y	0	—
y07	(Stop bits)	0: 2 bits 1: 1 bit	—	—	Y	Y	0	—
y08	(No-response error detection time)	0: No detection 1 to 60	1	s	Y	Y	0	—
y09	(Response interval)	0.00 to 1.00	0.01	s	Y	Y	0.01	—
y10	(Protocol selection)	0: Modbus RTU protocol 1: FRENIC Loader protocol (SX protocol) 2: Fuji general-purpose inverter protocol	—	—	Y	Y	1	—
y11	RS-485 Communication (Option) (Station address)	1 to 255	1	—	N	Y	1	—
y12	(Communications error processing)	0: Immediately trip with alarm $E-r\beta$ 1: Trip with alarm $E-r\beta$ after running for the period specified by timer y13 2: Retry during the period specified by timer y13. If the retry fails, trip with alarm $E-r\beta$ . If it succeeds, continue to run. 3: Continue to run	—	—	Y	Y	0	—
y13	(Timer)	0.0 to 60.0	0.1	s	Y	Y	2.0	—
y14	(Baud rate)	0: 2400 bps 1: 4800 bps 2: 9600 bps 3: 19200 bps 4: 38400 bps	—	—	Y	Y	3	—
y15	(Data length)	0: 8 bits 1: 7 bits	—	—	Y	Y	0	—
y16	(Parity check)	0: None (2 stop bits for Modbus RTU) 1: Even parity (1 stop bit for Modbus RTU) 2: Odd parity (1 stop bit for Modbus RTU) 3: None (1 stop bit for Modbus RTU)	—	—	Y	Y	0	—
y17	(Stop bits)	0: 2 bits 1: 1 bit	—	—	Y	Y	0	—
y18	(No-response error detection time)	0: No detection 1 to 60	1	s	Y	Y	0	—
y19	(Response interval)	0.00 to 1.00	0.01	s	Y	Y	0.01	—
y20	(Protocol selection)	0: Modbus RTU protocol 2: Fuji general-purpose inverter protocol	—	—	Y	Y	0	—
y98	Bus Link Function (Mode selection)	Frequency command Run command 0: Follow H30 data Follow H30 data 1: Via field bus option Via field bus option 2: Follow H30 data Via field bus option 3: Via field bus option Via field bus option	—	—	Y	Y	0	5-68
y99	Loader Link Function (Mode selection)	Frequency command Run command 0: Follow H30 and y98 data Follow H30 and y98 data 1: Via RS-485 link (Loader) Follow H30 and y98 data 2: Follow H30 and y98 data Via RS-485 link (Loader) 3: Via RS-485 link (Loader) Via RS-485 link (Loader)	—	—	Y	N	0	—

Table 5.1 (1) Factory Defaults According to Inverter Capacity

Power supply voltage	Nominal applied motor (HP)	Inverter type	Fuji's standard torque boost (%)	Rated capacity of motor (HP)	Restart mode after momentary power failure (Restart time) (s)
			F09/A05	P02/A16	H13
Three-phase 230 V	1/8	FRNF12E1■-2U	8.4	0.12	0.5
	1/4	FRNF25E1■-2U	8.4	0.25	0.5
	1/2	FRNF50E1■-2U	7.1	0.50	0.5
	1	FRN001E1■-2U	6.8	1.00	0.5
	2	FRN002E1■-2U	6.8	2.00	0.5
	3	FRN003E1■-2U	6.8	3.00	0.5
	5	FRN005E1■-2U	5.5	5.00	0.5
	7.5	FRN007E1■-2U	4.9	7.50	0.5
	10	FRN010E1■-2U	4.4	10.00	0.5
	15	FRN015E1■-2U	3.5	15.00	1.0
20	FRN020E1■-2U	2.8	20.00	1.0	
Three-phase 460 V	1/2	FRNF50E1■-4U	7.1	0.50	0.5
	1	FRN001E1■-4U	6.8	1.00	0.5
	2	FRN002E1■-4U	6.8	2.00	0.5
	3	FRN003E1■-4U	6.8	3.00	0.5
	5	FRN005E1■-4U	5.5	5.00	0.5
	7.5	FRN007E1■-4U	4.9	7.50	0.5
	10	FRN010E1■-4U	4.4	10.00	0.5
	15	FRN015E1■-4U	3.5	15.00	1.0
20	FRN020E1■-4U	2.8	20.00	1.0	
Single-phase 230 V	1/8	FRNF12E1■-7U	8.4	0.12	0.5
	1/4	FRNF25E1■-7U	8.4	0.25	0.5
	1/2	FRNF50E1■-7U	7.1	0.50	0.5
	1	FRN001E1■-7U	6.8	1.00	0.5
	2	FRN002E1■-7U	6.8	2.00	0.5
	3	FRN003E1■-7U	6.8	3.00	0.5

**Note 1)** A box (■) in the above table replaces S or E depending on the enclosure.









Table 5.1 (2) Factory Defaults According to Inverter Capacity

Power supply voltage	Nominal applied motor (HP)	Inverter type	Rated current of HP standard motor (A)
			F11/E34/E37/A07
Three-phase 230 V	1/8	FRNF12E1■-2U	0.68
	1/4	FRNF25E1■-2U	1.4
	1/2	FRNF50E1■-2U	2
	1	FRN001E1■-2U	3
	2	FRN002E1■-2U	5.8
	3	FRN003E1■-2U	7.9
	5	FRN005E1■-2U	12.6
	7.5	FRN007E1■-2U	18.6
	10	FRN010E1■-2U	25.3
	15	FRN015E1■-2U	37.3
20	FRN020E1■-2U	49.1	
Three-phase 460 V	1/2	FRNF50E1■-4U	1
	1	FRN001E1■-4U	1.5
	2	FRN002E1■-4U	2.9
	3	FRN003E1■-4U	4
	5	FRN005E1■-4U	6.3
	7.5	FRN007E1■-4U	9.3
	10	FRN010E1■-4U	12.7
	15	FRN015E1■-4U	18.7
20	FRN020E1■-4U	24.6	
Single-phase 230 V	1/8	FRNF12E1■-7U	0.68
	1/4	FRNF25E1■-7U	1.4
	1/2	FRNF50E1■-7U	2
	1	FRN001E1■-7U	3
	2	FRN002E1■-7U	5.8
	3	FRN003E1■-7U	7.9

**Note 1)** A box (■) in the above table replaces S or E depending on the enclosure.

### ■ Changing, validating, and saving function code data when the inverter is running

Function codes are indicated by the following based on whether they can be changed or not when the inverter is running:

Notation	Change when running	Validating and saving function code data
Y*	Possible	If the data of the codes marked with Y* is changed with  and  keys, the change will immediately take effect; however, the change is not saved into the inverter's memory. To save the change, press the  key. If you press the  key without pressing the  key to exit the current state, then the changed data will be discarded and the previous data will take effect for the inverter operation.
Y	Possible	Even if the data of the codes marked with Y is changed with  and  keys, the change will not take effect. Pressing the  key will make the change take effect and save it into the inverter's memory.
N	Impossible	—

### ■ Copying data

The data copying feature copies the function code data stored in the inverter's memory into the keypad's memory. With this feature, you can easily transfer the data saved in a source inverter to other destination inverters.

The standard keypad does not support this feature. The optional multi-function keypad supports it with Menu #8 in Programming mode.

If the specifications of the source and destination inverters differ, some code data may not be copied to ensure safe operation of your power system. Whether data will be copied or not is detailed with the following symbols in the "Data copying" column of the function code tables given below.

Y: Will be copied unconditionally.

Y1: Will not be copied if the rated capacity differs from the source inverter.

Y2: Will not be copied if the rated input voltage differs from the source inverter.

N: Will not be copied. (The function code marked with "N" is not subject to the Verify operation, either.)

If necessary, set up uncopied code data manually and individually.

### ■ Using negative logic for programmable I/O terminals

The negative logic signaling system can be used for the digital input and output terminals by setting the function code data specifying the properties for those terminals. Negative logic refers to the inverted ON/OFF (logical value 1 (true)/0 (false)) state of input or output signal. An active-ON signal (the function takes effect if the terminal is short-circuited.) in the normal logic system is functionally equivalent to active-OFF signal (the function takes effect if the terminal is opened.) in the negative logic system. An active-ON signal can be switched to active-OFF signal, and vice versa, with the function code data setting.

To set the negative logic system for an I/O terminal, enter data of 1000s (by adding 1000 to the data for the normal logic) in the corresponding function code. Some signals cannot switch to active-OFF depending upon their assigned functions.

Example: "Coast to a stop" command **BX** assigned to any of digital input terminals [X1] to [X5] using any of function codes E01 through E05

Function code data	<b>BX</b>
7	Turning <b>BX</b> ON causes the motor to coast to a stop. (Active ON)
1007	Turning <b>BX</b> OFF causes the motor to coast to a stop. (Active OFF)

## 5.2 Overview of Function Codes



This section provides an overview of the function codes frequently used for the FRENIC-Multi series of inverter.









 For details about the function codes given below and other function codes not given below, refer to the FRENIC-Multi User's Manual, Chapter 9 "FUNCTION CODES" and the RS-485 Communications User's Manual.



---





### F00 Data Protection

---

F00 specifies whether to protect function code data (except F00) and digital reference data (such as frequency command, PID command and timer operation) from accidentally getting changed by pressing the  /  keys.

Data for F00	Function
0	Disable both data protection and digital reference protection, allowing you to change both function code data and digital reference data with the  /  keys.
1	Enable data protection and disable digital reference protection, allowing you to change digital reference data with the  /  keys. But you cannot change function code data (except F00).
2	Disable data protection and enable digital reference protection, allowing you to change function code data with the  /  keys. But you cannot change digital reference data.
3	Enable both data protection and digital reference protection, not allowing you to change function code data or digital reference data with the  /  keys.

Enabling the protection disables the  /  keys to change function code data.

To change F00 data, simultaneous keying of  +  (from 0 to 1) or  +  (from 1 to 0) keys is required.

 Even when F00 = 1 or 3, function code data can be changed via the communications link.



For similar purposes, **WE-KP**, a signal enabling editing of function code data from the keypad is provided as a terminal command for digital input terminals. (Refer to the descriptions of E01 through E05.)

---

### F01, C30 Frequency Command 1 and 2

---

F01 or C30 sets the source that specifies reference frequency 1 or reference frequency 2, respectively.

Data for F01, C30	Function
0	Enable  /  keys on the keypad. (Refer to Chapter 3 "OPERATION USING THE KEYPAD.")
1	Enable the voltage input to terminal [12] (0 to ±10 VDC, maximum frequency obtained at ±10 VDC).

Data for F01, C30	Function
2	Enable the current input to terminal [C1] (C1 function) (+4 to +20 mA DC, maximum frequency obtained at +20 mA DC).
3	Enable the sum of voltage (0 to +10 VDC) and current inputs (+4 to +20 mA DC) given to terminals [12] and [C1] (C1 function), respectively. See the two items listed above for the setting range and the value required for maximum frequencies. Note: If the sum exceeds the maximum frequency (F03), the maximum frequency will apply.
5	Enable the voltage input to terminal [C1] (V2 function) (0 to +10 VDC, maximum frequency obtained at 10 VDC).
7	Enable <b>UP</b> and <b>DOWN</b> commands assigned to the digital input terminals. The <b>UP</b> command (data = 17) and <b>DOWN</b> command (data = 18) should be assigned to the digital input terminals [X1] to [X5].
11	Enable the digital input of the binary coded decimal (BCD) code or binary data entered via the digital I/O interface option. For details, refer to the Digital I/O Interface Option Instruction Manual.
12	Enable the pulse train entered via the PG interface card (option). For details, refer to the PG Interface Card Instruction Manual.









- To input bipolar analog voltage (0 to  $\pm 10$  VDC) to terminal [12], set function code C35 to "0." Setting C35 to "1" enables the voltage range from 0 to +10 VDC and interprets the negative polarity input from 0 to -10 VDC as 0 V.
- Terminal [C1] can be used for current input (C1 function) or voltage input (V2 function) depending upon the settings of switch SW7 on the interface PCB and function code E59.
- In addition to the frequency command sources described above, higher priority command sources including communications link and multi-frequency are provided.



Using the terminal command **H<sub>z2</sub>/H<sub>z1</sub>** assigned to one of the digital input terminals switches between frequency command 1 (F01) and frequency command 2 (C30). Refer to function codes E01 to E05.

F02 selects the source that specifies a run command for running the motor.

Data for F02	Run Command Source	Description
0	Keypad (Rotation direction specified by terminal command)	Enables the  /  keys to run and stop the motor. The rotation direction of the motor is specified by terminal command <b>FWD</b> or <b>REV</b> .
1	External signal	Enables terminal command <b>FWD</b> or <b>REV</b> to run and stop the motor.
2	Keypad (Forward rotation)	Enables  /  keys to run and stop the motor. Note that this run command enables only the forward rotation. There is no need to specify the rotation direction.
3	Keypad (Reverse rotation)	Enables  /  keys to run and stop the motor. Note that this run command enables only the reverse rotation. There is no need to specify the rotation direction.



- When function code F02 = 0 or 1, the "Run forward" **FWD** and "Run reverse" **REV** terminal commands must be assigned to terminals [FWD] and [REV], respectively.
- When the **FWD** or **REV** is ON, the F02 data cannot be changed.
- When assigning the **FWD** or **REV** to terminal [FWD] or [REV] with F02 being set to "1," be sure to turn the target terminal OFF beforehand; otherwise, the motor may unintentionally rotate.
- In addition to the run command sources described above, higher priority command sources including communications link are provided. For details, refer to the FRENIC-Multi User's Manual.

F03 specifies the maximum frequency to limit a reference frequency. Specifying the maximum frequency exceeding the rating of the equipment driven by the inverter may cause damage or a dangerous situation. Make sure that the maximum frequency setting matches the equipment rating.

## WARNING

The inverter can easily accept high-speed operation. When changing the speed setting, carefully check the specifications of motors or equipment beforehand.

**Otherwise injuries could occur.**



Modifying F03 data to allow a higher reference frequency requires also changing F15 data specifying a frequency limiter (high).

F04	Base Frequency 1
F05	Rated Voltage at Base Frequency 1
F06	Maximum Output Voltage 1
H50, H51	Non-linear V/f Pattern 1 (Frequency and Voltage)
H52, H53	Non-linear V/f Pattern 2 (Frequency and Voltage)

These function codes specify the base frequency and the voltage at the base frequency essentially required for running the motor properly. If combined with the related function codes H50 through H53, these function codes may profile the non-linear V/f pattern by specifying increase or decrease in voltage at any point on the V/f pattern.

The following description includes setups required for the non-linear V/f pattern.

At high frequencies, the motor impedance may increase, resulting in an insufficient output voltage and a decrease in output torque. This feature is used to increase the voltage with the maximum output voltage 1 to prevent this problem from happening. Note, however, that you cannot increase the output voltage beyond the voltage of the inverter's input power.

■ Base Frequency 1 (F04)

Set the rated frequency printed on the nameplate labeled on the motor.

■ Rated Voltage at Base Frequency (F05)

Set 0 or the rated voltage printed on the nameplate labeled on the motor.

- If 0 is set, the rated voltage at base frequency is determined by the power source of the inverter. The output voltage will vary in line with any variance in input voltage.
- If the data is set to anything other than 0, the inverter automatically keeps the output voltage constant in line with the setting. When any of the auto torque boost settings, auto energy saving or slip compensation is active, the voltage settings should be equal to the rated voltage of the motor.

■ Non-linear V/f Patterns 1 and 2 for Frequency (H50 and H52)

Set the frequency component at an arbitrary point of the non-linear V/f pattern.

(Setting 0.0 to H50 or H52 disables the non-linear V/f pattern operation.)

■ Non-linear V/f Patterns 1 and 2 for Voltage (H51 and H53)

Sets the voltage component at an arbitrary point of the non-linear V/f pattern.

■ Maximum Output Voltage (F06)

Set the voltage for the maximum frequency 1 (F03).



- If F05 (Rated Voltage at Base Frequency 1) is set to "0," settings of H50 through H53 and F06 do not take effect. (When the non-linear point is below the base frequency, the linear V/f pattern applies; when it is above, the output voltage is kept constant.)
- When the auto torque boost (F37) is enabled, the non-linear V/f pattern takes no effect.



Examples:

■ Normal (linear) V/f pattern

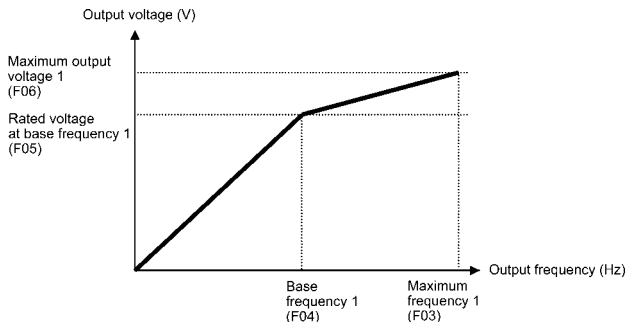

■ V/f pattern with two non-linear points

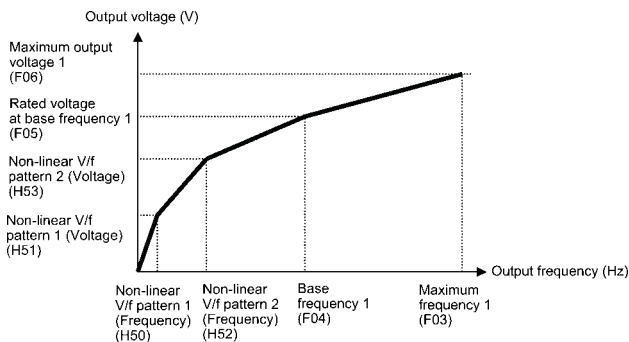



---

F07	Acceleration Time 1
F08	Deceleration Time 1
E10	Acceleration Time 2
E11	Deceleration Time 2

---

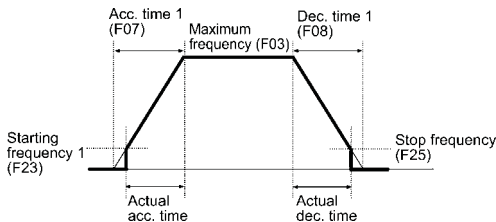
F07 specifies the acceleration time, the length of time the frequency increases from 0 Hz to the maximum frequency. F08 specifies the deceleration time, the length of time the frequency decreases from the maximum frequency down to 0 Hz.





- If you choose S-curve acceleration/deceleration or curvilinear acceleration/deceleration in Acceleration/Deceleration Pattern (H07), the actual acceleration/deceleration times are longer than the specified times. Refer to the description of H07 for details.

- Specifying an improperly short acceleration/deceleration time may activate the current limiter, torque limiter, or anti-regenerative control, resulting in a longer acceleration/deceleration time than the specified one.

- Acceleration time 1 (F07, F08) and deceleration time 1 (E10, E11) is switched by terminal command **RT1** assigned to any of the digital input terminals with any of function codes E01 through E05.



- Acceleration/deceleration time 1 (F07/F08) and acceleration/deceleration time 2 (E10/E11) are switched by terminal command **RT1** assigned to any of the digital input terminals with any of function codes E01 through E05.

F09  
F37

Torque Boost 1  
Load Selection/Auto Torque Boost/Auto Energy Saving Operation 1

F37 specifies V/f pattern, torque boost type, and auto energy saving operation for optimizing the operation in accordance with the characteristics of the load. F09 specifies the type of torque boost in order to provide sufficient starting torque.

Data for F37	V/f pattern	Torque boost (F09)	Auto energy saving	Applicable load
0	Variable torque V/f pattern	Torque boost specified by F09	Disable	Variable torque load (General purpose fans and pumps)
1				Constant torque load
2	Linear V/f pattern	Auto torque boost		Constant torque load (To be selected if a motor may be over-excited at no load.)
3	Variable torque V/f pattern	Torque boost specified by F09	Enable	Variable torque load (General purpose fans and pumps)
4				Constant torque load
5	Linear V/f pattern	Auto torque boost		Constant torque load (To be selected if a motor may be over-excited at no load.)

**Note:** If a required "load torque + acceleration torque" is more than 50% of the rated torque, it is recommended to select the linear V/f pattern (factory default).

#### ■ V/f characteristics

The FRENIC-Multi series of inverters offers a variety of V/f patterns and torque boosts, which include V/f patterns suitable for variable torque load such as general fans and pumps or for special pump load requiring high starting torque. Two types of torque boost are available: manual and automatic.

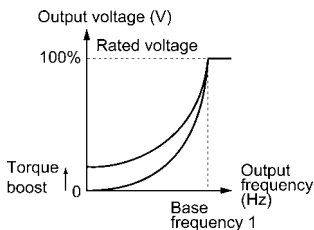

Variable torque V/f pattern (F37 = 0)

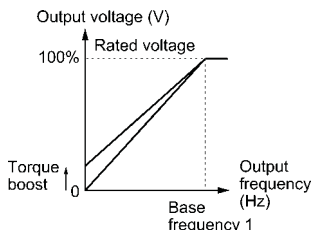

Linear V/f pattern (F37 = 1)



When the variable torque V/f pattern is selected (F37 = 0 or 3), the output voltage may be low and insufficient voltage output may result in less output torque of the motor at a low frequency zone, depending on some characteristics of the motor itself and load. In such a case, it is recommended to increase the output voltage at the low frequency zone using the non-linear V/f pattern.

Recommended value: H50 = 1/10 of the base frequency

H51 = 1/10 of the voltage at base frequency

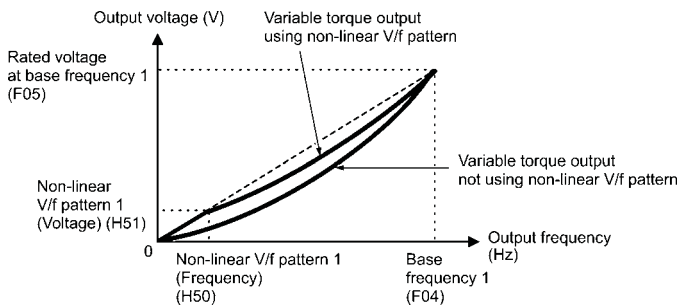

## ■ Torque boost

### • Manual torque boost (F09)

In torque boost using F09, constant voltage is added to the basic V/f pattern, regardless of the load, to give the output voltage. To secure a sufficient starting torque, manually adjust the output voltage to optimally match the motor and its load by using F09. Specify an appropriate level that guarantees smooth start-up and yet does not cause over-excitation with no or light load.

Torque boost per F09 ensures high driving stability since the output voltage remains constant regardless of the load fluctuation.

Specify the F09 data in percentage to the rated voltage at base frequency 1 (F05). At factory shipment, F09 is preset to a level that provides approx. 100% of starting torque.



Specifying a high torque boost level will generate a high torque, but may cause overcurrent due to over-excitation at no load. If you continue to drive the motor, it may overheat. To avoid such a situation, adjust torque boost to an appropriate level. When the non-linear V/f pattern and the torque boost are used together, the torque boost takes effect below the frequency on the non-linear V/f pattern's point.

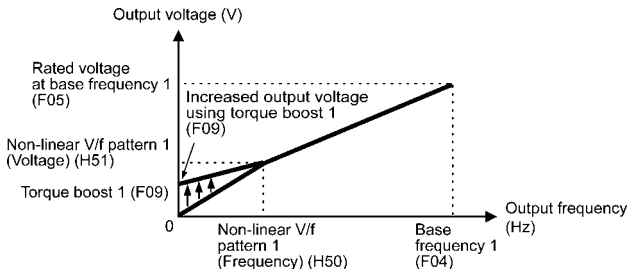

- Auto torque boost

This function automatically optimizes the output voltage to fit the motor with its load. Under light load, auto torque boost decreases the output voltage to prevent the motor from over-excitation. Under heavy load, it increases the output voltage to increase output torque of the motor.

- Note**
- Since this function relies also on the characteristics of the motor, set the base frequency 1 (F04), the rated voltage at base frequency 1 (F05), and other pertinent motor parameters (P01 through P03 and P06 through P99) in line with the motor capacity and characteristics, or else perform auto-tuning (P04).
  - When a special motor is driven or the load does not have sufficient rigidity, the maximum torque might decrease or the motor operation might become unstable. In such cases, do not use auto torque boost but choose manual torque boost per F09 (F37 = 0 or 1).

#### ■ Auto energy saving operation

This feature automatically controls the supply voltage to the motor to minimize the total power loss of motor and inverter. (Note that this feature may not be effective depending upon the motor or load characteristics. Check the advantage of energy saving before actually apply this feature to your power system.)

This feature applies to constant speed operation only. During acceleration/deceleration, the inverter will run with manual torque boost (F09) or auto torque boost, depending on the F37 data. If auto energy saving operation is enabled, the response to a change in motor speed may be slow. Do not use this feature for such a system that requires quick acceleration/deceleration.

- Note**
- Use auto energy saving only where the base frequency is 60 Hz or lower. If the base frequency is set at 60 Hz or higher, you may get a little or no energy saving advantage. The auto energy saving operation is designed for use with the frequency lower than the base frequency. If the frequency becomes higher than the base frequency, the auto energy saving operation will be invalid.
  - Since this function relies also on the characteristics of the motor, set the base frequency 1 (F04), the rated voltage at base frequency 1 (F05), and other pertinent motor parameters (P01 through P03 and P06 through P99) in line with the motor capacity and characteristics, or else perform auto-tuning (P04).

F10	Electronic Thermal Overload Protection for Motor 1 (Select motor characteristics)
F11	Electronic Thermal Overload Protection for Motor 1 (Overload detection level)
F12	Electronic Thermal Overload Protection for Motor 1 (Thermal time constant)

F10 through F12 specify the thermal characteristics of the motor for its electronic thermal overload protection that is used to detect overload conditions of the motor.

F10 selects the motor cooling mechanism to specify its characteristics, F11 specifies the overload detection current, and F12 specifies the thermal time constant.

- Note** Thermal characteristics of the motor specified by F10 and F12 are also used for the overload early warning. Even if you need only the overload early warning, set these characteristics data to these function codes. To disable the electronic thermal overload protection, set function code F11 to "0.00."

#### ■ Select motor characteristics (F10)

F10 selects the cooling mechanism of the motor-- shaft-driven or separately powered cooling fan.

Data for F10	Function
1	For a general-purpose motor with shaft-driven cooling fan (The cooling effect will decrease in low frequency operation.)
2	For an inverter-driven motor, non-ventilated motor, or motor with separately powered cooling fan (The cooling effect will be kept constant regardless of the output frequency.)

The figure below shows operating characteristics of the electronic thermal overload protection when F10 = 1. The characteristic factors  $\alpha_1$  through  $\alpha_3$  as well as their corresponding switching frequencies  $f_2$  and  $f_3$  vary with the characteristics of the motor. The tables below list the factors of the motor selected by P99 (Motor 1 Selection).

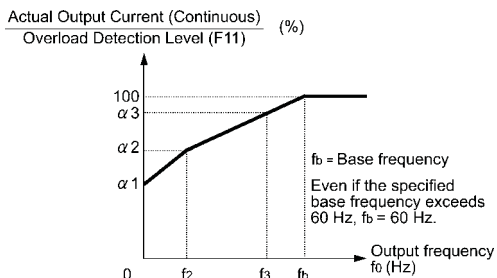

Cooling Characteristics of Motor with Shaft-driven Cooling Fan

Nominal Applied Motor and Characteristic Factors when P99 (Motor 1 selection) = 0 or 4

Nominal applied motor (HP)	Thermal time constant $\tau$ (Factory default)	Reference current for setting the thermal time constant ( $I_{max}$ )	Output frequency for motor characteristic factor		Characteristic factor (%)		
			$f_2$	$f_3$	$\alpha_1$	$\alpha_2$	$\alpha_3$
1/8 to 1	5 min	Allowable continuous current $\times 150\%$	5 Hz	7 Hz	75	85	100
2 to 5					85	85	100
7.5 to 15				6 Hz	90	95	100
20				7 Hz	85	85	100
25 to 30				5 Hz	92	100	100

Nominal Applied Motor and Characteristic Factors when P99 (Motor 1 Selection) = 1 or 3

Nominal applied motor (HP)	Thermal time constant $\tau$ (Factory default)	Reference current for setting the thermal time constant ( $I_{max}$ )	Output frequency for motor characteristic factor		Characteristic factor (%)		
			$f_2$	$f_3$	$\alpha_1$	$\alpha_2$	$\alpha_3$
1/8 to 30	5 min	Allowable continuous current $\times 150\%$	Base frequency $\times 33\%$	Base frequency $\times 33\%$	69	90	90

■ Overload detection level (F11)

F11 specifies the level at which the electronic thermal overload protection becomes activated.

In general, set F11 to the rated current of motor when driven at the base frequency (i.e. 1.0 to 1.1 multiple of the rated current of motor 1 (P03)). To disable the electronic thermal overload protection, set F11 to "0.00: Disable."

### ■ Thermal time constant (F12)

F12 specifies the thermal time constant of the motor. If the current of 150% of the overload detection level specified by F11 flows for the time specified by F12, the electronic thermal overload protection becomes activated to detect the motor overload. The thermal time constant for general-purpose motors including Fuji motors is approx. 5 minutes by factory default.

- Data setting range: 0.5 to 75.0 (minutes) in increments of 0.1 (minute)

(Example) When the F12 data is set at "5.0" (5 minutes)

As shown below, the electronic thermal overload protection is activated to detect an alarm condition (alarm code  $\overline{OL}$  /  $\overline{I}$ ) when the output current of 150% of the overload detection level (specified by F11) flows for 5 minutes, and 120% for approx. 12.5 minutes.

The actual driving time required for issuing a motor overload alarm tends to be shorter than the value specified as the time period from when the output current exceeds the rated current (100%) until it reaches 150% of the overload detection level.

Example of Operating Characteristics

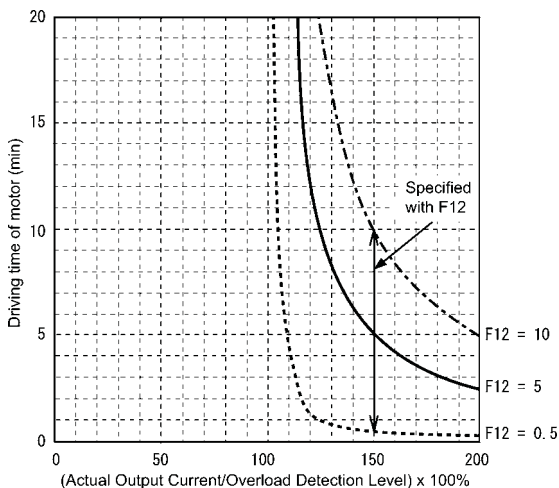

F14	Restart Mode after Momentary Power Failure
H13	Restart Mode after Momentary Power Failure, Restart time
H14	Restart Mode after Momentary Power Failure, Frequency fall rate
H16	Restart Mode after Momentary Power Failure, Allowable momentary power failure time

F14 specifies the action to be taken by the inverter such as trip and restart in the event of a momentary power failure.

■ Restart mode after momentary power failure (Mode selection) (F14)

Data for F14	Mode	Description
0	Disable restart (Trip immediately)	As soon as the DC link bus voltage drops below the undervoltage detection level due to a momentary power failure, the inverter issues undervoltage alarm $\underline{LL}$ and shuts down its output so that the motor enters a coast-to-stop state.
1	Disable restart (Trip after recovery from power failure)	As soon as the DC link bus voltage drops below the undervoltage detection level due to a momentary power failure, the inverter shuts down its output so that the motor enters a coast-to-stop state, but it does not enter the undervoltage state or issue undervoltage alarm $\underline{LL}$ .  The moment the power is restored, an undervoltage alarm $\underline{LL}$ is issued, while the motor remains in a coast-to-stop state.
4	Enable restart (Restart at the frequency at which the power failure occurred, for general loads)	As soon as the DC link bus voltage drops below the undervoltage detection level due to a momentary power failure, the inverter saves the output frequency being applied at that time and shuts down the output so that the motor enters a coast-to-stop state.  If a run command has been input, restoring power restarts the inverter at the output frequency saved during the last power failure processing.  This setting is ideal for applications with a moment of inertia large enough not to slow down the motor quickly, such as fans, even after the motor enters a coast-to-stop state upon occurrence of a momentary power failure.
5	Enable restart (Restart at the starting frequency, for low-inertia load)	After a momentary power failure, restoring power and then entering a run command restarts the inverter at the starting frequency specified by function code F23.  This setting is ideal for heavy load applications such as pumps, having a small moment of inertia, in which the motor speed quickly goes down to zero as soon as it enters a coast-to-stop state upon occurrence of a momentary power failure.



When the motor restarts after a momentary power failure, the auto search mode can apply, which detects the idling motor speed and runs the idling motor without stopping it. Refer to H09.

## ⚠ WARNING

If you enable the "Restart mode after momentary power failure" (Function code F14 = 4 or 5), the inverter automatically restarts the motor running when the power is restored. Design the machinery or equipment so that human safety is ensured after restarting.

**Otherwise an accident could occur.**

## Restart mode after momentary power failure (Basic operation)

The inverter recognizes a momentary power failure upon detecting the condition that DC link bus voltage goes below the undervoltage detection level, while the inverter is running. If the load of the motor is light and the duration of the momentary power failure is extremely short, the voltage drop may not be great enough for a momentary power failure to be recognized, and the motor may continue to run uninterrupted.

Upon recognizing a momentary power failure, the inverter enters the restart mode (after a recovery from momentary power failure) and prepares for restart. When power is restored, the inverter goes through an initial charging stage and enters the ready-to-run state. When a momentary power failure occurs, the power supply voltage for external circuits such as relay sequence circuits may also drop so as to turn the run command OFF. In consideration of such a situation, the inverter waits 2 seconds for a run command input after the inverter enters a ready-to-run state. If a run command is received within 2 seconds, the inverter begins the restart processing in accordance with the F14 data (Mode selection). If no run command has been received within 2-second wait period, the inverter cancels the restart mode (after a recovery from momentary power failure) and needs to be started again from the ordinary starting frequency. Therefore, ensure that a run command is entered within 2 seconds after a recovery of power, or install a mechanical latch relay.

When run commands are entered via the keypad, the above operation is also necessary for the mode (F02 = 0) in which the rotational direction is determined by the terminal command, **FWD** or **REV**. In the modes where the rotational direction is fixed (F02 = 2 or 3), it is retained inside the inverter so that the restart will begin as soon as the inverter enters the ready-to-run state.

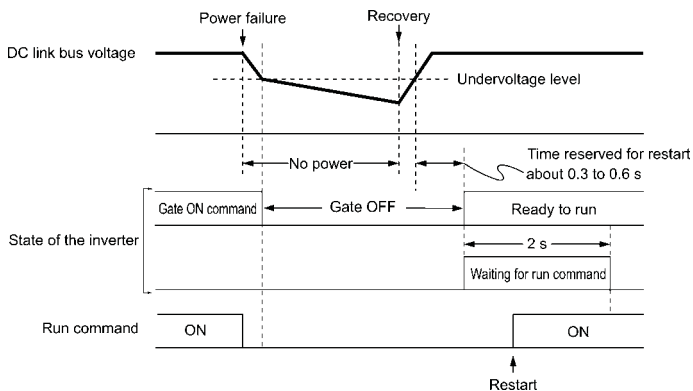

- When the power is restored, the inverter will wait 2 seconds for input of a run command. However, if the allowable momentary power failure time (H16) elapses after the power failure was recognized, even within the 2 seconds, the restart time for a run command is canceled. The inverter will start operation in the normal starting sequence.
- If the "Coast to a stop" terminal command **BX** is entered during the power failure, the inverter gets out of the restart mode and enters the normal running mode. If a run command is entered with power supply applied, the inverter will start from the normal starting frequency.



During a momentary power failure, the motor slows down. After power is restored, the inverter restarts at the frequency just before the momentary power failure. Then, the current limiting function works and the output frequency of the inverter automatically decreases. When the output frequency matches the motor speed, the motor accelerates up to the original output frequency. See the figure below. In this case, the instantaneous overcurrent limiting must be enabled (H12 = 1).

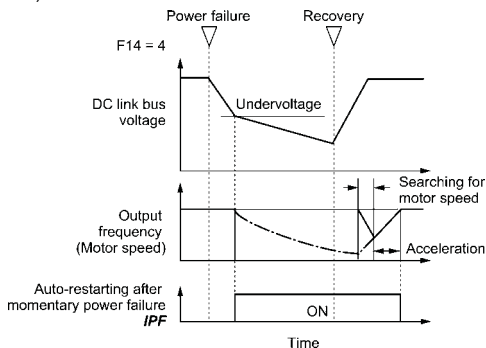

■ Restart mode after momentary power failure (Allowable momentary power failure time) (H16)

H16 specifies the maximum allowable duration (0.0 to 30.0 seconds) from an occurrence of a momentary power failure (undervoltage) until the inverter is to be restarted. Specify the coast-to-stop time during which the machine system and facility can be tolerated.

If the power is restored within the specified duration, the inverter restarts in the restart mode specified by F14. If the power is restored after the specified duration, the inverter recognizes that the power has been shut down so that it does not restart but starts (normal starting).

If H16 (Allowable momentary power failure time) is set to "999," restart will take place until the DC link bus voltage drops down to the allowable voltage for restart after a momentary power failure (50 V for 230 V class series and 100 V for 460 V class series). If the DC link bus voltage drops below the allowable voltage, the inverter recognizes that the power has been shut down so that it does not restart but starts (normal starting).

**Note** The time required from when the DC link bus voltage drops from the threshold of undervoltage until it reaches the allowable voltage for restart after a momentary power failure, greatly varies depending on the inverter capacity, the presence of options, and other factors.

■ Auto-restart after momentary power failure (Restart time) (H13)

H13 specifies the time period from momentary power failure occurrence until the inverter reacts for restarting process.

If the inverter starts the motor while motor's residual voltage is still in a high level, a large inrush current may flow or an overvoltage alarm may occur due to an occurrence of temporary regeneration. For safety, therefore, it is advisable to set H13 to a certain level so that restart will take place only after the residual voltage has dropped to a low level. Note that even when power is restored, restart will not take place until the restart time (H13) has elapsed.

Factory default

By factory default, H13 is set at one of the values shown below according to the inverter capacity. Basically, you do not need to change H13 data. However, if the long restart time causes the flow rate of the pump to overly decrease or causes any other problem, you might as well reduce the setting to about a half of the default value. In such a case, make sure that no alarm occurs.

Inverter capacity (HP)	Factory default of H13 (Restart time in seconds)
1/8 to 10	0.5
15 to 20	1.0

■ Restart after momentary power failure (Frequency fall rate) (H14)

During restart after a momentary power failure, if the inverter output frequency and the idling motor speed cannot be harmonized with each other, an overcurrent will flow, activating the overcurrent limiter. If it happens, the inverter reduces the output frequency to match the idling motor speed according to the reduction rate (Frequency fall rate: Hz/s) specified by H14.

Data for H14	Inverter's action for the output frequency fall
0.00	Follow the selected deceleration time
0.01 to 100.00 (Hz/s)	Follow data specified by H14
999	Follow the setting of the PI controller in the current limiter (of the current limit control block shown in FRENIC-Multi User's Manual, Chapter 4, Section 4.4, Figure 4.3.1 *). (The PI constant is prefixed inside the inverter.)



If the frequency fall rate is too high, regeneration may take place at the moment the motor rotation matches the inverter output frequency, causing an overvoltage trip. On the contrary, if the frequency fall rate is too low, the time required for the output frequency to match the motor speed (duration of current limiting action) may be prolonged, triggering the inverter overload prevention control.

---

**F15, F16** Frequency Limiter (High and Low)  
**H63** Low Limiter (Mode selection)

---

F15 and F16 specify the upper and lower limits of the output frequency, respectively.

H63 specifies the operation to be carried out when the reference frequency drops below the low level specified by F16, as follows:

- If H63 = 0, the output frequency will be held at the low level specified by F16.
- If H63 = 1, the inverter decelerates to stop the motor.



- When you change the frequency limiter (High) (F15) in order to raise the reference frequency, be sure to change the maximum frequency (F03/A01) accordingly.
- Maintain the following relationship among the data for frequency control:  
 $F15 > F16$ ,  $F15 > F23/A12$ , and  $F15 > F25$   
 $F03/A01 > F16$   
 where, F23/A12 is of the starting frequency and F25 is of the stop frequency.  
 If you specify any wrong data for these function codes, the inverter may not run the motor at the desired speed, or cannot start it normally.

F18	Bias (Frequency command 1)
C50	Bias (for Frequency 1) (Bias base point)
C32, C34	Analog Input Adjustment for [12] (Gain, Gain base point)
C37, C39	Analog Input Adjustment [C1] (Gain, Gain base point)
C42, C44	Analog Input Adjustment [V2] (Gain, Gain base point)

When any analog input for frequency command 1 (F01) is used, it is possible to define the relationship between the analog input and the reference frequency by multiplying the gain and adding the bias specified by F18.

As shown in the graph below, the relationship between the analog input and the reference frequency specified by frequency command 1 is determined by points "A" and "B." Point "A" is defined by the combination of the bias (F18) and its base point (C50); Point "B," by the combination of the gain (C32, C37 or C42) and its base point (C34, C39 or C44).

The combination of C32 and C34 applies to terminal [12], that of C37 and C39, to [C1] (C1 function), and that of C42 and C44, to [C1] (V2 function).

Configure the bias (F18) and gain (C32, C37 or C42), assuming the maximum frequency as 100%, and the bias base point (C50) and gain base point (C34, C39 or C44), assuming the full scale (10 VDC or 20 mA DC) of analog input as 100%.



- The analog input less than the bias base point (C50) is limited by the bias value (F18).
- Specifying that the data of the bias base point (C50) is equal to or greater than that of each gain base point (C34, C39 or C44) will be interpreted as invalid, so the inverter will reset the reference frequency to 0 Hz.

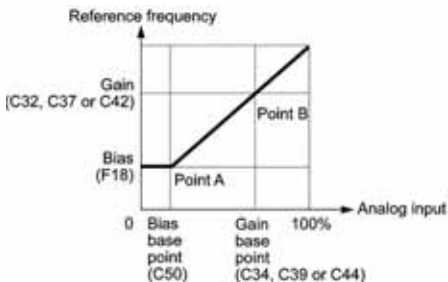

Example: Setting the bias, gain and their base points when the reference frequency 0 to 100% follows the analog input of 1 to 5 VDC to terminal [12] (in frequency command 1).

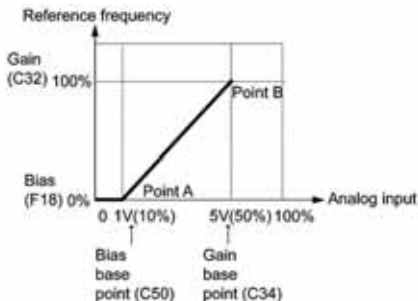

(Point A)

To set the reference frequency to 0 Hz for an analog input being at 1 V, set the bias to 0% (F18 = 0). Since 1 V is the bias base point and it is equal to 10% of 10 V (full scale), set the bias base point to 10% (C50 = 10).

(Point B)

To make the maximum frequency equal to the reference frequency for an analog input being at 5 V, set the gain to 100% (C32 = 100). Since 5 V is the gain base point and it is equal to 50% of 10 V (full scale), set the gain base point to 50% (C34 = 50).



The setting procedure for specifying a gain or bias alone without changing any base points is the same as that of Fuji conventional inverters of FRENIC5000G11S/P11S series, FVR-E11S series, etc.

F20 to F22	DC Braking 1 (Braking starting frequency, Braking level, and Braking time)
H95	DC Braking (Braking response mode)

F20 through F22 specify the DC braking that prevents motor 1 from running by inertia during decelerate-to-stop operation.

If the motor enters a decelerate-to-stop operation by turning OFF the run command or by decreasing the reference frequency below the stop frequency, the inverter activates the DC braking by flowing a current at the braking level (F21) during the braking time (F22) when the output frequency reaches the DC braking starting frequency (F20).

Setting the braking time to "0.0" (F22 = 0) disables the DC braking.

■ Braking starting frequency (F20)

F20 specifies the frequency at which the DC braking starts its operation during motor decelerate-to-stop state.

■ Braking level (F21)

F21 specifies the output current level to be applied when the DC braking is activated. The function code data should be set, assuming the rated output current of the inverter as 100%, in increments of 1%.

■ Braking time (F22)

F22 specifies the braking period that activates DC braking.

■ Braking response mode (H95)

H95 specifies the DC braking response mode.

Data for H95	Characteristics	Note
0	Slow response. Slows the rising edge of the current, thereby preventing reverse rotation at the start of DC braking.	Insufficient braking torque may result at the start of DC braking.
1	Quick response. Quickens the rising edge of the current, thereby accelerating the build-up of the braking torque.	Reverse rotation may result depending on the moment of inertia of the mechanical load and the coupling mechanism.



It is also possible to use an external digital input signal as an "Enable DC braking" terminal command **DCBRK**.

As long as the **DCBRK** command is ON, the inverter performs DC braking, regardless of the braking time specified by F22.

Turning the **DCBRK** command ON even when the inverter is in a stopped state activates DC braking. This feature allows the motor to be excited before starting, resulting in smoother acceleration (quicker build-up of acceleration torque).



In general, specify data of function code F20 at a value close to the rated slip frequency of motor. If you set it at an extremely high value, control may become unstable and an overvoltage alarm may result in some cases.

## ⚠ CAUTION

The DC brake function of the inverter does not provide any holding mechanism.  
**Injuries could occur.**

F23	Starting Frequency 1
F24	Starting Frequency 1 (Holding time)
F25	Stop Frequency
F39	Stop Frequency (Holding time)

At the startup of an inverter, the initial output frequency is equal to the starting frequency 1 specified by F23. The inverter stops its output when the output frequency reaches the stop frequency specified by F25.

Set the starting frequency to a level at which the motor can generate enough torque for startup. Generally, set the motor's rated slip frequency as the starting frequency.

In addition, F24 specifies the holding time for the starting frequency 1 in order to compensate for the delay time for the establishment of a magnetic flux in the motor. F39 specifies the holding time for the stop frequency in order to stabilize the motor speed at the stop of the motor.



If the starting frequency is lower than the stop frequency, the inverter will not output any power as long as the reference frequency does not exceed the stop frequency.

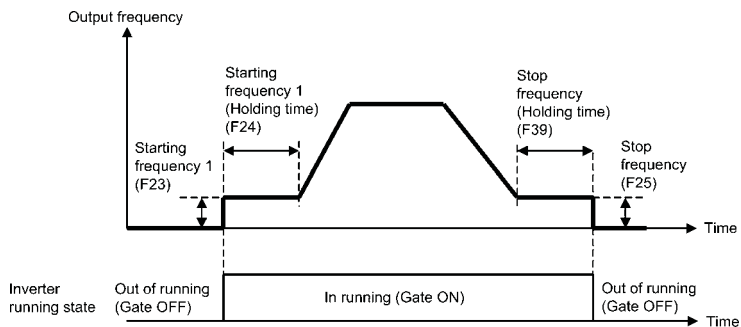

## F26, F27 Motor Sound (Carrier frequency and tone)

### ■ Motor sound (Carrier frequency) (F26)

F26 controls the carrier frequency so as to reduce an audible noise generated by the motor or electromagnetic noise from the inverter itself, and to decrease a leakage current from the main output (secondary) wirings.

Carrier frequency	0.75 to 15 kHz
Motor sound noise emission	High ↔ Low
Motor temperature (due to harmonics components)	High ↔ Low
Ripples in output current waveform	Large ↔ Small
Leakage current	Low ↔ High
Electromagnetic noise emission	Low ↔ High
Inverter loss	Low ↔ High



Specifying a too low carrier frequency will cause the output current waveform to have a large amount of ripples. As a result, the motor loss increases, causing the motor temperature to rise. Furthermore, the large amount of ripples tends to cause a current limiting alarm. When the carrier frequency is set to 1 kHz or below, therefore, reduce the load so that the inverter output current comes to be 80% or less of the rated current.

When a high carrier frequency is specified, the temperature of the inverter may rise due to an ambient temperature rise or an increase of the load. If it happens, the inverter automatically decreases the carrier frequency to prevent the inverter overload alarm *OLU*. With consideration for motor noise, the automatic reduction of carrier frequency can be disabled. Refer to the description of H98.

■ Motor sound (Tone) (F27)

F27 changes the motor running sound tone. This setting is effective when the carrier frequency set to function code F26 is 7 kHz or lower. Changing the tone level may reduce the high and harsh running noise from the motor.



If the sound level is set too high, the output current may become unstable, or mechanical vibration and noise may increase. Also, these function codes may not be very effective for certain types of motor.

F29 to F31 Analog Output [FM] (Mode selection, Voltage adjustment, Function)  
 F33 Analog Output [FM] (Pulse rate)

These function codes allow terminal [FM] to output monitored data such as the output frequency and the output current in an analog DC voltage or pulse (pulse duty: approximately 50%). The magnitude of such analog voltage or pulse rate is adjustable.

■ Mode selection (F29)

F29 specifies the property of the output to terminal [FM]. You need to set switch SW6 on the interface printed circuit board (PCB). Refer to Chapter 2 "Mounting and Wiring of the Inverter."

Data for F29	Output form	Position of slide switch SW6 mounted on the interface PCB
0	Voltage (0 to +10 VDC) ( <b>FMA</b> function)	FMA
2	Pulse (0 to 6000 p/s) ( <b>FMP</b> function)	FMP

■ Voltage adjustment (F30) dedicated to **FMA**

F30 allows you to adjust the output voltage or current representing the monitored data selected by F31 within the range of 0 to 300%.

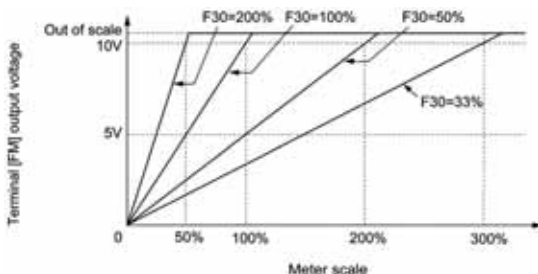

■ Function (F31)

F31 specifies what is output to analog output terminal [FM].

Data for F31	[FM] output	Function (Monitor the following)	Meter scale (Full scale at 100%)
0	Output frequency (before slip compensation)	Output frequency of the inverter (Equivalent to the motor synchronous speed)	Maximum frequency (F03/A01)
1	Output frequency (after slip compensation)	Output frequency of the inverter	Maximum frequency (F03/A01)
2	Output current	Output current (RMS) of the inverter	Twice the inverter rated current
3	Output voltage	Output voltage (RMS) of the inverter	250 V for 230 V class series, 500 V for 460 V class series
4	Output torque	Motor shaft torque	Twice the rated motor torque
5	Load factor	Load factor (Equivalent to the indication of the load meter)	Twice the rated motor load
6	Input power	Input power of the inverter	Twice the rated output of the inverter
7	PID feedback amount (PV)	Feedback amount under PID control	100% of the feedback amount
8	PG feedback value	Feedback value of closed loop control through the PG interface	Maximum speed (100% of the feedback value)
9	DC link bus voltage	DC link bus voltage of the inverter	500 V for 230 V class series, 1000 V for 460 V class series
10	Universal AO	Command via communications link (Refer to the RS-485 Communication User's Manual.)	20000 as 100%
13	Motor output	Motor output (kW)	Twice the rated motor output
14	Calibration	Full scale output of the meter calibration	This always outputs the full-scale (100%).
15	PID command (SV)	Command value under PID control	100% of the feedback amount
16	PID output (MV)	Output level of the PID controller under PID control (Frequency command)	Maximum frequency (F03/A01)



If F31 = 16 (PID output), J01 = 3 (Dancer control), and J62 = 2 or 3 (Ratio compensation enabled), the PID output is equivalent to the ratio against the primary reference frequency and may vary within  $\pm 300\%$  of the frequency. The monitor displays the PID output in a converted absolute value. To indicate the value up to the full-scale of 300%, set F30 data to "33" (%).

■ Pulse rate (F33) dedicated to **FMP**

F33 specifies the number of pulses at which the output of the monitored item selected reaches 100%, in accordance with the specifications of the counter to be connected.

F40, F41	Torque Limiter 1 (Limiting levels for driving and braking)
E16, E17	Torque Limiter 2 (Limiting levels for driving and braking)

If the inverter's output torque exceeds the specified levels of the driving torque limiter (F40/E16) and the braking torque limiter (F41/E17), the inverter controls the output frequency and limits the output torque for preventing a stall.

Specify the limiting levels at which the torque limiter becomes activated, as the percentage of the motor rated torque.



To switch the inverter's output torque limiter between torque limiter 1 (F40/F41) and torque limiter 2 (E16/E17), use the terminal command **TL2/TL1** assigned to a digital input terminal. (Refer to the descriptions of E01 to E05.)



The torque limiter and current limiter are very similar function each other. If both are activated concurrently, they may conflict each other and cause a hunting in the system. Avoid concurrent activation of these limiters.

**F42** Control Mode Selection 1  
**H68** Slip Compensation 1 (Operating conditions)

F42 specifies the control mode of the inverter to control a motor.

Data for F42	Control mode
0	V/f control with slip compensation inactive
1	Dynamic torque vector control
2	V/f control with slip compensation active
3	V/f control with optional PG interface
4	Dynamic torque vector control with optional PG interface

■ V/f control

In this control, the inverter controls a motor by the voltage and frequency according to the V/f pattern specified by function codes.

■ Slip compensation

Applying any load to an induction motor causes a rotational slip due to the motor characteristics, decreasing the motor rotation. The inverter's slip compensation facility first presumes the slip value of the motor based on the motor torque generated and raises the output frequency to compensate for the decrease in motor rotation. This prevents the motor from decreasing the rotation due to the slip.

That is, this facility is effective for improving the motor speed control accuracy.

The compensation value is specified by combination of function codes P12 (Rated slip frequency), P09 (Slip compensation gain for driving) and P11 (Slip compensation gain for braking).

H68 enables or disables the slip compensation facility according to the motor driving conditions.

Data for H68	Motor driving conditions		Motor driving frequency zone	
	Accl/Decel	Constant speed	Base frequency or below	Above the base frequency
0	Enable	Enable	Enable	Enable
1	Disable	Enable	Enable	Enable
2	Enable	Enable	Enable	Disable
3	Disable	Enable	Enable	Disable

■ Dynamic torque vector control

To get the maximal torque out of a motor, this control calculates the motor torque for the load applied and uses it to optimize the voltage and current vector output.

Selecting this control automatically enables the auto torque boost and slip compensation function and disables auto energy saving operation. Using the PG feedback speed control at same time, however, also disables the slip compensation function.

This control is effective for improving the system response against external disturbances and the motor speed control accuracy.

■ PG speed feedback control (PG interface)

This control is made available by mounting an optional pulse generator (PG) interface card. It uses the speed feedback from the PG on the motor shaft to control the motor speed with high accuracy.





In the slip compensation and dynamic torque vector control, the inverter uses the motor parameters to control its speed. Therefore, the following conditions should be satisfied; if not, the inverter may not get the proper performance from the motor.

- A single motor should be controlled. (It is difficult to apply this control to a group motor driving system.)
- Motor parameters P02, P03 and P06 to P12 are properly configured or they are fully auto-tuned.
- The rating of the motor to be controlled should be two ranks lower than that of the inverter. If not, the output current detection sensibility of the motor lowers, causing it difficult to accurately control the motor.
- The wiring between the inverter output and motor input terminals should not exceed 50 m in length. A long wiring run could not suppress the earth leakage current since the cable's electrostatic capacitance against the earth increases, causing it difficult to accurately control the motor speed.

## F43, F44 Current Limiter (Mode selection, Level)

When the output current of the inverter exceeds the level specified by the current limiter (F44), the inverter automatically manages its output frequency to prevent a stall and limit the output current. (Refer to the description of function code H12.)

If F43 = 1, the current limiter is enabled only during constant speed operation. If F43 = 2, the current limiter is enabled during both of acceleration and constant speed operation. Choose F43 = 1 if you need to run the inverter at full capability during acceleration and to limit the output current during constant speed operation.

### ■ Mode selection (F43)

F43 selects the motor running state in which the current limiter will be active.

Data for F43	Running states that enable the current limiter		
	During acceleration	During constant speed	During deceleration
0	Disable	Disable	Disable
1	Disable	Enable	Disable
2	Enable	Enable	Disable

### ■ Level (F44)

F44 specifies the operation level at which the output current limiter becomes activated, in ratio to the inverter rating.



- Since the current limit operation with F43 and F44 is performed by software, it may cause a delay in control. If you need a quick response, specify a current limit operation by hardware (H12 = 1) at the same time.
- If an excessive load is applied when the current limiter operation level is set extremely low, the inverter will rapidly lower its output frequency. This may cause an overvoltage trip or dangerous turnover of the motor rotation due to undershooting.
- The torque limiter and current limiter are very similar function each other. If both are activated concurrently, they may conflict each other and cause a hunting in the system. Avoid concurrent activation of these limiters.

## F50, F51 Electronic Thermal Overload Protection for Braking Resistor (Discharging capability and Allowable average loss)

These function codes specify the electronic thermal overload protection feature for the braking resistor.

Set F50 and F51 data to the discharging capability and allowable average loss, respectively. Those values differ depending on the specifications of the braking resistor, as listed on the following pages.



Depending on the thermal marginal characteristics of the braking resistor, the electronic thermal overload protection feature may act so that the inverter issues the overheat protection alarm  $d_{OH}$  even if the actual temperature rise is not enough. If it happens, review the relationship between the performance index of the braking resistor and settings of related function codes.

The table below lists the discharging capability and allowable average loss of the braking resistor. These values depend upon the inverter and braking resistor models.

## ■ External Braking Resistors

### Standard models

The thermal sensor relay mounted on the braking resistor acts as a thermal protector of the motor for overheat, so assign an "Enable external alarm trip" terminal command **THR** to any of digital input terminals [X1] to [X5], [FVD] and [REV] and connect that terminal and its common terminal to braking resistor's terminals 2 and 1.

To protect the motor from overheat without using the thermal sensor relay mounted on the braking resistor, configure the electronic thermal overload protection facility by setting F50 and F51 data to the discharging capability and allowable average loss values listed below, respectively.

Power supply voltage	Inverter type	Braking resistor		Resistance (Ω)	Continuous braking (100% braking torque)		Intermittent braking (Period: Less than 100s)	
		Type	Qty.		Discharging capability (kW)	Braking time (s)	Allowable average loss (kW)	Duty (%ED)
Three-phase 230 V	FRNF12E1 ■-2U	DB0.75-2	1	100	9	90	0.037	37
	FRNF25E1 ■-2U							
	FRNF50E1 ■-2U				45	0.044	22	
	FRN001E1 ■-2U					0.068	18	
	FRN002E1 ■-2U	DB2.2-2		40	34	30	0.075	10
	FRN003E1 ■-2U						0.077	7
	FRN005E1 ■-2U	DB3.7-2		33	37	20	0.093	5
	FRN007E1 ■-2U	DB5.5-2		20	55		0.138	
	FRN010E1 ■-2U	DB7.5-2		15	37	10	0.188	
	FRN015E1 ■-2U	DB11-2		10	55		0.275	
FRN020E1 ■-2U	DB15-2	8.6	75	0.375				
Three-phase 460 V	FRNF50E1 ■-4U	DB0.75-4	1	200	9	45	0.044	22
	FRN001E1 ■-4U							
	FRN002E1 ■-4U	DB2.2-4		160	34	30	0.075	10
	FRN003E1 ■-4U							
	FRN005E1 ■-4U	DB3.7-4		130	37	20	0.093	5
	FRN007E1 ■-4U	DB5.5-4		80	55			
	FRN010E1 ■-4U	DB7.5-4		60	38	10	0.188	
	FRN015E1 ■-4U	DB11-4		40	55			
	FRN020E1 ■-4U	DB15-4		34.4	75	0.375		
Single-phase 230 V	FRNF12E1 ■-7U	DB0.75-2	1	100	9	90	0.037	37
	FRNF25E1 ■-7U							
	FRNF50E1 ■-7U				45	0.044	22	
	FRN001E1 ■-7U					0.068	18	
	FRN002E1 ■-7U	DB2.2-2		40	34	30	0.075	10
FRN003E1 ■-7U	0.077		7					

**Note 1:** A box (■) in the above table replaces S or E depending on the enclosure.

### Compact models

When using the compact models of braking resistor TK80W120Ω or TK80W100Ω, set F50 to "7" and F51 to "0.033."

## 10% ED models

Power supply voltage	Inverter type	Braking resistor		Resistance ( $\Omega$ )	Continuous braking (100% braking torque)		Intermittent braking (Period: Less than 100 s)		
		Type	Qty.		Discharging capacity (kW)	Braking time (s)	Allowable average loss (kW)	Duty (%ED)	
Three-phase 230 V	FRNF12E1 ■-2U	DB0.75-2C	1	100	50	1000	0.075	100	
	FRNF25E1 ■-2U					500		75	
	FRNF50E1 ■-2U					250		37	
	FRN001E1 ■-2U					133		20	
	FRN002E1 ■-2U	DB2.2-2C		40	55	73	0.110	14	
	FRN003E1 ■-2U			50	10				
	FRN005E1 ■-2U	DB3.7-2C		33		140	75	0.185	
	FRN007E1 ■-2U	DB5.5-2C		20		55	20	0.275	
	FRN010E1 ■-2U	DB7.5-2C		15		37	10	0.375	
	FRN015E1 ■-2U	DB11-2C		10		55		0.55	
FRN020E1 ■-2U	DB15-2C	8.6	75	0.75					
Three-phase 460 V	FRNF50E1 ■-4U	DB0.75-4C	1	200		50	250	0.075	37
	FRN001E1 ■-4U						133		20
	FRN002E1 ■-4U	DB2.2-4C		160	55	73	0.110	14	
	FRN003E1 ■-4U			50	10				
	FRN005E1 ■-4U	DB3.7-4C		130		140	75	0.185	
	FRN007E1 ■-4U	DB5.5-4C		80		55	20	0.275	
	FRN010E1 ■-4U	DB7.5-4C		60		38	10	0.375	
	FRN015E1 ■-4U	DB11-4C		40		55		0.55	
	FRN020E1 ■-4U	DB15-4C		34.4		75		0.75	
	Single-phase 230 V	FRNF12E1 ■-7U		DB0.75-2C		1	100	50	1000
FRNF25E1 ■-7U		500	75						
FRNF50E1 ■-7U		250	37						
FRN001E1 ■-7U		133	20						
FRN002E1 ■-7U		DB2.2-2C	40	55	73		0.110	14	
FRN003E1 ■-7U			50	10					

**Note 1:** A box (■) in the above table replaces S or E depending on the enclosure.

E01 to E05, Terminal [X1] to [X5] Function  
E98, E99 Terminal [FWD] and [REV] Function

Function codes E01 to E05, E98 and E99 allow you to assign commands to terminals [X1] to [X5], [FWD], and [REV] which are general-purpose, programmable, digital input terminals.

These function codes may also switch the logic system between normal and negative to define how the inverter logic interprets either ON or OFF status of each terminal. The default setting is normal logic system "Active ON." So, explanations that follow are given in normal logic system "Active ON."

## ⚠ CAUTION

In the case of digital input, you can assign commands to the switching means for the run command and its operation and the reference frequency (e.g., **SS1, SS2, SS4, SS8, Hz2/Hz1, Hz/PID, IVS, and LE**). Be aware that switching any of such signals may cause a sudden start (running) or an abrupt change in speed.

**An accident or physical injury may result.**

Function code data		Terminal commands assigned	Symbol
Active ON	Active OFF		
0	1000	Select multi-frequency (0 to 15 steps)	<b>SS1</b>
1	1001		<b>SS2</b>
2	1002		<b>SS4</b>
3	1003		<b>SS8</b>
4	1004	Select ACC/DEC time	<b>RT1</b>
6	1006	Enable 3-wire operation	<b>HLD</b>
7	1007	Coast to a stop	<b>BX</b>
8	1008	Reset alarm	<b>RST</b>
9	1009	Enable external alarm trip	<b>THR</b>
10	1010	Ready for jogging	<b>JOG</b>
11	1011	Select frequency command 2/1	<b>Hz2/Hz1</b>
12	1012	Select motor 2 / motor 1	<b>M2/M1</b>
13	—	Enable DC braking	<b>DCBRK</b>
14	1014	Select torque limiter level	<b>TL2/TL1</b>
17	1017	UP (Increase output frequency)	<b>UP</b>
18	1018	DOWN (Decrease output frequency)	<b>DOWN</b>
19	1019	Enable data change with keypad	<b>WE-KP</b>
20	1020	Cancel PID control	<b>Hz/PID</b>
21	1021	Switch normal/inverse operation	<b>IVS</b>
24	1024	Enable communications link via RS-485 or field bus (option)	<b>LE</b>
25	1025	Universal DI	<b>U-DI</b>
26	1026	Enable auto search for idling motor speed at starting	<b>STM</b>
27	1027	Switch to speed feedback control	<b>PG/Hz *</b>
30	1030	Force to stop	<b>STOP</b>
33	1033	Reset PID integral and differential components	<b>PID-RST</b>
34	1034	Hold PID integral component	<b>PID-HLD</b>
42	1042	Activate the limit switch at start point	<b>LS *</b>
43	1043	Start/reset	<b>S/R *</b>
44	1044	Switch to the serial pulse receiving mode	<b>SPRM *</b>
45	1045	Enter the return mode	<b>RTN *</b>
46	1046	Enable overload stop	<b>OLS *</b>
98	—	Run forward (Exclusively assigned to [FWD] and [REV] terminals by E98 and E99)	<b>FWD</b>
99	—	Run reverse (Exclusively assigned to [FWD] and [REV] terminals by E98 and E99)	<b>REV</b>

 Any negative logic (Active OFF) command cannot be assigned to the functions marked with "—" in the "Active OFF" column.

The "Enable external alarm trip" and "Force to stop" are fail-safe terminal commands. For example, when data = 9 in "Enable external alarm trip," "Active OFF" (alarm is triggered when OFF); when data = 1009, "Active ON" (alarm is triggered when ON).

## Terminal function assignment and data setting

- Select multi-frequency (0 to 15 steps) -- **SS1**, **SS2**, **SS4**, and **SS8**  
(Function code data = 0, 1, 2, and 3)

The combination of the ON/OFF states of digital input signals **SS1**, **SS2**, **SS4** and **SS8** selects one of 16 different frequency commands defined beforehand by 15 function codes C05 to C19 (Multi-frequency 0 to 15). With this, the inverter can drive the motor at 16 different preset frequencies.

The table below lists the frequencies that can be obtained by the combination of switching **SS1**, **SS2**, **SS4** and **SS8**. In the "Selected frequency" column, "Other than multi-frequency" represents the reference frequency sourced by frequency command 1 (F01), frequency command 2 (C30), or others. For details, refer to the block diagram in FRENIC-Multi User's Manual, Chapter 4, Section 4.2 "Drive Frequency Command Block."

<b>SS8</b>	<b>SS4</b>	<b>SS2</b>	<b>SS1</b>	Selected frequency
OFF	OFF	OFF	OFF	Other than multi-frequency
OFF	OFF	OFF	ON	C05 (Multi-frequency 1)
OFF	OFF	ON	OFF	C06 (Multi-frequency 2)
OFF	OFF	ON	ON	C07 (Multi-frequency 3)
OFF	ON	OFF	OFF	C08 (Multi-frequency 4)
OFF	ON	OFF	ON	C09 (Multi-frequency 5)
OFF	ON	ON	OFF	C10 (Multi-frequency 6)
OFF	ON	ON	ON	C11 (Multi-frequency 7)
ON	OFF	OFF	OFF	C12 (Multi-frequency 8)
ON	OFF	OFF	ON	C13 (Multi-frequency 9)
ON	OFF	ON	OFF	C14 (Multi-frequency 10)
ON	OFF	ON	ON	C15 (Multi-frequency 11)
ON	ON	OFF	OFF	C16 (Multi-frequency 12)
ON	ON	OFF	ON	C17 (Multi-frequency 13)
ON	ON	ON	OFF	C18 (Multi-frequency 14)
ON	ON	ON	ON	C19 (Multi-frequency 15)

- Select ACC/DEC time -- **RT1** (Function code data = 4)

This terminal command switches between ACC/DEC time 1 (F07/F08) and ACC/DEC time 2 (E10/E11).

If no **RT1** command is assigned, ACC/DEC time 1 (F07/F08) takes effect by default.

Input terminal command <b>RT1</b>	Acceleration/deceleration time
OFF	Acceleration/deceleration time 1 (F07/F08)
ON	Acceleration/deceleration time 2 (E10/E11)

- Enable 3-wire operation -- **HLD** (Function code data = 6)

Turning this terminal command ON self-holds the forward **FWD** or reverse **REV** run command issued with it, to enable 3-wire inverter operation.

Short-circuiting the terminals between **HLD** and [CM] (i.e., when **HLD** is ON) self-holds the first **FWD** or **REV** command at its leading edge. Turning **HLD** OFF releases the self-holding.

When **HLD** is not assigned, 2-wire operation involving only **FWD** and **REV** takes effect.

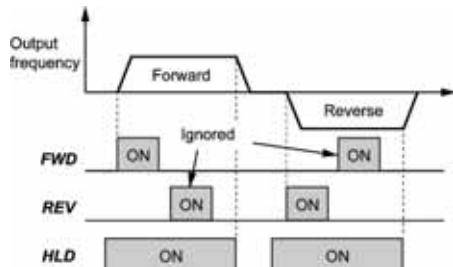

- Coast to a stop -- **BX** (Function code data = 7)

Turning this terminal command ON immediately shuts down the inverter output so that the motor coasts to a stop without issuing any alarms.

- Reset alarm -- **RST** (Function code data = 8)

Turning this terminal command ON clears the **ALM** state—alarm output (for any fault). Turning it OFF erases the alarm display and clears the alarm hold state.

When you turn the **RST** command ON, keep it ON for 10 ms or more. This command should be kept OFF for the normal inverter operation.

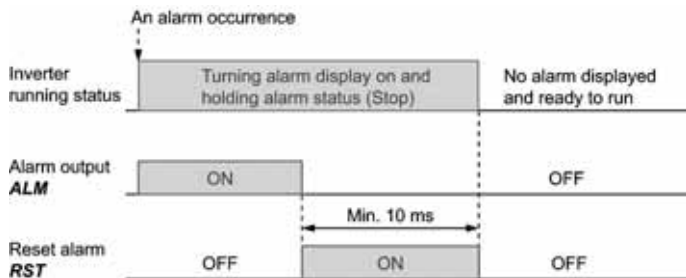

- Enable external alarm trip -- **THR** (Function code data = 9)

Turning this terminal command OFF immediately shuts down the inverter output (so that the motor coasts to a stop), displays the alarm **OH2**, and outputs the alarm relay (for any fault) **ALM**. The **THR** command is self-held, and is reset when an alarm reset takes place.





Use this alarm trip command from external equipment when you have to immediately shut down the inverter output in the event of an abnormal situation in a peripheral equipment.



■ Ready for jogging -- **JOG** (Function code data = 10)

This terminal command is used to jog or inch the motor for positioning a work piece.



Turning this command ON makes the inverter ready for jogging.

Simultaneous keying  +  keys on the keypad is functionally equivalent to this command; however, it is restricted by the run command source as listed below.

When the run command source is the keypad (F02 = 0, 2 or 3):



Input terminal command <b>JOG</b>	 +  keys on the keypad	Inverter running state
ON	—	Ready for jogging
OFF	Pressing these keys toggles between the "normal operation" and "ready for jogging."	Normal operation
		Ready for jogging

When the run command source is digital input (F02 = 1):

Input terminal command <b>JOG</b>	 +  keys on the keypad	Inverter running state
ON	Disable	Ready for jogging
OFF		Normal operation

### Jogging operation

Pressing the  key or turning the **FWD** or **REV** terminal command ON starts jogging.

For the jogging by the keypad, the inverter jogs only when the  key is held down. Releasing the  key decelerates to stop.

During jogging, the frequency specified by C20 (Jogging Frequency) and the acceleration/deceleration time specified by H54 (ACC/DEC Time) apply.



- The inverter's status transition between "ready for jogging" and "normal operation" is possible only when the inverter is stopped.
- To start jogging operation with the **JOG** terminal command and a run command (e.g., **FWD**), the input of the **JOG** should not be delayed 100 ms or more from that of the run command. If the delay exceeds 100 ms, the inverter does not jog the motor but runs it ordinarily until the next input of the **JOG**.

■ Select frequency command 2/1 -- **H<sub>z2</sub>/H<sub>z1</sub>** (Function code data = 11)

Turning this terminal command ON and OFF switches the frequency command source between frequency command 1 (F01) and frequency command 2 (C30).

If no **H<sub>z2</sub>/H<sub>z1</sub>** terminal command is assigned, the frequency sourced by F01 takes effect by default.

Input terminal command <b>H<sub>z2</sub>/H<sub>z1</sub></b>	Frequency command source
OFF	Follow F01 (Frequency command 1)
ON	Follow C30 (Frequency command 2)

- Select motor 2 / motor 1 -- **M2/M1** (Function code data = 12)

Turning this terminal command ON switches from motor 1 to motor 2. Switching is possible only when the inverter is stopped. Upon completion of switching, the digital terminal output "Switched to motor 2" **SWM2** (assigned to any of terminals [Y1], [Y2] and [30A/B/C]) turns ON.

If no **M2/M1** terminal command is assigned, motor 1 is selected by default.

Input terminal command <b>M2/M1</b>	Selected motor	<b>SWM2</b> status after completion of switching
OFF	Motor 1	OFF
ON	Motor 2	ON

Switching between motors 1 and 2 automatically switches applicable function codes as listed below. The inverter runs the motor with those codes that should be properly configured.

Function code name	For Motor 1	For Motor 2
Maximum Frequency	F03	A01
Base Frequency	F04	A02
Rated voltage at Base Frequency	F05	A03
Maximum Output Voltage	F06	A04
Torque Boost	F09	A05
Electronic Thermal Overload Protection for Motor (Select motor characteristics) (Overload detection level) (Thermal time constant)	F10 F11 F12	A06 A07 A08
DC Braking (Braking starting frequency) (Braking level) (Braking time)	F20 F21 F22	A09 A10 A11
Starting Frequency	F23	A12
Load Selection/Auto Torque Boost/Auto Energy Saving Operation	F37	A13
Control Mode Selection	F42	A14
Motor (No. of poles) (Rated capacity) (Rated current) (Auto-tuning) (Online tuning) (No-load current) (%R1) (%X) (Slip compensation gain for driving) (Slip compensation response time) (Slip compensation gain for braking) (Rated slip frequency)	P01 P02 P03 P04 P05 P06 P07 P08 P09 P10 P11 P12	A15 A16 A17 A18 A19 A20 A21 A22 A23 A24 A25 A26
Motor Selection	P99	A39
Slip Compensation(Operating conditions)	H68	A40
Output Current Fluctuation Damping Gain for Motor	H80	A41
Cumulative Motor Run Time	H94	A45
Startup Times of Motor	H44	A46



Motor 2 imposes functional restrictions on the following function codes. Confirm the settings of those function codes before use.

Functions	Restrictions	Related function codes
Non-linear V/f pattern	Disabled. Linear V/f pattern only	H50 to H53
Starting frequency	Starting frequency holding time not supported.	F24
Stop frequency	Stop frequency holding time not supported.	F39
Overload early warning	Disabled.	E34 and E35
Droop control	Disabled.	H28
<b>UP/DOWN</b> control	Disabled. Fixed at default setting 0.	H61
PID control	Disabled.	J01
Braking signal	Disabled.	J68 to J72
Software current limiter	Disabled.	F43 and F44
Rotation direction limitation	Disabled.	H08
Overload stop	Disabled.	J63 to J67

 **Note** To run motor 2 with the **M2/M1** terminal command and a run command (e.g., **FWD**), the input of the **M2/M1** should not be delayed 10 ms or more from that of the run command. If the delay exceeds 10 ms, motor 1 will be driven by default.

- Enable DC braking -- **DCBRK** (Function code data = 13)

This terminal command gives the inverter a DC braking command through the inverter's digital input.

(Refer to the descriptions of F20 to F22 for DC braking.)

- Select torque limiter level -- **TL2/TL1** (Function code data = 14)

This terminal command switches between torque limiter 1 (F40 and F41) and torque limiter 2 (E16 and E17) as listed below.

If no **TL2/TL1** terminal command is assigned, torque limiter 1 (F40 and F41) takes effect by default.

Input terminal command <b>TL2/TL1</b>	Torque limiter level
OFF	Torque limiter 1 (F40 and F41)
ON	Torque limiter 2 (E16 and E17)

- UP (Increase output frequency) and DOWN (Decrease output frequency) commands -- **UP** and **DOWN** (Function code data = 17, 18)

- Frequency setting

When the **UP/DOWN** control is selected for frequency setting with a run command ON, turning the **UP** or **DOWN** terminal command ON causes the output frequency to increase or decrease, respectively, within the range from 0 Hz to the maximum frequency as listed below.

<b>UP</b>	<b>DOWN</b>	Function
Data = 17	Data = 18	
OFF	OFF	Keep the current output frequency.
ON	OFF	Increase the output frequency with the acceleration time currently specified.
OFF	ON	Decrease the output frequency with the deceleration time currently specified.
ON	ON	Keep the current output frequency.

The **UP/DOWN** control is available in two modes—one mode (H61 = 0) in which the initial value of the reference frequency is fixed to "0.00" at the start of the **UP/DOWN** control and the other mode (H61 = 1) in which the reference frequency applied in the previous **UP/DOWN** control applies as the initial value.

When H61 = 0, the reference frequency applied by the previous **UP/DOWN** control has been cleared to "0," so at the next restart (including powering on), use the **UP** terminal command to accelerate the speed as needed.

When H61 = 1, the inverter internally holds the current output frequency set by the **UP/DOWN** control and applies the held frequency at the next restart (including powering on).

**Note** At the time of restart, if an **UP** or **DOWN** terminal command is entered before the internal frequency reaches the output frequency saved in the memory, the inverter saves the current output frequency into the memory and starts the **UP/DOWN** control with the new frequency. The previous frequency held will be overwritten by the current one.

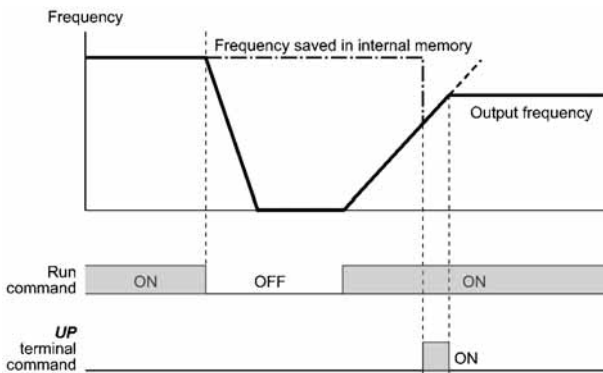

#### Initial frequency for the **UP/DOWN** control when the frequency command source is switched

When the frequency command source is switched to the **UP/DOWN** control from other sources, the initial frequency for the **UP/DOWN** control is as listed below:

Frequency command source	Switching command	Initial frequency for <b>UP/DOWN</b> control	
		H61 = 0	H61 = 1
Other than <b>UP/DOWN</b> (F01, C30)	Select frequency command 2/1 ( <b>Hz2/Hz1</b> )	Reference frequency given by the frequency command source used just before switching	
PID conditioner	Cancel PID control ( <b>Hz/PID</b> )	Reference frequency given by PID control (PID controller output)	
Multi-frequency	Select multi-frequency ( <b>SS1, SS2, SS4</b> and <b>SS8</b> )	Reference frequency given by the frequency command source used just before switching	Reference frequency at the time of previous <b>UP/DOWN</b> control
Communications link	Enable communications link via RS-485 or field bus ( <b>LE</b> )		

**Note** To enable the **UP** and **DOWN** terminal commands, you need to set frequency command 1 (F01) or frequency command 2 (C30) to "7" beforehand.

- Enable communications link via RS-485 or field bus (option) -- **LE**  
(Function code data = 24)

Turning this terminal command ON assigns priorities to frequency commands or run commands received via the RS-485 communications link (H30) or the field bus option (y98). No **LE** assignment is functionally equivalent to the **LE** being ON. (Refer to H30 (Communications link function) and y98 (Bus link function).)

- Enable auto search for idling motor speed at starting -- **STM**  
(Function code data = 26)

This digital terminal command determines, at the start of operation, whether or not to search for idling motor speed and follow it. Refer to H09 (Starting mode).

- Force to stop -- **STOP** (Function code data = 30)

Turning this terminal command OFF causes the motor to decelerate to a stop in accordance with the H56 data (Deceleration time for forced stop). After the motor stops, the inverter enters the alarm state with the alarm  $\mathcal{E}r\mathcal{E}$  displayed.

- Run forward -- **FWD** (Function code data = 98)

Turning this terminal command ON runs the motor in the forward direction; turning it OFF decelerates it to stop.

 This terminal command can be assigned only by E98 or E99.

- Run reverse -- **REV** (Function code data = 99)

Turning this terminal command ON runs the motor in the reverse direction; turning it OFF decelerates it to stop.

 This terminal command can be assigned only by E98 or E99.

---

E20, E21	Terminal [Y1] and [Y2] Function
E27	Terminal [30A/B/C] Function (Relay output)

---

E20, E21, and E27 assign output signals (listed on the next page) to general-purpose, programmable output terminals [Y1], [Y2], and [30A/B/C]. These function codes can also switch the logic system between normal and negative to define the property of those output terminals so that the inverter logic can interpret either the ON or OFF status of each terminal as active. The factory default settings are "Active ON."

Terminals [Y1] and [Y2] are transistor outputs and terminals [30A/B/C] are relay contact outputs. In normal logic, if an alarm occurs, the relay will be energized so that [30A] and [30C] will be closed, and [30B] and [30C] opened. In negative logic, the relay will be deenergized so that [30A] and [30C] will be opened, and [30B] and [30C] closed. This may be useful for the implementation of failsafe power systems.



- When a negative logic is employed, all output signals are active (e.g. an alarm would be recognized) while the inverter is powered OFF. To avoid causing system malfunctions by this, interlock these signals to keep them ON using an external power supply. Furthermore, the validity of these output signals is not guaranteed for approximately 1.5 seconds after power-on, so introduce such a mechanism that masks them during the transient period.
- Terminals [30A/B/C] use mechanical contacts that cannot stand frequent ON/OFF switching. Where frequent ON/OFF switching is anticipated (for example, limiting a current by using signals subjected to inverter output limit control such as switching to commercial power line), use transistor outputs [Y1] and [Y2] instead. The service life of a relay is approximately 200,000 times if it is switched ON and OFF at one-second intervals.

The table below lists functions that can be assigned to terminals [Y1], [Y2], and [30A/B/C]. To make the explanations simpler, the examples shown below are all written for the normal logic (Active ON).

Function code data		Functions assigned	Symbol
Active ON	Active OFF		
0	1000	Inverter running	<b>RUN</b>
1	1001	Frequency arrival signal	<b>FAR</b>
2	1002	Frequency detected	<b>FDT</b>
3	1003	Undervoltage detected (Inverter stopped)	<b>LU</b>
4	1004	Torque polarity detected	<b>B/D</b>
5	1005	Inverter output limiting	<b>IOL</b>
6	1006	Auto-restarting after momentary power failure	<b>IPF</b>
7	1007	Motor overload early warning	<b>OL</b>
10	1010	Inverter ready to run	<b>RDY</b>
21	1021	Frequency arrival signal 2	<b>FAR2</b>
22	1022	Inverter output limiting with delay	<b>IOL2</b>
26	1026	Auto-resetting	<b>TRY</b>
27	1027	Universal DO	<b>U-DO</b> *1
28	1028	Heat sink overheat early warning	<b>OH</b>
30	1030	Service lifetime alarm	<b>LIFE</b>
33	1033	Reference loss detected	<b>REF OFF</b>
35	1035	Inverter output on	<b>RUN2</b>
36	1036	Overload prevention control	<b>OLP</b>
37	1037	Current detected	<b>ID</b>
38	1038	Current detected 2	<b>ID2</b>
42	1042	PID alarm	<b>PID-ALM</b>
49	1049	Switched to motor 2	<b>SWM2</b>
56	1056	Motor overheat detected by thermistor (PTC)	<b>THM</b> *1
57	1057	Brake signal	<b>BRKS</b>
59	1059	Terminal [C1] wire break	<b>C1OFF</b> *1
76	1076	PG error detected	<b>PG-ERR</b> *2
80	1080	Stop position override alarm	<b>OT</b> *2
81	1081	Timer output	<b>TO</b> *2
82	1082	Positioning completed	<b>PSET</b> *2
83	1083	Current position count overflowed	<b>POF</b> *2
99	1099	Alarm output (for any alarm)	<b>ALM</b>

■ Inverter running -- **RUN** (Function code data = 0)

This output signal tells the external equipment that the inverter is running at a starting frequency or higher. It comes ON when the output frequency exceeds the starting frequency, and it goes OFF when it is less than the stop frequency. It is also OFF when the DC braking is in operation.

If this signal is assigned in negative logic (Active OFF), it can be used as a signal indicating "Inverter being stopped."

■ Frequency arrival signal -- **FAR** (Function code data = 1)

This output signal comes ON when the difference between the output frequency and reference frequency comes within the frequency arrival hysteresis width specified by E30. (Refer to the description of E30.)

■ Frequency detected -- **FDT** (Function code data = 2)

This output signal comes ON when the output frequency exceeds the frequency detection level specified by E31, and it goes OFF when the output frequency drops below the "Frequency detection level (E31) - Hysteresis width (E32)."

■ Undervoltage detected -- **LU** (Function code data = 3)

This output signal comes ON when the DC link bus voltage of the inverter drops below the specified undervoltage level, and it goes OFF when the voltage exceeds the level.

This signal is ON also when the undervoltage protective function is activated so that the motor is in an abnormal stop state (e.g., tripped).

When this signal is ON, a run command is disabled if given.

■ Torque polarity detected -- **B/D** (Function code data = 4)

The inverter detects the polarity of the internally calculated torque and issues the driving or braking polarity signal to this digital output. This signal comes OFF when the calculated torque is the driving one, and it goes ON when it is the braking one.

■ Inverter output limiting -- **IOL** (Function code data = 5)

This output signal comes ON when the inverter is limiting the output frequency by activating any of the following actions (minimum width of the output signal: 100 ms).

- Torque limiting (F40, F41, E16 and E17)
- Current limiting by software (F43 and F44)
- Instantaneous overcurrent limiting by hardware (H12 = 1)
- Automatic deceleration (Anti-regenerative control) (H69 = 2 or 4)
- Overload stop (Hit and stop) (J65 = 3)



When the **IOL** signal is ON, it may mean that the output frequency may have deviated from the frequency specified by the frequency command because of this limiting function.

■ Auto-restarting after momentary power failure -- **IPF** (Function code data = 6)

This output signal is ON either during continuous running after a momentary power failure or during the period from when the inverter has detected an undervoltage condition and shut down the output until restart has been completed (the output has reached the reference frequency).

To enable this **IPF** signal, set F14 (Restart mode after momentary power failure) to "4: Enable restart (Restart at the frequency at which the power failure occurred)" or "5: Enable restart (Restart at the starting frequency)" beforehand.

■ Motor overload early warning -- **OL** (Function code data = 7)

This output signal is used to issue a motor overload early warning that enables you to take an corrective action before the inverter detects a motor overload alarm  $\overline{OL}$  and shuts down its output. (Refer to the description of E34.)

■ Inverter ready to run -- **RDY** (Function code data = 10)

This output signal comes ON when the inverter becomes ready to run by completing hardware preparation (such as initial charging of DC link bus capacitors and initialization of the control circuit) and no protective functions are activated.

■ Frequency arrival signal 2 -- **FAR2** (Function code data = 21)

This output signal comes ON when a difference between the output frequency before the torque limiting and the reference frequency comes to within the frequency arrival hysteresis width (E30) and then the frequency arrival delay time (E29) has elapsed. (Refer to the descriptions of E29 and E30.)

■ Inverter output limiting with delay -- **IO L2** (Function code data = 22)

If the inverter enters any output limiting operation such as output torque limiting, output current limiting, automatic deceleration (anti-regenerative control), or overload stop (hit and stop), it automatically activates the stall-free facility and shifts the output frequency. When such an output limiting operation continues for 20 ms or more, this output signal comes ON.

This signal is used for lessening the load or alerting the user to an overload status with the monitor.

■ Heat sink overheat early warning -- **OH** (Function code data = 28)

This output signal is used to issue a heat sink overheat early warning that enables you to take a corrective action before an overheat trip  $\overline{OH}$  actually happens.

This signal comes ON when the temperature of the heat sink exceeds the "overheat trip  $\overline{OH}$  / temperature minus 5°C," and it goes OFF when it drops down to the "overheat trip  $\overline{OH}$  / temperature minus 8°C."

■ Service lifetime alarm -- **LIFE** (Function code data = 30)

This output signal comes ON when it is judged that the service life of any one of capacitors (DC link bus capacitors and electrolytic capacitors on the printed circuit board) and cooling fan has expired.

This signal should be used as a guide for replacement of the capacitors and cooling fan. If this signal comes ON, use the specified maintenance procedure to check the service life of these parts and determine whether the parts should be replaced or not.

■ Reference loss detected -- **REF OFF** (Function code data = 33)

This output signal comes ON when an analog input used as a frequency command source is in a reference loss state (as specified by E65) due to a wire break or a weak connection. This signal goes OFF when the operation under the analog input is resumed. (Refer to the description of E65.)

■ Inverter output on -- **RUN2** (Function code data = 35)

This output signal comes ON when the inverter is running at the starting frequency or below or the DC braking is in operation.

■ Overload prevention control -- **OLP** (Function code data = 36)

This output signal comes ON when the overload prevention control is activated. The minimum ON-duration is 100 ms. (Refer to the description of H70.)

■ Current detected and Current detected 2 -- **ID** and **ID2** (Function code data = 37, 38)

The **ID** or **ID2** output signal comes ON when the output current of the inverter exceeds the level specified by E34 (Current detection (Level)) or E37 (Current detection 2 (Level)) for the time longer than the one specified by E35 (Current detection (Timer)) or E38 (Current detection 2 (Timer)), respectively. The minimum ON-duration is 100 ms.

The **ID** or **ID2** goes OFF when the output current drops below 90% of the rated operation level.

These two output signals can be assigned to two different digital output terminals independently if necessary.



Function code E34 is effective for not only the motor overload early warning **OL**, but also for the operation level of the current detection **ID**. (Refer to the description of E34.)

■ Switched to motor 2 -- **SWM2** (Function code data = 49)

This output signal comes ON when motor 2 is selected with the **M2/M1** terminal command assigned to a digital input terminal. For details, refer to the descriptions of E01 through E05 (Function code data = 12).

■ Brake signal -- **BRKS** (Function code data = 57)

This signal outputs a brake control command that releases or activates the brake. Refer to the descriptions of J68 through J72.

■ Alarm output (for any alarm) -- **ALM** (Function code data = 99)

This output signal comes ON if any of the protective functions is activated and the inverter enters Alarm mode.

E29	Frequency Arrival Delay Time (for FAR2)
E30	Frequency Arrival (Hysteresis width for FAR and FAR2)

The moment the output frequency reaches the zone defined by "Reference frequency  $\pm$  Hysteresis width specified by E30," the "Frequency arrival signal" **FAR** comes ON. After the delay time specified by E29, the "Frequency arrival signal 2" **FAR2** comes ON. For details about the operation timings, refer to the graph below.

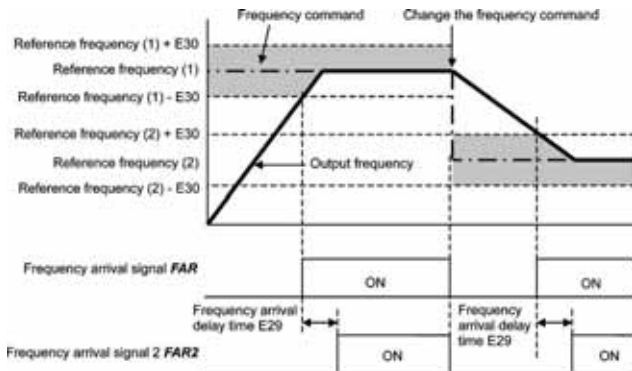

E34, E35	Overload Early Warning/Current Detection (Level and Timer)
E37, E38	Current Detection 2 (Level and Timer)

These function codes define the detection level and time for the "Motor overload early warning" **OL**, "Current detected" **ID**, and "Current detected 2" **ID2** output signals.

■ Motor overload early warning signal -- **OL**

The **OL** signal is used to detect a symptom of an overload condition (alarm code  $\overline{OL}$  /) of the motor so that the user can take an appropriate action before the alarm actually happens.

The **OL** signal turns ON when the inverter output current has exceeded the level specified by E34. In typical cases, set E34 data to 80 to 90% against F11 data (Electronic thermal overload protection for motor 1, Overload detection level). Specify also the thermal characteristics of the motor with F10 (Select motor characteristics) and F12 (Thermal time constant). To utilize this feature, you need to assign **OL** (data = 7) to any of the digital output terminals.

■ Current detected and Current detected 2 signals -- **ID** and **ID2**

When the inverter output current has exceeded the level specified by E34 or E37 and it continues longer than the period specified by E35 or E38, the **ID** or **ID2** signal turns ON, respectively. When the output current drops below 90% of the rated operation level, the **ID** or **ID2** turns OFF. (Minimum width of the output signal: 100 ms)

To utilize this feature, you need to assign **ID** (data = 37) or **ID2** (data = 38) to any of digital output terminals.

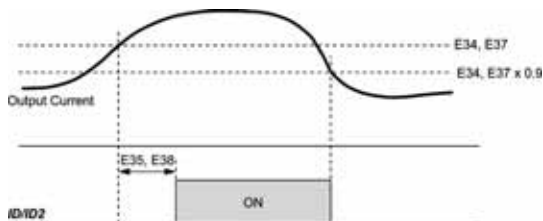

**E39** Coefficient for Constant Feeding Rate Time  
**E50** Coefficient for Speed Indication

E39 and E50 specify coefficients for determining the constant feeding rate time, load shaft speed, and line speed, as well as for displaying the output status monitored.

Calculation expression

$$\text{Constant feeding rate time (min)} = \frac{\text{Coefficient for speed indication (E50)}}{\text{Frequency} \times \text{Coefficient for constant feeding rate time (E39)}}$$

$$\text{Load shaft speed} = \text{Coefficient for speed indication (E50)} \times \text{Frequency (Hz)}$$

$$\text{Line speed} = \text{Coefficient for speed indication (E50)} \times \text{Frequency (Hz)}$$

Where, the "frequency" refers to the "reference frequency" to be applied for settings (constant feeding rate time, load shaft speed, or line speed), or to the "output frequency before slip compensation" to be applied for monitor.

If the constant feeding rate time is 999.9 min. or more or the denominator of the right-hand side is zero (0), "999.9" appears.

**E51** Display Coefficient for Input Watt-hour Data

Use this coefficient (multiplication factor) for displaying the input watt-hour data ( $\overline{5} \cdot \overline{17}$ ) in a part of maintenance information on the keypad.

$$\text{Input watt-hour data} = \text{Display coefficient (E51 data)} \times \text{Input watt-hour (kWh)}$$



Setting E51 data to 0.000 clears the input watt-hour and its data to "0." After clearing, be sure to restore E51 data to the previous value; otherwise, input watt-hour data will not be accumulated.

**E59** Terminal [C1] Signal Definition (C1/V2 function)

E59 defines the property of terminal [C1] for either a current input +4 to +20 mA DC (C1 function) or a voltage input 0 to +10 VDC (V2 function). In addition to this setting, you need to turn SW7 on the interface PCB to the corresponding position as listed below.

Data for E59	Input configuration	SW7 position
0	Current input: 4 to 20 mA DC (C1 function)	C1
1	Voltage input: 0 to +10 VDC (V2 function)	V2



E61	Terminal [12] Extended Function
E62	Terminal [C1] Extended Function (C1 function)
E63	Terminal [C1] Extended Function (V2 function)

E61, E62, and E63 define the property of terminals [12], [C1] (C1 function), and [C1] (V2 function), respectively.

There is no need to set up these terminals if they are to be used for frequency command sources.

Data for E61, E62, or E63	Function	Description
0	None	--
1	Auxiliary frequency command 1	This is an auxiliary analog frequency input to be added to frequency command 1 (F01). It is never added to frequency command 2, multi-frequency command or other frequency commands.
2	Auxiliary frequency command 2	This is an auxiliary analog frequency input to be added to all frequency commands including frequency command 1, frequency command 2 and multi-frequency commands.
3	PID command 1	This input includes temperature, pressure or other commands to apply under the PID control. Function code J02 should be also configured.
5	PID feedback amount	This input includes the feedback of the temperature or pressure under the PID control.

 **Note** If these terminals have been set up to have the same data, the operation priority is given in the following order:

E61 > E62 > E63

Selecting the **UP/DOWN** control (F01, C30 = 7) ignores auxiliary frequency command 1 and 2.

## E65 Reference Loss Detection (Continuous running frequency)

When the analog frequency command (entered through terminals [12] and [C1] (C1/V2 function)) has dropped below 10% of the expected frequency command within 400 ms, the inverter presumes that the analog frequency command wire has been broken and continues its operation at the frequency determined by the ratio specified by E65 to the reference frequency. When the frequency command level (in voltage or current) returns to a level higher than that specified by E65, the inverter presumes that the broken wire has been fixed and continues to run following the frequency command.



 **Note** Avoid an abrupt voltage or current change for the analog frequency command. The abrupt change may be interpreted as a wire break.

Setting E65 data at "999" (Disable) allows the "Reference loss detected" signal **REF OFF** to be issued, but does not allow the reference frequency to change (the inverter runs at the analog frequency command as specified).



When E65 = "0" or "999," the reference frequency level at which the broken wire is recognized as fixed is " $f_1 \times 0.2$ ."

When E65 = "100" (%) or higher, the reference frequency level at which the broken wire is recognized as fixed is " $f_1 \times 1$ ."

The reference loss detection is not affected by the setting of analog input adjustment (filter time constants: C33, C38, and C43).

C21 enables or disables a timer operation that is triggered by a run command and continues for the timer count previously specified with the   keys. The operating procedure for the timer operation is given below.

Data for C21	Function
0	Disable timer operation
1	Enable timer operation





-  Pressing the  key during timer countdown quits the timer operation.
- Even if C21 = 1, setting the timer to 0 no longer starts the timer operation with the  key.
- Applying terminal command **FWD** or **REV** instead of the key command can also start the timer operation.



#### Operating procedure for timer operation (example)

##### Preparation

- Set E43 data to "13" (LED monitor) to display the timer count on the LED monitor and set C21 to "1" (Enable timer operation).
- Specify the reference frequency to apply to timer operation. When the keypad is selected as a frequency command source, press the  key to shift to the speed monitor and specify the desired reference frequency.

##### Triggering the timer operation with the key

- (1) While watching the timer count displayed on the LED monitor, press the   key to set the timer for the desired count in seconds. Note that the timer count on the LED monitor appears as an integral number without a decimal point.
- (2) Press the  key. The motor starts running and the timer starts counting down. If the timer counts down, the motor stops without pressing the  key. (Even if the LED monitor displays any item except the timer count, the timer operation is possible.)

 After the countdown of the timer operation triggered by a terminal command such as **FWD**, the inverter decelerates to stop and at that moment the LED monitor displays *Err* and any LED monitor item ( for the timer count) alternately. Turning **FWD** OFF returns to the LED monitor item.

---

C31, C33	Analog Input Adjustment for [12] (Offset and Filter time constant)
C36, C38	Analog Input Adjustment for [C1] (C1 function) (Offset and Filter time constant)
C41, C43	Analog Input Adjustment for [C1] (V2 function) (Offset and Filter time constant)

---

C31, C36 or C41 configures an offset for an analog voltage/current input at terminal [12], [C1] (C1 function) or [C1] (V2 function), respectively. The offset also applies to signals sent from the external equipment.

C33, C38 or C43 configures a filter time constant for an analog voltage/current input at terminal [12], [C1] (C1 function) or [C1] (V2 function), respectively. The larger the time constant, the slower the response. Specify the proper filter time constant taking into account the response speed of the machine (load). If the input voltage fluctuates due to line noises, increase the time constant.

---

**P01** Motor 1 (No. of poles)

P01 specifies the number of poles of the motor. Enter the value given on the nameplate of the motor. This setting is used to display the motor speed on the LED monitor (refer to E43). The following expression is used for the conversion.

$$\text{Motor speed (r/min)} = \frac{120}{\text{No. of poles}} \times \text{Frequency (Hz)}$$

---

**P02** Motor 1 (Rated capacity)

P02 specifies the rated capacity of the motor. Enter the rated value given on the nameplate of the motor.

Data for P02	Unit	Remarks
0.01 to 30.00	kW	When P99 = 0, 3 or 4
	HP	When P99 = 1

---

**P03** Motor 1 (Rated current)

P03 specifies the rated current of the motor. Enter the rated value given on the nameplate of the motor.

---

**P04** Motor 1 (Auto-tuning)

The inverter automatically detects the motor parameters and saves them in its internal memory. Basically, it is not necessary to perform tuning when using a Fuji standard motor with a standard connection with the inverter.

In any of the following cases, perform auto-tuning since the motor parameters are different from those of Fuji standard motors so as not to obtain the best performance under each of these controls--auto torque boost, torque calculation monitoring, auto energy saving operation, torque limiter, automatic deceleration (anti-regenerative control), auto search for idling motor speed, slip compensation, torque vector, droop control, or overload stop.

- The motor to be driven is made by other manufacturer or is a non-standard motor.
- Cabling between the motor and the inverter is long.
- A reactor is inserted between the motor and the inverter.

 For details of auto-tuning, refer to Section 4.1.3 "Preparation before running the motor for a test -- Setting function code data."

---

**P05** Motor 1 (Online tuning)

The primary and secondary % resistances (%R1) and (%R2) will change as the motor temperature rises. P05 allows you to tune this change when the inverter is in operation (online)

---

**P06, P07, P08, P12** Motor 1 (No-load current, %R1, %X and Motor 1, Rated slip frequency)

P06 through P08 and P12 specify no-load current, %R1, %X, and rated slip frequency, respectively. Obtain the appropriate values from the test report of the motor or by calling the manufacturer of the motor.

Performing auto-tuning automatically sets these parameters.

- No-load current (P06): Enter the value obtained from the motor manufacturer.
- %R1 (P07): Enter the value calculated by the following expression.

$$\%R1 = \frac{R1 + \text{Cable } R1}{V / (\sqrt{3} \times I)} \times 100 (\%)$$

where,

R1: Primary resistance of the motor ( $\Omega$ )

Cable R1: Resistance of the output cable ( $\Omega$ )

V: Rated voltage of the motor (V)

I: Rated current of the motor (A)

- %X (P08): Enter the value calculated by the following expression.

$$\%X = \frac{X1 + X2 \times XM / (X2 + XM) + \text{Cable X}}{V / (\sqrt{3} \times I)} \times 100 (\%)$$

where,

X1: Primary leakage reactance of the motor ( $\Omega$ )

X2: Secondary leakage reactance of the motor (converted to primary) ( $\Omega$ )

XM: Exciting reactance of the motor ( $\Omega$ )

Cable X: Reactance of the output cable ( $\Omega$ )

V: Rated voltage of the motor (V)

I: Rated current of the motor (A)

- Rated slip frequency (P12)

Convert the value obtained from the motor manufacturer to Hz using the following expression and enter the converted value. (Note: The motor rating given on the nameplate sometimes shows a large value.)

$$\text{Rated slip frequency (Hz)} = \frac{(\text{Synchronous speed} - \text{Rated speed})}{\text{Synchronous speed}} \times \text{Base frequency}$$



For reactance, choose the value at the base frequency 1 (F04).

---

P09	Motor 1 (Slip compensation gain for driving)
P10	(Slip compensation response time)
P11	(Slip compensation gain for braking)

---

P09 and P11 determine the slip compensation amount in % for driving and braking individually. Specification of 100% fully compensates for the rated slip of the motor. Excessive compensation (P09, P11 > 100%) may cause a system oscillation, so carefully check the operation on the actual machine.

P10 determines the response time for slip compensation. Basically, there is no need to modify the default setting. If you need to modify it, consult your Fuji Electric representatives.

---

## P99 Motor 1 Selection

---

P99 specifies the motor to be used.

Data for P99	Motor type
0	Motor characteristics 0 (Fuji standard motors, 8-series)
1	Motor characteristics 1 (HP rating motors)
3	Motor characteristics 3 (Fuji standard motors, 6-series)
4	Other motors

Automatic control (such as auto torque boost and auto energy saving) or electronic thermal overload protection for motor uses the motor parameters and characteristics. To match the property of a control system with that of the motor, select characteristics of the motor and set H03 data (Data Initialization) to "2" to initialize the old motor parameters stored in the inverter. When initialization is complete, P03, P06, P07, and P08 data and the old related internal data are automatically updated.





For P99, enter the following data according to the motor type.

- P99 = 0 (Motor characteristics 0): Fuji standard 8-series motors (Current standard)
- P99 = 3 (Motor characteristics 3): Fuji standard 6-series motors (Conventional standard)
- P99 = 4 (Other motors): Other manufacturer's or unknown motors

- Note**
- If P99 = 4 (Other motors), the inverter runs following the motor characteristics of Fuji standard 8-series.
  - The inverter also supports motors rated by HP (horse power: typical in North America, P99 = 1).

## H03 Data Initialization

H03 initializes the current function code data to the factory defaults or initializes the motor parameters.

To change the H03 data, it is necessary to press the  +  keys or  +  keys (simultaneous keying).

Data for H03	Function
0	Disable initialization (Settings manually made by the user will be retained.)
1	Initialize all function code data to the factory defaults
2	Initialize motor 1 parameters in accordance with P02 (Rated capacity) and P99 (Motor 1 selection) Function codes subject to initialization: P01, P03, P06 to P12 and constants for internal control (These function codes will be initialized to the values listed in tables on the following pages.)
3	Initialize motor 2 parameters in accordance with A16 (Rated capacity) and A39 (Motor 2 selection) Function codes subject to initialization: A15, A17, A20 to A26 and constants for internal control (These function codes will be initialized to the values listed in tables on the following pages.)

- To initialize the motor parameters, set the related function codes as follows.
  - 1) P02/A16 Motor (Rated capacity) Set the rated capacity of the motor to be used in HP or kW.
  - 2) P99/A39 Motor Selection Select the characteristics of the motor.
  - 3) H03 Data Initialization Initialize the motor parameters. (H03 = 2 or 3)
  - 4) P03/A17 Motor (Rated current) Set the rated current on the nameplate if the already set data differs from the rated current printed on the nameplate of the motor.
- Upon completion of the initialization, the H03 data reverts to "0" (factory default).
- If the P02 or A16 data is set to a value other than the nominal applied motor rating, data initialization with H03 internally converts the specified value forcibly to the equivalent nominal applied motor rating (see the tables on the next page).

- When Fuji standard 8-series motors (P99 = 0) or other motors (P99 = 4 or A39 = 4) are selected, the motor parameters are as listed in the following tables.

#### 230 V class series

Motor capacity (HP)	Normal applied motor (HP)	Rated current (A)	No-load current (A)	%R (%)	%X (%)	Rated slip frequency (Hz)
		P03/A17	P06/A20	P07/A21	P08/A22	P12/A26
0.01 to 0.11	0.10	0.44	0.40	13.79	11.75	2.50
0.12 to 0.24	0.12	0.68	0.55	12.96	12.67	2.50
0.25 to 0.49	0.25	1.40	1.12	11.02	13.84	2.50
0.50 to 0.99	0.50	2.00	1.22	6.15	8.80	2.50
1.00 to 1.99	1.00	3.00	1.54	3.96	8.86	2.50
2.00 to 2.99	2.00	5.80	2.80	4.29	7.74	2.50
3.00 to 4.99	3.00	7.90	3.57	3.15	20.81	1.17
5.00 to 7.49	5.00	12.60	4.78	3.34	23.57	1.50
7.50 to 9.99	7.50	18.60	6.23	2.65	28.91	1.17
10.00 to 14.99	10.00	25.30	8.75	2.43	30.78	1.17
15.00 to 19.99	15.00	37.30	12.70	2.07	29.13	1.00
20.00 to 24.99	20.00	49.10	9.20	2.09	29.53	1.00
25.00 to 29.99	25.00	60.00	16.70	1.75	31.49	1.00
30.00	30.00	72.40	19.80	1.90	32.55	1.00

#### 460 V class series

Motor capacity (HP)	Normal applied motor (HP)	Rated current (A)	No-load current (A)	%R (%)	%X (%)	Rated slip frequency (Hz)
		P03/A17	P06/A20	P07/A21	P08/A22	P12/A26
0.01 to 0.11	0.10	0.22	0.20	13.79	11.75	2.50
0.12 to 0.24	0.12	0.34	0.27	12.96	12.67	2.50
0.25 to 0.49	0.25	0.70	0.56	11.02	13.84	2.50
0.50 to 0.99	0.50	1.00	0.61	6.15	8.80	2.50
1.00 to 1.99	1.00	1.50	0.77	3.96	8.86	2.50
2.00 to 2.99	2.00	2.90	1.40	4.29	7.74	2.50
3.00 to 4.99	3.00	4.00	1.79	3.15	20.81	1.17
5.00 to 7.49	5.00	6.30	2.39	3.34	23.57	1.50
7.50 to 9.99	7.50	9.30	3.12	2.65	28.91	1.17
10.00 to 14.99	10.00	12.70	4.37	2.43	30.78	1.17
15.00 to 19.99	15.00	18.70	6.36	2.07	29.13	1.00
20.00 to 24.99	20.00	24.60	4.60	2.09	29.53	1.00
25.00 to 29.99	25.00	30.00	8.33	1.75	31.49	1.00
30.00	30.00	36.20	9.88	1.90	32.55	1.00

## H04, H05 Auto-reset (Times and Reset interval)

H04 and H05 specify the auto-reset function that makes the inverter automatically attempt to reset the tripped state and restart without issuing an alarm (for any faults) even if any protective function subject to reset is activated and the inverter enters the forced-to-stop state (tripped state). If the protective function works in excess of the times specified by H04, the inverter will issue an alarm (for any faults) and not attempt to auto-reset the tripped state.

Listed below are the recoverable alarm statuses to be retried.

Alarm status	LED monitor displays:	Alarm status	LED monitor displays:
Overcurrent protection	<i>OC 1, OC2 or OC3</i>	Motor overheated	<i>OH1</i>
Overvoltage protection	<i>OV 1, OV2 or OV3</i>	Motor overloaded	<i>OL 1 or OL2</i>
Heat sink overheated	<i>OH1</i>	Inverter overloaded	<i>OLU</i>
Braking resistor overheated	<i>dbH</i>		

### ■ Number of reset times (H04)

H04 specifies the number of reset times for automatically escaping the tripped state. When H04 = 0, the auto-reset function will not be activated.

## ⚠ WARNING

If the "auto-reset" function has been specified, the inverter may automatically restart and run the motor stopped due to a trip fault, depending on the cause of the tripping.

Design the machinery so that human body and peripheral equipment safety is ensured even when the auto-resetting succeeds.

**Otherwise an accident could occur.**

### ■ Reset interval (H05)

After the reset interval specified by H05 from when the inverter enters the tripped state, it issues a reset command to auto-reset the tripped state. Refer to the timing scheme diagrams below.

<Timing scheme for failed retry (No. of reset times: 3)>

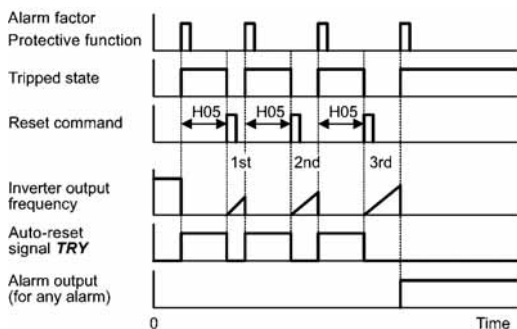

- The reset operation state can be monitored by external equipment via the inverter's digital output terminal [Y1], [Y2], or [30A/B/C] to which the **TRY** is assigned by setting "26" with function code E20, E21, or E27.

## H06 Cooling Fan ON/OFF Control

To prolong the life of the cooling fan and reduce fan noise during running, the cooling fan stops when the temperature inside the inverter drops below a certain level while the inverter stops. However, since frequent switching of the cooling fan shortens its life, the cooling fan is kept running for 10 minutes once it is started.

H06 specifies whether to keep running the cooling fan all the time or to control its ON/OFF.

Data for H06	Cooling fan ON/OFF
0	Disable (Always in operation)
1	Enable (ON/OFF controllable)

## H07 Acceleration/Deceleration Pattern

H07 specifies the acceleration and deceleration patterns (patterns to control output frequency).

### Linear acceleration/deceleration

The inverter runs the motor with the constant acceleration and deceleration.

### S-curve acceleration/deceleration

To reduce an impact that acceleration/deceleration would make on the machine, the inverter gradually accelerates/decelerates the motor in both the acceleration/deceleration starting and ending zones. Two types of S-curve acceleration/deceleration are available; 5% (weak) and 10% (strong) of the maximum frequency, which are shared by the four inflection points. The acceleration/deceleration time command determines the duration of acceleration/deceleration in the linear period; hence, the actual acceleration/deceleration time is longer than the reference acceleration/deceleration time.

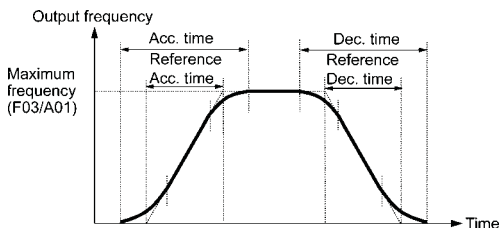



Acceleration/deceleration time

<S-curve acceleration/deceleration (weak): when the frequency change is 10% or more of the maximum frequency>

Acceleration or deceleration time (s):  $(2 \times 5/100 + 90/100 + 2 \times 5/100) \times (\text{reference acceleration or deceleration time})$   
=  $1.1 \times (\text{reference acceleration or deceleration time})$

<S-curve acceleration/deceleration (strong): when the frequency change is 20% or more of the maximum frequency>

Acceleration or deceleration time (s):  $(2 \times 10/100 + 80/100 + 2 \times 10/100) \times (\text{reference acceleration or deceleration time})$   
=  $1.2 \times (\text{reference acceleration or deceleration time})$

#### Curvilinear acceleration/deceleration

Acceleration/deceleration is linear below the base frequency (constant torque) but it slows down above the base frequency to maintain a certain level of load factor (constant output).

This acceleration/deceleration pattern allows the motor to accelerate or decelerate with the maximum performance of the motor.



Choose an appropriate acceleration/deceleration time, taking into account the machinery's load torque.

---

## H09, H49 Starting Mode (Auto search and Delay time)

---

H09 specifies the auto search mode for idling motor speed to run the idling motor without stopping it.

The auto search applies to both a restart of the inverter after a momentary power failure and every normal startup.

The auto search mode can be switched by assigning an **STM** terminal command ("Enable auto search for idling motor speed at starting") to a digital input terminal with any of E01 to E05 (function code data = 26). If no **STM** is assigned, the inverter interprets **STM** as being OFF by default.

#### Auto search for idling motor speed

Starting the inverter (with a run command ON, **BX** OFF, auto-reset, etc.) with **STM** being ON searches for the idling motor speed for a maximum of 1.2 seconds to run the idling motor without stopping it. After completion of the auto search, the inverter accelerates the motor up to the reference frequency according to the frequency command and the preset acceleration time.

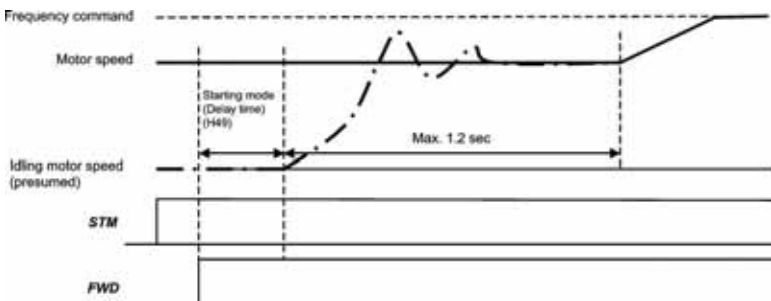

Auto search for idling motor speed to follow

■ H09 and **STM** terminal command ("Enable auto search for idling motor speed at starting")

The combination of H09 data and the **STM** state determines whether to perform the auto search as listed below.

Data for H09	<b>STM</b>	Auto search for idling motor speed at starting	
		For restart after momentary power failure (F14 = 4 or 5)	For normal startup
0: Disable	OFF	Disable	Disable
1: Enable	OFF	Enable	Disable
2: Enable	OFF	Enable	Enable
--	ON	Enable	Enable



When the inverter is equipped with any of output circuit filters OFL-□□□-2 and -4 in the secondary lines, it cannot perform auto search. Use the filter OFL-□□□-□□ instead.

■ Auto search delay time (H49)

Auto search for the idling motor speed will become unsuccessful if it is done while the motor retains residual voltage. It is, therefore, necessary to leave the motor for an enough time for residual voltage to disappear. H49 specifies that time (0.0 to 10.0 sec.).

At the startup triggered by a run command ON, auto search starts with the delay specified by H49. When two inverters share a single motor to drive it alternately, coast to stop it, and perform auto search every switching, H49 can eliminate the need of the run command timing control.

The H49 data should be the same value as the H13 data (Restart Mode after Momentary Power Failure, Restart time). At the restart after a momentary power failure, at the start by turning the terminal command **BX** ("Coast to a stop") OFF and ON, or at the restart by auto-reset, the inverter applies the delay time specified by H13. The inverter will not start unless the time specified by H13 has elapsed, even if the starting conditions are satisfied.



- Be sure to auto-tune the inverter preceding the start of auto search for the idling motor speed.
- When the estimated speed exceeds the maximum frequency or the upper limit frequency, the inverter disables auto search and starts in normal mode.
- In auto search with the restart after momentary power failure enabled (F14 = 4 or 5) and the allowable momentary power failure time specified (H16), turning a run command ON will start auto search even if the time specified by H16 has elapsed.
- During auto search, if an overcurrent or overvoltage trip occurs, the inverter restarts the suspended auto search.
- Perform auto search at 60 Hz or below.
- Note that auto search may not fully provide the expected/designed performance depending on conditions including the load, motor parameters, power cable length, and other externally determined events.

## H11 Deceleration Mode

H11 specifies the deceleration mode to be applied when a run command is turned OFF.

Data for H11	Function
0	Normal deceleration The inverter decelerates and stops the motor according to deceleration commands specified by H07 (Acceleration/deceleration pattern), F08 (Deceleration time 1), and E11 (Deceleration time 2).
1	Coast-to-stop The inverter immediately shuts down its output, so the motor stops according to the inertia of the motor and machine and their kinetic energy losses.



When reducing the reference frequency, the inverter decelerates the motor according to the deceleration commands even if H11 = 1 (Coast-to-stop).

## H12 Instantaneous Overcurrent Limiting (Mode selection)

H12 specifies whether the inverter invokes the current limit processing or enters the overcurrent trip when its output current exceeds the instantaneous overcurrent limiting level. Under the current limit processing, the inverter immediately turns OFF its output gate to suppress the further current increase and continues to control the output frequency.

Data for H12	Function
0	Disable An overcurrent trip occurs at the instantaneous overcurrent limiting level.
1	Enable The current limiting operation is effective.

If any problem occurs when the motor torque temporarily drops during current limiting processing, it is necessary to cause an overcurrent trip (H12 = 0) and actuate a mechanical brake at the same time.



The similar function is the current limiter specified by F43 and F44. The current limiter (F43/F44) implements the current control by software, so an operation delay occurs. When you have enabled the current limiter (F43/F44), also enable the instantaneous overcurrent limiting with H12 to obtain a quick response current limiting.

Depending on the load, extremely short acceleration time may activate the current limiting to suppress the increase of the inverter output frequency, causing the system oscillation (hunting) or activating the inverter overvoltage trip (alarm  $\overline{UV}$ ). When specifying the acceleration time, therefore, you need to take into account machinery characteristics and moment of inertia of the load.

### CAUTION

When the instantaneous overcurrent limiting is enabled, the motor output torque could drop. For driving elevating machinery which could cause a serious problem with a drop of the motor output torque, therefore, disable the instantaneous overcurrent limiting. Note that disabling it will cause an overcurrent trip when a current exceeding the inverter protection level flows, so secure the protective coordination using a mechanical brake.

**An accident could occur.**

In a system in which two or more motors drive single machinery, any speed gap between inverter-driven motors results in some load unbalance between motors. The droop control allows each inverter to drive the motor with the speed droop characteristics for increasing its load, eliminating such kind of load unbalance.

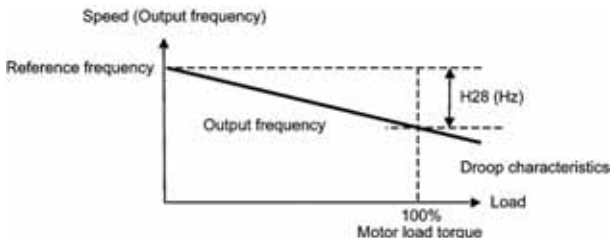

To use droop control, be sure to auto-tune the inverter for the motor.

Using the RS-485 communications link (standard/option) or field bus (option) allows you to issue frequency commands and run commands from a computer or PLC at a remote location, as well as monitoring the inverter running information and the function code data.

H30 and y98 specify the sources of those commands—"inverter itself" and "computers or PLCs via the RS-485 communications link or field bus." H30 is for the RS-485 communications link; y98 for the field bus.

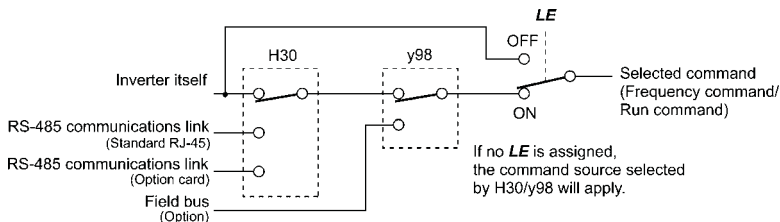

#### Command sources selectable

Command sources	Description
Inverter itself	Sources except RS-485 communications link and field bus Frequency command source: Specified by F01/C30, or multi-frequency command Run command source: Via the keypad or digital input terminals selected by F02
Via RS-485 communications link (standard)	Via the standard RJ-45 port used for connecting keypad
Via RS-485 communications link (option card)	Via RS-485 communications link (option card)
Via field bus (option)	Via field bus (option) using FA protocol such as DeviceNet or PROFIBUS-DP

### Command sources specified by H30 (Mode selection)

Data for H30	Frequency command	Run command
0	Inverter itself (F01/C30)	Inverter itself (F02)
1	Via RS-485 communications link (standard)	Inverter itself (F02)
2	Inverter itself (F01/C30)	Via RS-485 communications link (standard)
3	Via RS-485 communications link (standard)	Via RS-485 communications link (standard)
4	Via RS-485 communications link (option card)	Inverter itself (F02)
5	Via RS-485 communications link (option card)	Via RS-485 communications link (standard)
6	Inverter itself (F01/C30)	Via RS-485 communications link (option card)
7	Via RS-485 communications link (standard)	Via RS-485 communications link (option card)
8	Via RS-485 communications link (option card)	Via RS-485 communications link (option card)

### Command sources specified by y98

Data for y98	Frequency command	Run command
0	Follow H30 data	Follow H30 data
1	Via field bus (option)	Follow H30 data
2	Follow H30 data	Via field bus (option)
3	Via field bus (option)	Via field bus (option)

### Combination of command sources

		Frequency command			
		Inverter itself	Via RS-485 communications link (standard)	Via RS-485 communications link (option card)	Via field bus (option)
Run command source	Inverter itself	H30 = 0 y98 = 0	H30 = 1 y98 = 0	H30=4 y98=0	H30=0 (1 or 4) y98=1
	Via RS-485 communications link (standard)	H30 = 2 y98 = 0	H30 = 3 y98 = 0	H30=5 y98=0	H30=2 (3 or 5) y98=1
	Via RS-485 communications link (option card)	H30 = 6 y98 = 0	H30 = 7 y98 = 0	H30=8 y98=0	H30=6 (7 or 8) y98=1
	Via field bus (option)	H30 = 0 (2 or 6) y98 = 2	H30 = 1 (3 or 7) y98 = 2	H30 = 4 (5 or 8) y98 = 2	H30 = 0 (1 to 8) y98 = 3



For details, refer to the FRENIC-Multi User's Manual, Chapter 4 "BLOCK DIAGRAMS FOR CONTROL LOGIC" and the RS-485 Communication User's Manual or the Field Bus Option Instruction Manual.

H45	Mock Alarm
H97	Clear Alarm Data

H45 causes the inverter to generate a mock alarm in order to check whether external sequences function correctly at the time of machine setup.

Setting the H45 data to "1" displays mock alarm  $\mathcal{E}_{rr}$  on the LED monitor and issues alarm output **ALM** to the digital output terminal specified (see E20, E21 and E27). (Accessing the H45 data requires simultaneous keying of "←" key + "↵" key.) After that, the H45 data automatically reverts to "0," allowing you to reset the alarm.

Just as for data (alarm history and relevant information) of those alarms that could occur in running of the inverter, the inverter saves mock alarm data, enabling you to confirm the mock alarm status.

To clear the mock alarm data, use H97. (Accessing the H97 data requires simultaneous keying of "←" key + "↵" key.) For details, refer to the description of H97.

H69	Automatic Deceleration (Anti-regenerative control) (Mode selection)
H76	Torque Limiter (Frequency increment limit for braking)

H69 enables or disables the anti-regenerative control.

In the inverter not equipped with a PWM converter or braking unit, if the regenerative energy returned exceeds the inverter's braking capability, an overvoltage trip occurs.

To avoid such an overvoltage trip, enable the automatic deceleration (anti-regenerative control) with this function code, and the inverter controls the output frequency to keep the braking torque around 0 Nm in both the acceleration/deceleration and constant speed running phases.

Since increasing the output frequency too much in the anti-regenerative control is dangerous, the inverter has a torque limiter (Frequency increment limit for braking) that can be specified by H76. The torque limiter limits the inverter's output frequency to less than "Reference frequency + H76 setting."

Note that the torque limiter activated restrains the anti-regenerative control, resulting in a trip with an overvoltage alarm in some cases. Increasing the H76 data (0.0 to 400.0 Hz) makes the anti-regenerative control capability high.

In addition, during deceleration triggered by turning the run command OFF, the anti-regenerative control increases the output frequency so that the inverter may not stop the load depending on the load state (huge moment of inertia, for example). To avoid that, H69 provides a choice of cancellation of the anti-regenerative control to apply when three times the specified deceleration time is elapsed, thus decelerating the motor.

Data for H69	Function
0	Disable
2	Enable (Canceled if actual deceleration time exceeds three times the one specified by F08/E11.)
4	Enable (Not canceled even if actual deceleration time exceeds three times the one specified by F08/E11.)



Enabling the anti-regenerative control may automatically increase the deceleration time.

When a braking unit is connected, disable the anti-regenerative control.

---

## H70 Overload Prevention Control

---

H70 specifies the decelerating rate of the output frequency to prevent a trip from occurring due to an overload. This control decreases the output frequency of the inverter before the inverter trips due to a heat sink overheat or inverter overload (with an alarm indication of  $\overline{OH}$  or  $\overline{OL}$ , respectively). It is useful for equipment such as pumps where a decrease in the output frequency leads to a decrease in the load and it is necessary to keep the motor running even when the output frequency drops.

Data for H70	Function
0.00	Decelerate the motor by selected deceleration time
0.01 to 100.0	Decelerate the motor by deceleration rate from 0.01 to 100.0 (Hz/s)
999	Disable overload prevention control

 In equipment where a decrease in the output frequency does not lead to a decrease in the load, the overload prevention control is of no use and should not be enabled.

---

## H71 Deceleration Characteristics

---

Setting the H71 data to "1" (ON) enables forced brake control. If regenerative energy produced during the deceleration of the motor and returned to the inverter exceeds the inverter's braking capability, an overvoltage trip will occur. The forced brake control increases the motor energy loss during deceleration, increasing the deceleration torque.

 This function is aimed at controlling the torque during deceleration; it has no effect if there is braking load.

Enabling the automatic deceleration (anti-regenerative control, H69 = 2 or 4) disables the deceleration characteristics specified by H71.

---

## H89 Motor overload memory retention

---

This is Motor overload memory (Electrical thermal O/L relay) retention selection at power up.

H89 set to:	To do this
0	Inactive When power up the drive, Motor overload data is reset.
1	Active When power is down, the drive stores Motor overload data and use this data at next power up.

---

## H94 Cumulative Motor Run Time 1

---

Operating the keypad can display the cumulative run time of motor 1. This feature is useful for management and maintenance of the mechanical system. H94 allows you to set the cumulative run time of the motor to the desired value. For example, specifying "0" clears the cumulative run time of the motor.

 The H94 data is in hexadecimal notation. It appears in decimal notation on the keypad.

---

## H98 Protection/Maintenance Function (Mode selection)

---

H98 specifies whether to enable or disable (a) automatic lowering of carrier frequency, (b)

input phase loss protection, (c) output phase loss protection, and (d) judgment on the life of the DC link bus capacitor, as well as specifying the judgment threshold on the life of the DC link bus capacitor, in a style of combination (Bit 0 to Bit 4).

#### Automatic lowering of carrier frequency (Bit 0)

This function should be used for important machinery that requires keeping the inverter running.

Even if a heat sink overheat or overload occurs due to excessive load, abnormal ambient temperature, or cooling system failure, enabling this function lowers the carrier frequency to avoid tripping ( $\overline{OHI}$  or  $\overline{OLU}$ ). Note that enabling this function results in increased motor noise.



### Input phase loss protection (L<sub>17</sub>) (Bit 1)

Upon detection of an excessive stress inflicted on the apparatus connected to the main circuit due to phase loss or line-to-line voltage unbalance in the three-phase power supplied to the inverter, this feature stops the inverter and displays an alarm L<sub>17</sub>.

 In configurations where only a light load is driven or a DC reactor is connected, phase loss or line-to-line voltage unbalance may not be detected because of the relatively small stress on the apparatus connected to the main circuit.

### Output phase loss protection (L<sub>PL</sub>) (Bit 2)

Upon detection of phase loss in the output while the inverter is running, this feature stops the inverter and displays an alarm L<sub>PL</sub>. Where a magnetic contactor is installed in the inverter output circuit, if the magnetic contactor goes OFF during operation, all the phases will be lost. In such a case, this protection feature does not work.

### Judgment threshold on the life of DC link bus capacitor (Bit 3)

Bit 3 is used to select the threshold for judging the life of the DC link bus capacitor between factory default setting and your own choice.

 Before specifying the threshold of your own choice, measure and confirm the reference level in advance.

### Judgment on the life of DC link bus capacitor (Bit 4)

Whether the DC link bus capacitor has reached its life is determined by measuring the length of time for discharging after power OFF. The discharging time is determined by the capacitance of the DC link bus capacitor and the load inside the inverter. Therefore, if the load inside the inverter fluctuates significantly, the discharging time cannot be accurately measured, and as a result, it may be mistakenly determined that the life has been reached. To avoid such an error, you can disable the judgment on the life of the DC link bus capacitor.

Since load may vary significantly in the following cases, disable the judgment on the life during operation. Either conduct the measurement with the judgment enabled under appropriate conditions during periodical maintenance or conduct the measurement under the operating conditions matching the actual ones.

- An option card or multi-function keypad is used.
- Another inverter or equipment such as a PWM converter is connected to the terminals of the DC link bus.

To set data of H98, assign functions to each bit (total 5 bits) and set it in decimal format. The table below lists functions assigned to each bit.

Bit number	Bit 4	Bit 3	Bit 2	Bit 1	Bit 0
Function	Judge the life of DC link bus capacitor	Select life judgment threshold of DC link bus capacitor	Detect output phase loss	Detect input phase loss	Lower the carrier frequency automatically
Data = 0	Disable	Use the factory default	Disable	Disable	Disable
Data = 1	Enable	Use the user setting	Enable	Enable	Enable
Example of decimal expression (19)	Enable (1)	Use the factory default (0)	Disable (0)	Enable (1)	Enable (1)

Conversion table (Decimal to/from binary)

Decimal	Binary					Decimal	Binary				
	Bit 4	Bit 3	Bit 2	Bit 1	Bit 0		Bit 4	Bit 3	Bit 2	Bit 1	Bit 0
0	0	0	0	0	0	16	1	0	0	0	0
1	0	0	0	0	1	17	1	0	0	0	1
2	0	0	0	1	0	18	1	0	0	1	0
3	0	0	0	1	1	19	1	0	0	1	1
4	0	0	1	0	0	20	1	0	1	0	0
5	0	0	1	0	1	21	1	0	1	0	1
6	0	0	1	1	0	22	1	0	1	1	0
7	0	0	1	1	1	23	1	0	1	1	1
8	0	1	0	0	0	24	1	1	0	0	0
9	0	1	0	0	1	25	1	1	0	0	1
10	0	1	0	1	0	26	1	1	0	1	0
11	0	1	0	1	1	27	1	1	0	1	1
12	0	1	1	0	0	28	1	1	1	0	0
13	0	1	1	0	1	29	1	1	1	0	1
14	0	1	1	1	0	30	1	1	1	1	0
15	0	1	1	1	1	31	1	1	1	1	1

### J63 to J67 Overload Stop (Detection value, Detection level, Mode selection, Operation condition and Timer)

When the monitored status index of the load exceeds the detection level specified by J64 for the period specified by J67, the inverter activates the overload stop function according to operation specified by J65. Use this function for such as system protection from applying a load that cannot be allowed by the system characteristics or any reason on the system design or system in which the motor spindle is locked by a mechanical stopper.

#### ■ Detection value (J63)

J63 specifies the detection value of status index to be monitored.

Data for J63	Detection value	Description
0	Output torque	To improve the accuracy of torque calculation, be sure to auto-tune the inverter for the applied motor. This setting covers the driving torque only.
1	Output current	The no-load current to the motor always flows. Specify J64 (Detection level) correctly considering the no-load current of the applied motor.

#### ■ Detection level (J64)

J64 specifies the detection level assuming the inverter rated current and motor rated torque as 100%.

 **Note** When J65 = 3 (Hit and stop), the detection level (J64) is determined based on not the J63 data but the motor rated torque.

### ■ Mode selection (J65)

J65 specifies operation when the load amount exceeds that of one specified by J64.

Data for J65	Mode	Description
0	Disable	The inverter cancels the overload stop function.
1	Decelerate to stop	The inverter decelerate-to-stops the motor by the specified deceleration time.
2	Coast to a stop	The inverter shuts down the output immediately, and the motor coast-to-stops.
3	Hit and stop	The inverter decelerates the motor with the torque limit operation, and is controlling the output current to keep the hold torque until the run command turned OFF. Make the mechanical brake turn ON before turning the run command OFF. The inverter issues an alarm <b>IOL</b> or <b>IOL2</b> during the hit and stop operation.



- Once the overload stop function is activated, the inverter holds it and cannot accelerate the motor again. To reaccelerate the motor, turn the run command OFF and ON again.
- If J65 = 3, the inverter ignores the driving torque limit operation already specified.

### ■ Operation condition (J66)

J66 specifies the inverter's operation state to apply the overload stop function.

Note that carefully specify it so as not to induce a malfunction by any setting that is not needed.

Data for J66	Applicable operation mode
0	Takes effect in the constant speed or deceleration operation mode.
1	Takes effect in the constant speed operation mode.
2	Takes effect in all the operation modes.

### ■ Timer (J67)

J67 configures the timer to suppress any activation of the overload stop function by any unexpected momentary load fluctuation.

If an activation condition of the overload stop function is taken for the time specified by the timer J67, the inverter activate it in case of J65 = 1 or 2.



- If J65 = 3, the timer setting is ignored. In this case, the inverter decelerates the motor instantaneously with the torque limit function so that referring to the timer is to interfere running of this function.

---

## J68 to J72 Braking Signal (Brake OFF current, Brake OFF frequency, Brake OFF timer, Brake ON frequency and Brake ON timer)

These function codes are for the brake releasing/turning-on signals of hoisting/elevating machines.

### Releasing the Brake

The inverter releases the brake (Terminal command **BRKS**: ON) after checking torque generation of the motor, monitoring whether it applies both the output current and frequency to the motor, which are higher than ones specified for the time long enough.

Function code	Name	Data setting range
J68	Brake OFF current	0 to 200%: Set it putting the inverter rated current at 100%.
J69	Brake OFF frequency	0.0 to 25.0 Hz
J70	Brake OFF timer	0.0 to 5.0 s

### Turning-on the brake

To assure the service life of brake body, the inverter checks the motor speed lowering enough less than one specified, monitoring that the run command turns OFF and the output frequency lowers than one specified for the time long enough, and turn-on the brake (terminal command **BRKS**: OFF.)

Function code	Name	Data setting range
J71	Brake ON frequency	0.0 to 25.0 Hz
J72	Brake ON timer	0.0 to 5.0 s



- The braking signal control is only applicable to motor 1. If the motor switching function selects motor 2, the braking signal always remains at state of turning-on.
- When an event such as an occurrence of alarm and turning the coast-to-stop terminal command **BX** ON shuts down the inverter, the braking signal turns-on immediately.

## Chapter 6 TROUBLESHOOTING

### 6.1 Before Proceeding with Troubleshooting

# ⚠ WARNING

If any of the protective functions have been activated, first remove the cause. Then, after checking that the all run commands are set to off, reset the alarm. Note that if the alarm is reset while any run commands are set to on, the inverter may supply the power to the motor which may cause the motor to rotate.

#### Injury may occur.

- Even though the inverter has interrupted power to the motor, if the voltage is applied to the main circuit power input terminals L1/R, L2/S and L3/T (L1/L and L2/N for single-phase voltage input), voltage may be output to inverter output terminals U, V, and W.
- Turn OFF the power and wait more than five minutes. Make sure that the LED monitor is turned OFF. Further, make sure, using a multimeter or a similar instrument, that the DC link bus voltage between the terminals P (+) and N (-) has dropped below the safe voltage (+25 VDC).

#### Electric shock may occur.

Follow the procedure below to solve problems.

- (1) First, check that the inverter is correctly wired, referring to Chapter 2 Section 2.3.5 "Wiring for main circuit terminals and grounding terminals."
- (2) Check whether an alarm code is displayed on the LED monitor.

#### ● No alarm code appears on the LED monitor

##### Abnormal motor operation

- [1] The motor does not rotate.
- [2] The motor rotates, but the speed does not increase.
- [3] The motor runs in the opposite direction to the command.
- [4] If the speed variation and current vibration (such as hunting) occur at the constant speed
- [5] If grating sound can be heard
- [6] The motor does not accelerate and decelerate at the set time.
- [7] Even if the power recovers after an instantaneous power failure, the motor does not restart.
- [8] The inverter does not run as expected.

→ Go to Section 6.2.1

##### Problems with inverter settings

- [1] Nothing appears on the LED monitor.
- [2] The desired menu is not displayed.
- [3] Data of function codes cannot be changed

→ Go to Section 6.2.2

#### ● If an alarm code appears on the LED monitor

→ Go to Section 6.3

#### ● If an abnormal pattern appears on the LED monitor while no alarm code is displayed

→ Go to Section 6.4

If any problems persist after the above recovery procedure, contact your Fuji Electric representative.

## 6.2 If No Alarm Code Appears on the LED Monitor

### 6.2.1 Motor is running abnormally

#### [ 1 ] The motor does not rotate.

Possible Causes	What to Check and Suggested Measures
(1) No power supplied to the inverter.	<p>Check the input voltage, output voltage and interphase voltage unbalance.</p> <ul style="list-style-type: none"><li>→ Turn ON a molded case circuit breaker (MCCB), a residual-current-operated protective device (RCD)/a ground fault circuit interrupter (GFCI) (with overcurrent protection) or a magnetic contactor (MC).</li><li>→ Check for voltage drop, phase loss, poor connections, or poor contacts, and fix them if necessary.</li></ul>
(2) No forward/reverse operation command was inputted, or both the commands were inputted simultaneously (external signal operation).	<p>Check the input status of the forward/reverse command with Menu #4 "I/O Checking" using the keypad.</p> <ul style="list-style-type: none"><li>→ Input a run command.</li><li>→ Set either the forward or reverse operation command to off if both commands are being inputted.</li><li>→ Correct the assignment of commands <b>FWD</b> and <b>REV</b> to function codes E98 and E99.</li><li>→ Connect the external circuit wires to control circuit terminals [FWD] and [REV] correctly.</li><li>→ Make sure that the sink/source slide switch on the interface printed circuit board (interface PCB) is properly configured.</li></ul>
(3) No indication of rotation direction (keypad operation).	<p>Check the input status of the forward/reverse rotation direction command with Menu #4 "I/O Checking" using the keypad.</p> <ul style="list-style-type: none"><li>→ Input the rotation direction (F02 = 0), or select the keypad operation with which the rotation direction is fixed (F02 = 2 or 3).</li></ul>
(4) The inverter could not accept any run commands from the keypad since it was in Programming mode.	<p>Check which operation mode the inverter is in, using the keypad.</p> <ul style="list-style-type: none"><li>→ Shift the operation mode to Running mode and enter a run command.</li></ul>
(5) A run command with higher priority than the one attempted was active, and the run command was stopped.	<p>While referring to the block diagram of the drive command block*, check the higher priority run command with Menu #2 "Data Checking" and Menu #4 "I/O Checking" using the keypad.</p> <p>*Refer to the FRENIC-Multi User's Manual, Chapter 4.</p> <ul style="list-style-type: none"><li>→ Correct any incorrect function code data settings (in H30, y98, etc.) or cancel the higher priority run command.</li></ul>
(6) The frequency command was set below the starting or stop frequency.	<p>Check that a frequency command has been entered, with Menu #4 "I/O Checking" using the keypad.</p> <ul style="list-style-type: none"><li>→ Set the value of the frequency command to the same or higher than that of the starting or stop frequency (F23 or F25).</li><li>→ Reconsider the starting and stop frequencies (F23 and F25), and if necessary, change them to lower values.</li><li>→ Inspect the frequency command, signal converters, switches, or relay contacts. Replace any ones that are faulty.</li><li>→ Connect the external circuit wires correctly to terminals [13], [12], [11], and [C1].</li></ul>

Possible Causes	What to Check and Suggested Measures
(7) A frequency command with higher priority than the one attempted was active.	<p>Check the higher priority run command with Menu #2 "Data Checking" and Menu #4 "I/O Checking" using the keypad, referring to the block diagram of the drive command block*.</p> <p>*Refer to the FRENIC-Multi User's Manual, Chapter 4.</p> <p>→ Correct any incorrect function code data settings (e.g. cancel the higher priority run command).</p>
(8) The upper and lower frequencies for the frequency limiters were set incorrectly.	<p>Check the data of function codes F15 (Frequency limiter (high)) and F16 (Frequency limiter (low)).</p> <p>→ Change the settings of F15 and F16 to the correct ones.</p>
(9) The coast-to-stop command was effective.	<p>Check the data of function codes E01, E02, E03, E04, E05, E98 and E99 and the input signal status with Menu #4 "I/O Checking" using the keypad.</p> <p>→ Release the coast-to-stop command setting.</p>
(10) Broken wire, incorrect connection or poor contact with the motor.	<p>Check the cabling and wiring (Measure the output current).</p> <p>→ Repair the wires to the motor, or replace them.</p>
(11) Overload	<p>Measure the output current.</p> <p>→ Lighten the load (In winter, the load tends to increase.)</p> <p>Check that a mechanical brake is in effect.</p> <p>→ Release the mechanical brake, if any.</p>
(12) Torque generated by the motor was insufficient.	<p>Check that the motor starts running if the value of torque boost (F09 and A05) is increased.</p> <p>→ Increase the value of torque boost (F09 and A05) and try to run the motor.</p> <p>Check the data of function codes F04, F05, H50 through H53, A02, and A03.</p> <p>→ Change the V/f pattern to match the motor's characteristics.</p> <p>Check that the motor switching signal (selecting the motor 2 or 1) is correct and the data of function codes matches each motor.</p> <p>→ Correct the motor switching signal.</p> <p>→ Modify function codes to match the connected motor.</p> <p>Check whether the frequency command signal is below the slip-compensated frequency of the motor.</p> <p>→ Change the frequency command signal so that it becomes higher than the slip-compensated frequency of the motor.</p>
(13) Miss-/poor-connection of the DC reactor (DCR)	<p>Check the wiring.</p> <p>→ Connect the DC reactor correctly. Repair or replace wires for the DC reactor.</p>





## [ 2 ] The motor rotates, but the speed does not increase.

Possible Causes	What to Check and Suggested Measures
(1) The maximum frequency currently specified was too low.	<p>Check the data of function codes F03 and A01 (Maximum frequency).</p> <p>→ Readjust the data of F03 and A01.</p>
(2) The data of frequency limiter currently specified was too low.	<p>Check the data of function code F15 (Frequency limiter (high)).</p> <p>→ Readjust the data of (F15).</p>
(3) The reference frequency currently specified was too low.	<p>Check the signals for the frequency command from the analog input terminals with Menu #4 "I/O Checking" on the keypad.</p> <p>→ Increase the frequency of the command.</p> <p>→ If an external potentiometer for frequency command, signal converter, switches, or relay contacts are malfunctioning, replace them.</p> <p>→ Connect the external circuit wires to terminals [13], [12], [11], and [C1] correctly.</p>
(4) A frequency command (e.g., multi-frequency or via communications) with higher priority than the one expected was active and its reference frequency was too low.	<p>Check the data of the relevant function codes and what frequency commands are being received, through Menu #1 "Data Setting," Menu #2 "Data Checking" and Menu #4 "I/O Checking," on the keypad by referring to the block diagram of the frequency command*.</p> <p>*Refer to the FRENIC-Multi User's Manual, Chapter 4.</p> <p>→ Correct any incorrect data of function code (e.g. cancel higher priority run commands, etc.).</p>
(5) The acceleration time was too long or too short.	<p>Check the data of function codes F07 and E10 (Acceleration time).</p> <p>→ Change the acceleration time to match the load.</p>
(6) Overload	<p>Measure the output current.</p> <p>→ Lighten the load (Adjust the dumper of the fan or the valve of the pump). (In winter, the load tends to increase.)</p>
	<p>Check if mechanical brake is working.</p> <p>→ Release the mechanical brake.</p>
(7) Mismatch with the characteristics of the motor	<p>In case auto-torque boost or auto-energy saving operation is under way, check whether P02, P03, P06, P07, and P08 (A16, A17, A20, A21, and A22) agree with the parameters of the motor.</p> <p>→ Perform auto-tuning of the inverter for every motor to be used.</p>
(8) The current limiting operation did not increase the output frequency.	<p>Make sure that F43 (Current limiter (mode selection)) is set to "2" and check the setting of F44 (Current limiter (level)).</p> <p>→ Readjust the data of F44, or set F43 to "0" (disabled) if the current limiting operation is not functioning.</p>
	<p>Decrease the value of torque boost (F09), then run the motor again and check if the speed increases.</p> <p>→ Adjust the value of the torque boost (F09).</p>
	<p>Check the data of function codes F04, F05, H50 through H53 to ensure that the V/f pattern is right.</p> <p>→ Match the V/f pattern values with the motor ratings.</p>



Possible Causes	What to Check and Suggested Measures
(9) In the torque control mode, the output frequency does not increase.	<p>Check whether data of torque limiter related function codes (F40, F41, E16 and E17) is correctly configured and the torque limit switching signal <b>TL2/TL1</b> is correct.</p> <p>→ Reconfigure data of F40, F41, E16 and E17 correctly or reset it to the factory default.</p> <p>→ Switch correctly the torque switching terminal command <b>TL2/TL1</b>.</p>
(10) Bias and gain set incorrectly.	<p>Check the data of function codes F18, C50, C32, C34, C37, C39, C42, and C44.</p> <p>→ Readjust the bias and gain to appropriate values.</p>

### [ 3 ] The motor runs in the opposite direction to the command.



Possible Causes	What to Check and Suggested Measures
(1) Wiring has been connected to the motor incorrectly.	<p>Check the wiring to the motor.</p> <p>→ Connect terminals U, V, and W of the inverter to the respective U, V, and W terminals of the motor.</p>
(2) Incorrect connection and settings for run commands and rotation direction command <b>FWD</b> and <b>REV</b>	<p>Check the data of function codes E98 and E99 and the connection to terminals [FWD] and [REV].</p> <p>→ Correct the data of the function codes and the connection.</p>
(3) The setting for the rotation direction via keypad operation is incorrect.	<p>Check the data of function code F02 (Run command).</p> <p>→ Change the data of function code F02 to "2:  /  keys on keypad (forward)" or "3:  /  keys on keypad (reverse)."</p>

### [ 4 ] If the speed variation and current vibration (such as hunting) occur at the constant speed

Possible Causes	What to Check and Suggested Measures
(1) The frequency command fluctuated.	<p>Check the signals for the frequency command with Menu #4 "I/O Checking" using the keypad.</p> <p>→ Increase the filter constants (C33, C38, and C43) for the frequency command.</p>
(2) The external frequency command device was used.	<p>Check that there is no noise in the control signal wires from external sources.</p> <p>→ Isolate the control signal wires from the main circuit wires as far as possible.</p> <p>→ Use shielded or twisted wires for the control signal.</p> <p>Check whether the frequency command has not failed because of noise from the inverter.</p> <p>→ Connect a capacitor to the output terminal of the frequency command or insert a ferrite core in the signal wire. (Refer to Chapter 2, Section 2.3.6 "Wiring for control circuit terminals.")</p>

Possible Causes	What to Check and Suggested Measures
(3) Frequency switching or multi-frequency command was enabled.	<p>Check whether the relay signal for switching the frequency command is chattering.</p> <p>→ If the relay has a contact problem, replace the relay.</p>
(4) The connection between the inverter and the motor was too long.	<p>Check whether auto-torque boost or auto-energy saving operation is enabled.</p> <p>→ Perform auto-tuning of the inverter for every motor to be used.</p> <p>→ Enable load selection for higher startup torque (F37, A13 = 1) and check for any vibration.</p> <p>→ Make the output wire as short as possible.</p>
(5) The inverter output is hunting due to vibration caused by low stiffness of the load. Or the current is irregularly oscillating due to special motor parameters.	<p>Once cancel all the automatic control systems--auto torque boost, auto energy saving operation, overload prevention control, current limiter, torque limiter, regenerative energy suppression, auto search for idling motor speed, slip compensation, torque vector control, and droop control, overload stop function, then check that the motor vibration comes to a stop.</p> <p>→ Cancel the functions causing the vibration.</p> <p>→ Readjust the data of the output current fluctuation damping gain (H80 and A41).</p>
	<p>Check that the motor vibration is suppressed if you decrease the level of F26 (Motor sound (Carrier frequency)) or set F27 (Motor sound (Tone)) to "0."</p> <p>→ Decrease the carrier frequency (F26) or set the tone to "0" (F27 = 0).</p>

#### [ 5 ] If grating sound can be heard from motor

Possible Causes	What to Check and Suggested Measures
(1) The carrier frequency was set too low.	<p>Check the data of function codes F26 (Motor sound (Carrier frequency)) and F27 (Motor sound (Tone)).</p> <p>→ Increase the carrier frequency (F26).</p> <p>→ Readjust the setting of F27 to appropriate value.</p>
(2) The ambient temperature of the inverter was too high (when automatic lowering of the carrier frequency was enabled by H98).	<p>Measure the temperature inside the panel of the inverter.</p> <p>→ If it is over 40°C, lower it by improving the ventilation.</p> <p>→ Lower the temperature of the inverter by reducing the load. (In the case of a fan or a pump, lower the setting data of the frequency limiter (F15).)</p> <p><b>Note:</b> If you disable H98, an  or  alarm may occur.</p>
(3) Resonance with the load	<p>Check the precision of the mounting of the load or check whether there is resonance with the panel or likes.</p> <p>→ Disconnect the motor and run it without the inverter, and determine where the resonance comes from. Upon locating the cause, improve the characteristics of the source of the resonance.</p> <p>→ Adjust the settings of C01 (Jump frequency 1) to C04 (Jump frequency (Hysteresis width)) so as to avoid continuous running in the frequency range causing resonance.</p>

**[ 6 ] The motor does not accelerate and decelerate at the set time.**

Possible Causes	What to Check and Suggested Measures
(1) The inverter ran the motor by S-curve or curvilinear pattern.	<p>Check the data of function code H07 (Acceleration/deceleration pattern).</p> <ul style="list-style-type: none"> <li>➔ Select the linear pattern (H07 = 0).</li> <li>➔ Shorten the acceleration/deceleration time (F07, F08, E10 and E11).</li> </ul>
(2) The current limiting prevented the output frequency from increasing (during acceleration).	<p>Make sure that F43 (Current limiter (Mode selection)) is set to "2: Enable during acceleration and at constant speed," then check that the setting of F44 (Current limiter (Level)) is reasonable.</p> <ul style="list-style-type: none"> <li>➔ Readjust the setting of F44 to appropriate value, or disable the function of current limiter in F43.</li> <li>➔ Increase the acceleration/deceleration time (F07, F08, E10 and E11).</li> </ul>
(3) The automatic regenerative braking was active (during deceleration).	<p>Check the data of function code H69 (Automatic deceleration).</p> <ul style="list-style-type: none"> <li>➔ Increase the deceleration time (F08 and E11).</li> </ul>
(4) Overload	<p>Measure the output current.</p> <ul style="list-style-type: none"> <li>➔ Lighten the load (In the case of a fan or a pump load, lower the setting data of the F15 (Frequency limiter (High)). (In winter, the load tends to increase.).</li> </ul>
(5) Torque generated by the motor was insufficient.	<p>Check that the motor starts running if the value of the torque boost (F09 and A05) is increased.</p> <ul style="list-style-type: none"> <li>➔ Increase the value of the torque boost (F09 and A05).</li> </ul>
(6) An external frequency command is being used.	<p>Check that there is no noise in the external signal wires.</p> <ul style="list-style-type: none"> <li>➔ Isolate the control signal wires from the main circuit wires as far as possible.</li> <li>➔ Use shielded wire or twisted wire for the control signal wires.</li> <li>➔ Connect a capacitor to the output terminal of the frequency command or insert a ferrite core in the signal wire. (Refer to Chapter 2, Section 2.3.6 "Wiring for control circuit terminals.")</li> </ul>
(7) In torque limit operation, the acceleration/ deceleration is suppressed.	<p>Check whether data of torque limiter related function codes (F40, F41, E16 and E17) is correctly configured and the torque switching signal <b>TL2/TL1</b> is correct.</p> <ul style="list-style-type: none"> <li>➔ Reconfigure data of F40, F41, E16 and E17 correctly or reset it to the factory default.</li> <li>➔ Switch correctly the torque switching terminal command <b>TL2/TL1</b>.</li> <li>➔ Lengthen the acceleration/deceleration time (F07, F08, E10 and E11).</li> </ul>
(8) Any acceleration/ deceleration time is invalidly set.	<p>The terminal command <b>RT1</b> switching between the acceleration/ deceleration time 2 and 1 turns ON/OFF invalidly.</p> <ul style="list-style-type: none"> <li>➔ Turn the <b>RT1</b> ON/OFF validly. For reference, if <b>RT1</b> is ON, the acceleration/deceleration time 2 is applied.</li> </ul>

**[ 7 ] Even if the power recovers after a momentary power failure, the motor does not restart.**

Possible Causes	What to Check and Suggested Measures
(1) The data of function code F14 is either "0" or "1."	Check if an undervoltage trip occurs. → Change the data of function code F14 (Restart mode after momentary power failure (Mode selection)) to "4" or "5."
(2) The run command stayed off even after power has been restored.	Check the input signal with Menu #4 "I/O Checking" using the keypad. → Check the power recovery sequence with an external circuit. If necessary, consider the use of a relay that can keep the run command on.  While in 3-wire operation, the power source to the inverter's control PCB went down because of a long momentary power failure; or, the (HOLD) signal was turned OFF once. → Change the design or the setting so that a run command can be issued again within 2 seconds after power has been restored.

**[ 8 ] The inverter does not run as expected**

Possible Causes	What to Check and Suggested Measures
(1) Wrong configuration of function codes	Check that all function codes are correctly configured. → Correct the configuration of the function codes.  Make a note of function code data currently configured and initialize all function code data (H03). → After initialization, reconfigure the necessary function codes one by one, checking the running status of the inverter.

**6.2.2 Problems with inverter settings****[ 1 ] Nothing appears on the LED monitor.**



Possible Causes	What to Check and Suggested Measures
(1) No power supplied to the inverter.	Check the input voltage, output voltage and interphase voltage unbalance. → Connect a molded case circuit breaker (MCCB), a residual-current-operated protective device (RCD)/a ground fault circuit interrupter (GFCI)(with overcurrent protection) or a magnetic contactor (MC). → Check for voltage drop, phase loss, poor connections, or poor contacts, and fix them if necessary.
(2) The power for the control PCB did not reach a high enough level.	Check if the jumper bar has been removed between terminals P1 and P(+) or if there is poor contact between the jumper bar and the terminals. → Connect the jumper bar or DC reactor between terminals P1 and P(+) or retighten the screws.

Possible Causes	Check and Measures
(3) The keypad was not properly connected to the inverter.	<p>Check whether the keypad is properly connected to the inverter.</p> <p>→ Remove the keypad, put it back, and see whether the problem persists.</p> <p>→ Replace the keypad with another one and check whether the problem persists.</p>
	<p>When running the inverter remotely, ensure that the extension cable is securely connected both to the keypad and to the inverter.</p> <p>→ Disconnect the cable, reconnect it, and see whether the problem persists.</p> <p>→ Replace the keypad with another one and check whether the problem persists.</p>

## [ 2 ] The desired menu is not displayed.

Possible Causes	Check and Measures
(1) The limiting menus function was not selected appropriately.	<p>Check the data of function code E52 (Keypad (Menu display mode)).</p> <p>→ Change the data of function code E52 so that the desired menu can be displayed.</p>

## [ 3 ] Data of function codes cannot be changed

Possible Causes	What to Check and Suggested Measures
(1) An attempt was made to change function code data that cannot be changed when the inverter is running.	<p>Check if the inverter is running with Menu #3 "Drive Monitoring" using the keypad and then confirm whether the data of the function codes can be changed when the motor is running by referring to the function code tables.</p> <p>→ Stop the motor then change the data of the function codes.</p>
(2) The data of the function codes is protected.	<p>Check the data of function code F00 (Data Protection).</p> <p>→ Change the setting of F00 from "1" or "3" to "0" or "2."</p>
(3) The <b>WE-KP</b> command ("Enable data change with keypad") is not input though it has been assigned to a digital input terminal.	<p>Check the data of function codes E01, E02, E03, E04, E05, E98 and E99 and the input signals with Menu #4 "I/O Checking" using the keypad.</p> <p>→ Input a <b>WE-KP</b> command through a digital input terminal.</p>
(4) The  key was not pressed.	<p>Check whether you have pressed the  key after changing the function code data.</p> <p>→ Press the  key after changing the function code data.</p>
(5) The setting data of function code F02, E01 through E05, E98, and E99 could not be changed.	<p>The inputs to the terminals of <b>FWD</b> and <b>REV</b> commands are concurrently turned ON.</p> <p>→ Turn OFF both <b>FWD</b> and <b>REV</b>.</p>

### 6.3 If an Alarm Code Appears on the LED Monitor

■ Quick reference table of alarm codes

Alarm code	Name	Refer to	Alarm code	Name	Refer to
<i>OC 1</i>	Instantaneous overcurrent	6-10	<i>OL 1</i>	Electronic thermal overload alarm 1	6-17
<i>OC 2</i>			<i>OL 2</i>	Electronic thermal overload alarm 2	
<i>OC 3</i>			<i>OLU</i>	Overload	6-17
			<i>Er 1</i>	Memory error	6-18
<i>OU 1</i>	Overvoltage	6-11	<i>Er 2</i>	Keypad communications error	6-19
<i>OU 2</i>			<i>Er 3</i>	CPU error	6-19
<i>OU 3</i>			<i>Er 4</i>	Option card communications error	6-19
<i>LU</i>	Undervoltage	6-12	<i>Er 5</i>	Option card error	6-19
<i>L in</i>	Input phase loss	6-13	<i>Er 6</i>	Operation protection	6-20
<i>OPL</i>	Output phase loss	6-14	<i>Er 7</i>	Tuning error	6-20
<i>OH 1</i>	Heat sink overheat	6-14	<i>Er 8</i> <i>Er P</i>	RS-485 communications error RS-485 communications error (Option card)	6-21
<i>OH 2</i>	Alarm issued by an external device	6-15	<i>Er F</i>	Data saving error during undervoltage	6-22
<i>OH 4</i>	Motor protection (PTC thermistor)	6-15	<i>Er H</i>	Hardware error	6-23
<i>ObH</i>	Braking resistor overheated	6-16	<i>Err</i>	Mock alarm	6-23
			<i>LoF</i>	PID feedback wire break	6-23

#### [ 1 ] *OCn* Instantaneous overcurrent

Problem The inverter momentary output current exceeded the overcurrent level.

*OC 1* Overcurrent occurred during acceleration.

*OC 2* Overcurrent occurred during deceleration.

*OC 3* Overcurrent occurred when running at a constant speed.

Possible Causes	What to Check and Suggested Measures
(1) The inverter output terminals were short-circuited.	<p>Remove the wires connected to the inverter output terminals (U, V, and W) and measure the interphase resistance of the wires. Check if the resistance is too low.</p> <p>➔ Remove the part that short-circuited (including replacement of the wires, relay terminals and motor).</p>

Possible Causes	What to Check and Suggested Measures
(2) Ground faults occurred at the inverter output terminals.	Remove the wires connected to the inverter output terminals (U, V, and W) and perform a Megger test. → Remove the part that short-circuited (including replacement of the wires, relay terminals and motor).
(3) Loads were too heavy.	Measure the motor current with a measuring device, and to trace the current trend. Therefore, use this information to judge if the trend is over the calculated load value for your system design. → If the load is too heavy, decrease it or raise the inverter capacity.
	Trace the current trend and check if there are any sudden changes in the current. → If there are any sudden changes, make the load variation smaller or raise the inverter capacity. → Enable instantaneous overcurrent limiting (H12 = 1).
(4) The value set for torque boost (F09) was too large. (F37, A13 = 0, 1, 3, or 4)	Check that the output current decreases and the motor does not come to stall if you set a lower value than the current one for F09 and A05. → Lower the value for torque boost (F09 and A05.) if the motor is not going to stall.
(5) The acceleration/ deceleration time was too short.	Check that the motor generates enough torque required during acceleration/deceleration. That torque is calculated from the moment of inertia for the load and the acceleration/deceleration time. → Increase the acceleration/deceleration time (F07, F08, E10, E11, and H56). → Enable current limiter (F43) and torque limiter (F40 and F41) → Raise the inverter capacity.
(6) Malfunction caused by noise	Check if noise control measures are appropriate (e.g., correct grounding and routing of control and main circuit wires). → Implement noise control measures. For details, refer to "Appendix A" of the FRENIC-Multi User's Manual. → Enable the Auto-reset (H04). → Connect a surge absorber to the coil or solenoid of the magnetic contactor causing the noise.

## [ 2 ] *OVh* Overvoltage

Problem The DC link bus voltage was over the detection level of overvoltage.

*OV1* Overvoltage occurs during the acceleration.

*OV2* Overvoltage occurs during the deceleration.

*OV3* Overvoltage occurs during running at constant speed.

Possible Causes	What to Check and Suggested Measures
(1) The power supply voltage was over the range of the inverter's specifications.	Measure the input voltage. → Decrease the voltage to within that of the specifications.

Possible Causes	What to Check and Suggested Measures
(2) A surge current entered the input power supply.	<p>If within the same power supply a phase-advancing capacitor is turned ON or OFF or a thyristor converter is activated, a surge (temporary precipitous rise in voltage or current) may be caused in the input power.</p> <p>→ Install a DC reactor.</p>
(3) The deceleration time was too short for the moment of inertia for load.	<p>Recalculate the deceleration torque from the moment of inertia for load and the deceleration time.</p> <p>→ Increase the deceleration time (F08, E11, and H56).</p> <p>→ Enable the regenerative braking (H69 = 2, 4), or deceleration characteristics (H71 = 1).</p> <p>→ Enable torque limiter (F41).</p> <p>→ Set the rated voltage (at base frequency) (F05 and A03) to "0" to improve braking ability.</p>
(4) The acceleration time was too short.	<p>Check if the overvoltage alarm occurs after rapid acceleration.</p> <p>→ Increase the acceleration time (F07 and E10).</p> <p>→ Select the S-curve pattern (H07).</p>
(5) Braking load was too heavy.	<p>Compare the braking torque of the load with that of the inverter.</p> <p>→ Set the rated voltage (at base frequency) (F05 and A03) to 0 to improve braking ability.</p>
(6) Malfunction caused by noise.	<p>Check if the DC link bus voltage was below the protective level when the alarm occurred.</p> <p>→ Improve noise control. For details, refer to "Appendix A" of the FRENIC-Multi User's Manual.</p> <p>→ Enable the Auto-reset (H04).</p> <p>→ Connect a surge absorber to the coil or solenoid of the magnetic contactor causing the noise.</p>

### [ 3 ] $\mathcal{L}\mathcal{L}$ Undervoltage

Problem DC link bus voltage was below the undervoltage detection level.

Possible Causes	What to Check and Suggested Measures
(1) A momentary power failure occurred.	<p>→ Reset the alarm.</p> <p>→ If you want to restart running the motor by not treating this condition as an alarm, set F14 to "4" or "5," depending on the load.</p>
(2) The power to the inverter was switched back on too soon (with F14 = 1).	<p>Check if the power to the inverter was switched back on although its control PCB was still operating. (Check whether the LEDs on the keypad light.)</p> <p>→ Switch the power ON again after all LEDs on the keypad go off.</p>
(3) The power supply voltage did not reach the range of the inverter's specifications.	<p>Measure the input voltage.</p> <p>→ Increase the voltage to within that of the specifications.</p>



Possible Causes	What to Check and Suggested Measures
(4) Peripheral equipment for the power circuit malfunctioned, or the connection was incorrect.	Measure the input voltage to find where the peripheral equipment malfunctioned or which connection is incorrect. → Replace any faulty peripheral equipment, or correct any incorrect connections.
(5) Other loads were connected to the same power supply and required a large current to start running to the extent that it caused a temporary voltage drop on the supply side.	Measure the input voltage and check the voltage variation. → Reconsider the power system configuration.
(6) Inverter's inrush current caused the power voltage drop because power supply transformer capacity was insufficient.	Check if the alarm occurs when you switch on a molded case circuit breaker (MCCB), a residual-current-operated protective device (RCD)/a ground fault circuit interrupter (GFCI) (with overcurrent protection) or a magnetic contactor (MC). → Reconsider the capacity of the power supply transformer.

#### [ 4 ] ⚡ ↻ Input phase loss

**Problem** Input phase loss occurred, or interphase voltage unbalance rate was large.

Possible Causes	What to Check and Suggested Measures
(1) Main circuit power input wires broken.	Measure the input voltage. → Repair or replace the wires.
(2) The terminal screws for the main circuit power input of the inverter were not tight enough.	Check if the screws on the inverter input terminals have become loose. → Tighten the terminal screws to the recommended torque.
(3) Interphase unbalance rate of three-phase voltage was too large.	Measure the input voltage. → Connect an AC reactor (ACR) to lower the voltage unbalance between input phases. → Raise the inverter capacity.
(4) Overload cyclically occurred.	Measure ripple wave of DC link bus voltage. → If the ripple is large, raise the inverter capacity.
(5) Single-phase voltage was input to the three-phase input inverter instead of three-phase voltage input.	Check the inverter type. → Apply three-phase power. FRENIC-Multi of three-phase input cannot be driven by single-phase power supply.



You can disable input phase loss protection using the function code H98 (Protection/Maintenance Function).

## [ 5 ] *DPL* Output phase loss

Problem      Output phase loss occurred.

Possible Causes	What to Check and Suggested Measures
(1) Inverter output wires are broken.	Measure the output current. → Replace the output wires.
(2) Wires for motor winding are broken.	Measure the output current. → Replace the motor.
(3) The terminal screws for inverter output were not tight enough.	Check if any screws on the inverter output terminals have become loose. → Tighten the terminal screws to the recommended torque.
(4) A single-phase motor has been connected.	→ Single-phase motors cannot be used. Note that the FRENIC-Multi only drives three-phase induction motors.

## [ 6 ] *DH* / Heat sink overheat

Problem      Temperature around heat sink rose.

Possible Causes	What to Check and Suggested Measures
(1) Temperature around the inverter exceeded that of inverter specifications.	Measure the temperature around the inverter. → Lower the temperature around the inverter (e.g., ventilate the panel well).
(2) Air vent is blocked.	Check if there is sufficient clearance around the inverter. → Increase the clearance.
	Check if the heat sink is not clogged. → Clean the heat sink.
(3) Accumulated running time of the cooling fan exceeded the standard period for replacement, or the cooling fan malfunctioned.	Check the cumulative running time of the cooling fan. Refer to Chapter 3, Section 3.4.6 "Reading maintenance information – "Maintenance Information"." → Replace the cooling fan.
	Visually check whether the cooling fan rotates abnormally. → Replace the cooling fan.
(4) Load was too heavy.	Measure the output current. → Lighten the load (e.g. lighten the load before the overload protection occurs using the overload early warning (E34). (In winter, the load tends to increase.) → Decrease the motor sound (carrier frequency) (F26). → Enable the overload prevention control (H70).

## [ 7 ] *OH2* Alarm issued by an external device

Problem External alarm was inputted (**THR**).  
(when "Enable external alarm trip" **THR** is assigned to one of digital input terminals [X1] through [X5], [FWD], and [REV])

Possible Causes	What to Check and Suggested Measures
(1) An alarm function of the external equipment was activated.	Inspect external equipment operation. → Remove the cause of the alarm that occurred.
(2) Connection has been performed incorrectly.	Check if the wire for the external alarm signal is correctly connected to the terminal to which the "Alarm from external equipment" has been assigned (Any of E01, E02, E03, E04, E05, E98, and E99 is set to "9"). → Connect the wire for the alarm signal correctly.
(3) Incorrect settings.	Check if the "Alarm from external equipment" has not been assigned to an unused terminal (E01, E02, E03, E04, E05, E98, or E99). → Correct the assignment.  Check whether the assignment (normal/negative logic) of the external signal agrees with that of thermal command <b>THR</b> set by E01, E02, E03, E04, E05, E98, and E99. → Ensure that the polarity matches.

## [ 8 ] *OH4* Motor protection (PTC thermistor)

Problem Temperature of the motor rose abnormally.

Possible Causes	What to Check and Suggested Measures
(1) Temperature around the motor exceeded that of motor specifications.	Measure the temperature around the motor. → Lower the temperature.
(2) Cooling system for the motor malfunctioned.	Check if the cooling system of the motor is operating normally. → Repair or replace the cooling system of the motor.
(3) Load was too heavy.	Measure the output current. → Lighten the load (e.g., lighten the load before overload occurs using E34 (Overload Early Warning). (In winter, the load tends to increase.). → Lower the temperature around the motor. → Increase the motor sound (carrier frequency) (F26).
(4) The set activation level (H27) of the PTC thermistor for motor overheat protection was inadequate.	Check the thermistor specifications and recalculate the detection voltage. → Reconsider the data of function code H27.
(5) A PTC thermistor and pull-up resistor were connected incorrectly or the resistance was inadequate.	Check the connection and the resistance of the pull-up resistor. → Correct the connections and replace the resistor with one with an appropriate resistance.

Possible Causes	What to Check and Suggested Measures
(6) The value set for the torque boost (F09 and A05) was too high.	Check the data of function codes F09 and A05 and readjust the data so that the motor does not stall even if you set the data to a lower value. → Readjust the data of the function codes F09 and A05.
(7) The V/f pattern did not match the motor.	Check if the base frequency (F04 and A02) and rated voltage at base frequency (F05 and A03) match the values on the nameplate on the motor. → Match the function code data to the values on the nameplate of the motor.
(8) Wrong settings	Although no PTC thermistor is used, the thermistor (H26) is active. → Set H26 (Thermistor (Mode selection)) to "0" (Disable).

### [ 9 ] *dbH* Braking resistor overheated

**Problem** The electronic thermal protection for the braking resistor has been activated.

Possible Causes	What to Check and Suggested Measures
(1) Braking load is too heavy.	Reconsider the relationship between the braking load estimated and the real load. → Lower the real braking load. → Review the performance of the current braking resistor and raise it (Modification of related function code data (F50 and F51) is also required.)
(2) Deceleration time currently specified is too short.	Re-estimate the deceleration torque and time needed for the current load with a moment of inertia and a deceleration time. → Lengthen the deceleration time (F08, E11 or H56). → Review the performance of the braking resistor and raise it. (Modification of related function code data (F50 and F51) is also required.)
(3) Wrong configuration of function codes F50 and F51.	Recheck the specifications of the braking resistor. → Review data of function codes F50 and F51, then reconfigure them.

**Note:** The inverter issues an overheat alarm of the braking resistor by monitoring the magnitude of the braking load, not by measuring its surface temperature.

Therefore, even if the surface temperature of the braking resistor does not rise, when the use of the brake exceeds more frequently than the one specified by function codes (F50 and 51), the inverter issues an overheat alarm. To squeeze out full performance of the braking resistor, configure data of function codes F50 and F51 while actually measuring the surface temperature of the braking resistor.

[ 10 ] **OL1** / **Electronic thermal overload alarm 1**  
**OL2** / **Electronic thermal overload alarm 2**

Problem      Electronic thermal protection for motor 1 or motor 2 activated.

Possible Causes	What to Check and Suggested Measures
(1) The characteristics of electronic thermal did not match those of the motor overload.	Check the motor characteristics. → Reconsider the data of function codes (P99, F10 and F12) and (A39, A06 and A08). → Use an external thermal relay.
(2) Activation level for the electronic thermal relay was inadequate.	Check the continuous allowable current of the motor. → Reconsider and change the data of function codes F11 and A07.
(3) The acceleration/ deceleration time was too short.	Check that the motor generates enough torque for acceleration/ deceleration. This torque is calculated from the moment of inertia for the load and the acceleration/ deceleration time. → Increase the acceleration/ deceleration time (F07, F08, E10, E11, and H56).
(4) Load was too heavy.	Measure the output current. → Lighten the load (e.g., lighten the load before overload occurs using E34 (Overload Early Warning). (In winter, the load tends to increase.)

[ 11 ] **OLU** / **Overload**



Problem      Temperature inside inverter rose abnormally.

Possible Causes	What to Check and Suggested Measures
(1) Temperature around the inverter exceeded that of inverter specifications.	Measure the temperature around the inverter. → Lower the temperature (e.g., ventilate the panel well).
(2) The torque boost setting (F09 and A05) was too high.	Check the setting of F09 and A05 (Torque Boost) and make sure that lowering it would not cause the motor to stall. → Adjust the setting of F09 and A05.
(3) The acceleration/ deceleration time was too short.	Recalculate the required acceleration/deceleration torque and time from the moment of inertia for the load and the deceleration time. → Increase the acceleration/deceleration time (F07, F08, E10, E11, and H56).
(4) Load was too heavy.	Measure the output current. → Lighten the load (e.g., lighten the load before overload occurs using the overload early warning (E34)). (In winter, the load tends to increase.) → Decrease the motor sound (carrier frequency) (F26). → Enable overload prevention control (H70).
(5) Air vent is blocked.	Check if there is sufficient clearance around the inverter. → Increase the clearance. Check if the heat sink is not clogged. → Clean the heat sink.

Possible Causes	What to Check and Suggested Measures
(6) The service life of the cooling fan has expired or the cooling fan malfunctioned.	Check the cumulative running time of cooling fan. Refer to Chapter 3, Section 3.4.6 "Reading maintenance information – "Maintenance Information"." → Replace the cooling fan.
	Visually check that the cooling fan rotates normally. → Replace the cooling fan.
(7) The wires to the motor are too long and caused a large amount of current to leak from them.	Measure the leakage current. → Insert an output circuit filter (OFL).

## [ 12 ] *E<sub>r</sub>* / Memory error

Problem Error occurred in writing the data to the memory in the inverter.

Possible Causes	What to Check and Suggested Measures
(1) While the inverter was writing data (especially initializing data or copying data), power supply was turned OFF and the voltage for the control PCB dropped.	Check if pressing the  key resets the alarm after the function code data are initialized by setting the data of H03 to "1." → Return the initialized function code data to their previous settings, then restart the operation.
(2) A high intensity noise was given to the inverter while data (especially initializing data) was being written.	Check if appropriate noise control measures have been implemented (e.g., correct grounding and routing of control and main circuit wires). Also, perform the same check as described in (1) above. → Improve noise control. Alternatively, return the initialized function code data to their previous settings, then restart the operation.
(3) The control PCB failed.	Initialize the function code data by setting H03 to "1," then reset the alarm by pressing the  key and check that the alarm goes on. → The control PCB (on which the CPU is mounted) is defective. Contact your Fuji Electric representative.

### [ 13 ] *E<sub>r</sub>-2* Keypad communications error

**Problem** A communications error occurred between the standard keypad or the multi-function keypad and the inverter.

Possible Causes	What to Check and Suggested Measures
(1) Break in the communications cable or poor contact.	Check continuity of the cable, contacts and connections. → Re-insert the connector firmly. → Replace the cable.
(2) A high intensity noise was given to the inverter.	Check if appropriate noise control measures have been implemented (e.g., correct grounding and routing of control and main circuit wires). → Improve noise control. For details, refer to "Appendix A" of the FRENIC-Multi User's Manual.
(3) The keypad malfunctioned.	Check that alarm <i>E<sub>r</sub>-2</i> does not occur if you connect another keypad to the inverter. → Replace the keypad.

### [ 14 ] *E<sub>r</sub>-3* CPU error

**Problem** A CPU error (e.g. erratic CPU operation) occurred.

Possible Causes	What to Check and Suggested Measures
(1) A high intensity noise was given to the inverter.	Check if appropriate noise control measures have been implemented (e.g. correct grounding and routing of control and main circuit wires and communications cable). → Improve noise control.

### [ 15 ] *E<sub>r</sub>-4* Option card communications error

**Problem** A communications error occurred between the option card and the inverter.

Possible Causes	What to Check and Suggested Measures
(1) There was a problem with the connection between the option card and the inverter.	Check whether the connector on the option card is properly mating with the connector of the inverter. → Reload the bus option card into the inverter.
(2) There was a high intensity noise from outside.	Check whether appropriate noise control measures have been implemented (e.g. correct grounding and routing of control and main circuit wires and communications cable). → Reinforce noise control measures.

### [ 16 ] *E<sub>r</sub>-5* Option card error

An error detected by the option card. Refer to the instruction manual of the option card for details.

## [ 17 ] *E-5* Operation protection

Problem You incorrectly operated the inverter.

Possible Causes	What to Check and Suggested Measures
(1) The  key was pressed when H96 = 1 or 3.	Although a Run command had been inputted from the input terminal or through the communications port, the inverter was forced to decelerate to stop. → If this was not intended, check the setting of H96.
(2) The start check function was activated when H96 = 2 or 3.	With a Run command being inputted, any of the following operations has been performed: - Turning the power ON - Releasing the alarm - Switching the enable communications link <b>LE</b> operation → Review the running sequence to avoid input of a Run command when this error occurs. If this was not intended, check the setting of H96. (Turn the run command OFF before resetting the alarm.)
(3) The forced stop digital input <b>STOP</b> was turned ON.	Turning ON the forced stop digital input <b>STOP</b> decelerated the inverter to stop according to the specified deceleration period (H96). → If this was not intended, check the settings of E01 through E05 on terminals [X1] through [X5].

## [ 18 ] *E-7* Tuning error

Problem Auto-tuning failed.

Possible Causes	What to Check and Suggested Measures
(1) A phase was missing (There was a phase loss) in the connection between the inverter and the motor.	→ Properly connect the motor to the inverter.
(2) V/f or the rated current of the motor was not properly set.	Check whether the data of function codes agrees with the specifications of the motor. Motor 1: F04, F05, H50 through H53, P02, and P03 Motor 2: A02, A03, A16, and A17
(3) The connection length between the inverter and the motor was too long.	Check whether the connection length between the inverter and the motor is not exceeding 50 m. → Review, and if necessary, change the layout of the inverter and the motor to shorten the connection wire. Alternatively, minimize the connection wire length without changing the layout. → Disable both auto-tuning and auto-torque boost (set data of F37 or A13 to "1").



Possible Causes	What to Check and Suggested Measures
(4) The rated capacity of the motor was significantly different from that of the inverter.	<p>Check whether the rated capacity of the motor is smaller than that of the inverter by three or more orders of class or larger by two or more orders of class.</p> <p>→ Check whether it is possible to replace the inverter with one with an appropriate capacity.</p> <p>→ Manually specify the values for the motor parameters P06, P07, and P08 or A20, A21, and A22.</p> <p>→ Disable both auto-tuning and auto-torque boost (set data of F37 or A13 to "1").</p>
(5) The motor was a special type such as a high-speed motor.	<p>→ Disable both auto-tuning and auto-torque boost (set data of F37 or A13 to "1").</p>
(6) A tuning operation involving motor rotation (P04 or A18 = 2) was attempted while the brake was applied to the motor.	<p>→ Specify the tuning that does not involve the motor rotation (P04 or A18 = 1).</p> <p>→ Release the brake before tuning that involves the motor rotation (P04 or A18 = 2).</p>



For details of tuning errors, refer to "Errors during Tuning" in Chapter 4, Section 4.1.3 "Preparation before running the motor for a test – Setting function code data."

### [ 19 ] *E<sub>r</sub>B* RS-485 communications error *E<sub>r</sub>P* RS-485 communications error (Option card)



**Problem** A communications error occurred during RS-485 communications.

Possible Causes	What to Check and Suggested Measures
(1) Conditions for communications differ between the inverter and host equipment.	<p>Compare the settings of the y codes (y01 to y10, y11 to y20) with those of the host equipment.</p> <p>→ Correct any settings that differ.</p>
(2) Even though no response error detection time (y08, y18) has been set, communications is not performed within the specified cycle.	<p>Check the host equipment.</p> <p>→ Change the settings of host equipment software, or make the no response error detection time be ignored (y08, y18 = 0).</p>
(3) Host equipment (e.g., PLCs and personal computers) did not operate due to incorrect settings and/or defective software/hardware.	<p>Check the host equipment.</p> <p>→ Remove the cause of the equipment error.</p>
(4) RS-485 converter did not operate due to incorrect connections and settings, or defective hardware.	<p>Check the RS-485 converter (e.g., check for poor contact).</p> <p>→ Change the various RS-485 converter settings, reconnect the wires, or replace hardware (such as recommended devices) as appropriate.</p>
(5) Broken communications cable or poor contact.	<p>Check continuity of the cable, contacts and connections.</p> <p>→ Replace the cable.</p>

Possible Causes	What to Check and Suggested Measures
(6) A high intensity noise was given to the inverter.	<p>Check if appropriate noise control measures have been implemented (e.g., correct grounding and routing of control and main circuit wires).</p> <ul style="list-style-type: none"> <li>➔ Improve noise control.</li> <li>➔ Improve noise reduction measures on the host side.</li> <li>➔ Replace the RS-485 relay converter with a recommended insulated converter.</li> </ul>
(7) The RS-485 communications card malfunctioned.	<ul style="list-style-type: none"> <li>➔ Replace the RS-485 communications card (option).</li> </ul>

## [ 20 ] *E-F* Data saving error during undervoltage

**Problem** The inverter failed to save data such as the frequency commands, PID commands, timer value for the timer operation (which are specified through the keypad) or the output frequencies modified by the **UP/DOWN** terminal commands when the power was switched OFF.

Possible Causes	What to Check and Suggested Measures
(1) The voltage fed to the control PCB dropped suddenly while data was being saved when the power was turned OFF, because the DC link bus was rapidly discharged.	<p>Check how long it takes for the DC link bus voltage to drop to the preset voltage when power is turned OFF.</p> <ul style="list-style-type: none"> <li>➔ Remove whatever is causing the rapid discharge of the DC link bus electricity. After pressing the  key and releasing the alarm, return the data of the relevant function codes (such as the frequency commands, PID commands, timer value for the timer driven operation (specified through the keypad) or the output frequencies modified by the <b>UP/DOWN</b> terminal commands) back to the original values and then restart the operation.</li> </ul>
(2) A high intensity noise affected the operation of the inverter while data was being saved when the power was turned OFF.	<p>Check if appropriate noise control measures have been implemented (e.g., correct grounding and routing of control and main circuit wires).</p> <ul style="list-style-type: none"> <li>➔ Improve noise control. After pressing the  key and releasing the alarm, return the data of the relevant function codes (such as the frequency commands, PID commands, timer value for the timer driven operation (specified through the keypad) or the output frequencies modified by the <b>UP/DOWN</b> terminal commands when the power was switched OFF) back to the original values and then restart the operation.</li> </ul>
(3) The control circuit failed.	<p>Check if <i>E-F</i> occurs each time power is switched ON.</p> <ul style="list-style-type: none"> <li>➔ The control PCB (on which the CPU is mounted) is defective. Contact your Fuji Electric representative.</li> </ul>

## [ 21 ] *E-rH* Hardware error

Problem Abnormality on the control PCB or related hardware.

Possible Causes	What to Check and Suggested Measures
(1) The interface PCB is wrongly mounted.	Remove the interface PCB once and remount it into the card slot until it clicks into place.
(2) The capacity is not set properly on the control PCB.	The inverter capacity needs to be modified again. → Contact your Fuji Electric representative.
(3) An abnormality is found in the interconnection between the control PCB, power PCB, and interface PCB.	Replacement of any boards with an hazard may be required. → Contact your Fuji Electric representative.
(4) Connection problem between the control PCB and the option card.	Either the control PCB or the option card needs to be replaced. → Contact your Fuji Electric representative.
(5) Terminals [13] and [11] are short-circuited with each other.	Check circuits/wires hooking terminals [13] and [11]. → Remove all the parts causing the short-circuit.

## [ 22 ] *E-r-r* Mock alarm

Problem The LED displays the alarm *E-r-r*.

Possible Causes	What to Check and Suggested Measures
(1) Data of the function code H45 has been set to "1."	This setting makes the inverter issue a mock alarm. Use this to check out the sequence related to an alarm occurrence. → To escape from this alarm state, press the  key.

## [ 23 ] *L-oF* PID feedback wire break

Problem The PID feedback wire is broken.

Possible Causes	What to Check and Suggested Measures
(1) The PID feedback signal wire is broken.	Check whether the PID feedback signal wires are connected correctly. → Check whether the PID feedback signal wires are connected correctly. Or, tighten up the related terminal screws. → Check whether any contact part bites the wire sheath.
(2) A high intensity noise was given to somewhere in PID feedback related circuits.	Check if appropriate noise control measures have been implemented (e.g., correct grounding and routing of signal wires, communication cables, and main circuit wires). → Improve the countermeasures against the noise. → Separate signal wires from main power wires as far as possible.

## 6.4 If an Abnormal Pattern Appears on the LED Monitor while No Alarm Code is Displayed

### [ 1 ] - - - - (center bar) appears

Problem A center bar (- - - -) has appeared on the LED monitor.

Possible Causes	What to Check and Suggested Measures
(1) Any of PID commands and their feedback related functions is disabled.	<p>Make sure that when you wish to view other monitor items, E43 is not set to "10: PID command" or "12: PID feedback amount."</p> <p>→ Set E43 to a value other than "10" or "12."</p> <p>Make sure that when you wish to view a PID command or a PID feedback amount, PID control is still in effect or J01 is not set to "0."</p> <p>→ Set J01 to "1: Enable (Process control normal operation)" or "2: Enable (Process control inverse operation)."</p>
(2) Connection to the keypad was in poor connection.	<p>Prior to proceed, check that pressing the  key does not take effect for the LED display.</p> <p>Check connectivity of the extension cable for the keypad used in remote operation.</p> <p>→ Replace the cable.</p>

### [ 2 ] \_ \_ \_ \_ (under bar) appears

Problem An under bar (\_ \_ \_ \_) appeared on the LED monitor when you pressed the  key or entered a run forward command **FWD** or a run reverse command **REV**. The motor did not start.

Possible Causes	What to Check and Suggested Measures
(1) The voltage of the DC link bus was low.	<p>Select <u>5_01</u> under Menu #5 "Maintenance Information" in Programming mode on the keypad, and check the voltage of the DC link bus, which should be: 200 VDC or below for three-phase 200 V, and 400 VDC or below for three-phase 400 V.</p> <p>→ Connect the inverter to a power supply that meets its input specifications.</p>

### [ 3 ] [ ] appears

Problem Parentheses ([ ]) has appeared on the LED monitor while the keypad displaying the Drive Monitor.

Possible Causes	What to Check and Suggested Measures
(1) The data to be displayed could not fit the LED monitor (e.g. overflow).	<p>Check that the product of the output frequency and the display coefficient (E50) does not exceed 9999.</p> <p>→ Adjust the setting of E50.</p>

## Chapter 7 MAINTENANCE AND INSPECTION

Perform daily and periodic inspection to avoid trouble and keep reliable operation for a long time. Take care of the following items during work.

### WARNING

- Before proceeding to the maintenance and inspection, turn OFF the power and wait more than five minutes. Make sure that the LED monitor is turned OFF. Further, make sure, using a multimeter or a similar instrument, that the DC link bus voltage between the terminals P (+) and N (-) has dropped below the safe voltage (+25 VDC).

**Electric shock may occur.**

- Maintenance, inspection, and parts replacement should be made only by authorized persons.
- Take off the watch, rings and other metallic matter before starting work.
- Use insulated tools.
- Never modify the inverter.

**Electric shock or injuries could occur.**

### 7.1 Daily Inspection

Visually inspect errors in the state of operation from the outside without removing the covers while the inverter operates or while it is turned ON.

- Check if the expected performance (satisfying the standard specification) is obtained.
- Check if the surrounding environment satisfies Chapter 2, Section 2.1 "Operating Environment."
- Check that the LED monitor displays normally.
- Check for abnormal noise, odor, or excessive vibration.
- Check for traces of overheating, discoloration and other defects.

### 7.2 Periodic Inspection

Perform periodic inspection by the following items of the list of periodic inspection in Table 7.1. Before performing periodic inspection, be sure to stop the motor, turn OFF the inverter, and shut down power supply. Then remove the covers of the control and main circuit terminal blocks.

Table 7.1 List of Periodic Inspections

Check part	Check item	How to inspect	Evaluation criteria
Environment	1) Check the ambient temperature, humidity, vibration and atmosphere (dust, gas, oil mist, or water drops).	1) Check visually or measure using apparatus.	1) The standard specification must be satisfied.
	2) Check if tools or other foreign materials or dangerous objects are left around the equipment.	2) Visual inspection	2) No foreign or dangerous objects are left.
Voltage	Check if the voltages of the main and control circuit are correct.	Measure the voltages using a multimeter or the like.	The standard specification must be satisfied.

Table 7.1 List of Periodic Inspections (Continued)

Check part	Check item	How to inspect	Evaluation criteria	
Keypad	<ol style="list-style-type: none"> <li>1) Check if the display is clear.</li> <li>2) Check if there is missing parts in the characters.</li> </ol>	<ol style="list-style-type: none"> <li>1), 2)</li> </ol> Visual inspection	<ol style="list-style-type: none"> <li>1), 2)</li> </ol> The display can be read and there is no fault.	
Structure such as frame and cover	<ol style="list-style-type: none"> <li>1) Abnormal noise and excessive vibration</li> <li>2) Loosen bolts (tightened parts)</li> <li>3) Deformation and breakage</li> <li>4) Discoloration and deformation caused by overheat</li> <li>5) Check for foulness and dust.</li> </ol>	<ol style="list-style-type: none"> <li>1) Visual or hearing inspection</li> <li>2) Retighten.</li> <li>3), 4), 5)</li> </ol> Visual inspection	<ol style="list-style-type: none"> <li>1), 2), 3), 4), 5)</li> </ol> No abnormalities	
Main circuit	Common	<ol style="list-style-type: none"> <li>1) Check if bolts and screws are tight and not missing.</li> <li>2) Check the devices and insulators for deformation, cracks, breakage and discoloration caused by overheat and deterioration.</li> <li>3) Check for foulness and dust.</li> </ol>	<ol style="list-style-type: none"> <li>1) Retighten.</li> <li>2), 3)</li> </ol> Visual inspection	<ol style="list-style-type: none"> <li>1), 2), 3)</li> </ol> No abnormalities
	Conductor and wire	<ol style="list-style-type: none"> <li>1) Check the conductor for discoloration and distortion caused by overheat.</li> <li>2) Check the sheath of the cable for cracks and discoloration.</li> </ol>	<ol style="list-style-type: none"> <li>1), 2)</li> </ol> Visual inspection	<ol style="list-style-type: none"> <li>1), 2)</li> </ol> No abnormalities
	Terminal block	Check that the terminals are not damaged.	Visual inspection	No abnormalities
	DC link bus capacitor	<ol style="list-style-type: none"> <li>1) Check for electrolyte leakage, discoloration, cracks and swelling of the case.</li> <li>2) Check if the safety valve does not protrude remarkably.</li> <li>3) Measure the capacitance if necessary.</li> </ol>	<ol style="list-style-type: none"> <li>1), 2)</li> <li>3) Measure discharge time with capacitance probe.</li> </ol> Visual inspection	<ol style="list-style-type: none"> <li>1), 2)</li> <li>3) The discharge time is not shorter than time specified by the replacement manual.</li> </ol> No abnormalities
	Braking resistor	<ol style="list-style-type: none"> <li>1) Check for odor caused by overheat and cracked insulator.</li> <li>2) Check for broken wire.</li> </ol>	<ol style="list-style-type: none"> <li>1) Smelling and visual inspection</li> <li>2) Visual inspection or measurement with multimeter under disconnection of one lead</li> </ol>	<ol style="list-style-type: none"> <li>1) No abnormalities</li> <li>2) Within <math>\pm 10\%</math> of the specified resistance</li> </ol>
	Transformer and reactor	Check for abnormal roaring noise and odor.	Hearing, visual and smelling inspection	No abnormalities
	Magnetic contactor and relay	<ol style="list-style-type: none"> <li>1) Check for chatters during operation.</li> <li>2) Check for rough contacts.</li> </ol>	<ol style="list-style-type: none"> <li>1) Hearing inspection</li> <li>2) Visual inspection</li> </ol>	<ol style="list-style-type: none"> <li>1), 2)</li> </ol> No abnormalities

Table 7.1 List of Periodic Inspections (Continued)

Check part		Check item	How to inspect	Evaluation criteria
Control circuit	Printed circuit board	1) Check for loose screws and connectors. 2) Check for odor and discoloration. 3) Check for cracks, breakage, deformation and remarkable rust. 4) Check the capacitors for electrolyte leaks and deformation.	1) Retighten. 2) Smelling and visual inspection 3), 4) Visual inspection	1), 2), 3), 4) No abnormalities
Cooling system	Cooling fan	1) Check for abnormal noise and excessive vibration.  2) Check for loose bolts. 3) Check for discoloration caused by overheat.	1) Hearing and visual inspection, or turn manually (be sure to turn the power OFF). 2) Retighten. 3) Visual inspection	1) Smooth rotation  2), 3) No abnormalities
	Ventilation path	Check the heat sink, intake and exhaust ports for clogging and foreign materials.	Visual inspection	No abnormalities

If the inverter is stained, wipe it off with a chemically neutral cloth to remove dust and use a vacuum cleaner.

### 7.3 List of Periodical Replacement Parts

Each part of the product has its own service life that will vary according to the environmental and operating conditions. It is recommended that the following parts be replaced as specified below.

When the replacement is necessary, consult your Fuji Electric representative.

Table 7.2 Replacement Parts

Part name	Standard replacement intervals
DC link bus capacitor	10 years
Electrolytic capacitors on the printed circuit boards	10 years
Cooling fan	10 years

(Note) These replacement intervals are based on the estimated service life of the inverter at an ambient temperature of 40°C (104°F) under 80% of full load. In environments with an ambient temperature above 40°C (104°F) or a large amount of dust or dirt, the replacement intervals may need to be reduced.

Standard replacement intervals mentioned above is only a guide for replacement, not a guaranteed service life.

### 7.3.1 Judgment on service life

#### (1) Viewing data necessary for judging service life; Measurement procedures

Through Menu #5 "Maintenance Information" in Programming mode, you can view on the keypad various data (as a guideline) necessary for judging whether key components such as the DC link bus capacitor, electrolytic capacitors on the printed circuit boards, and cooling fan are approaching their service life.

①-1 Measuring the capacitance of the DC link bus capacitor (in comparison with that at factory shipment)

Measure the capacitance of the DC link bus capacitor according to the procedure given below. The result will be displayed on the keypad as a ratio (%) to the initial capacitance at the time of factory shipment.

---

#### Procedure for measuring capacitance

---

- 1) To ensure validity in the comparative measurement, put the condition of the inverter back to the state at factory shipment.
  - Remove the option card (if already in use) from the inverter.
  - In case another inverter is connected via the DC link bus to the P(+) and N(-) terminals of the main circuit, disconnect the wires. (You do not need to disconnect a DC reactor (optional), if any.)
  - In case the standard keypad has been replaced with an optional multi-function keypad after the purchase, put back the original standard keypad.
  - Turn OFF all the digital input signals fed to terminals [FWD], [REV], and [X1] through [X5] of the control circuit.
  - If a potentiometer is connected to terminal [13], disconnect it.
  - If an external apparatus is attached to terminal [PLC], disconnect it.
  - Ensure that transistor output signals ([Y1] and [Y2]) and relay output signals ([30A/B/C]) will not be turned ON.



If negative logic is specified for the transistor output and relay output signals, they are considered ON when the inverter is not running. Specify positive logic for them.

- Keep the ambient temperature within 25°C (77°F) ±10°C (50°F).
- 2) Switch ON the main circuit power.
  - 3) Confirm that the cooling fan is rotating and the inverter is in stopped state.
  - 4) Switch OFF the main circuit power.
  - 5) Start the measurement of the capacitance of the DC link bus capacitor. Make sure that ". . . ." appears on the LED monitor.
    - If ". . . ." does not appear on the LED monitor, the measurement will not start. Check the conditions listed in 1).
  - 6) Once ". . . ." has disappeared from the LED monitor, switch ON the main circuit power again.
  - 7) Select Menu #5 "Maintenance Information" in Programming mode and note the reading (relative capacitance (%) of the DC link bus capacitor).
-



①-2 Measuring the capacitance of the DC link bus capacitor (during power-off time under ordinary operating condition)

If the measuring method for discharging condition of the DC link bus capacitor during a power-off time under the ordinary operating condition at the end user's installation is different from the initial measuring method at the time of factory shipment, the capacitance of the DC link bus capacitors can not be measured. Follow the procedure mentioned below when you measure the capacitance of the DC link bus capacitors under the ordinary operating condition at the end User's installation.

----- **Procedure for setting up measurement condition** -----

- 1) Set function code H98 (Protection/maintenance function) to enable the user to specify the judgment criteria for the service life of the DC link bus capacitor (Bit 3) (refer to function code H98).
- 2) Place the inverter in stopped state.
- 3) Place the inverter in the state of power-off under ordinary operating conditions.
- 4) Set both function codes H42 (Capacitance of DC link bus capacitor) and H47 (Initial capacitance of DC link bus capacitor) to "0000."
- 5) Switch OFF the inverter.

Measure the discharging time of the DC link bus capacitor and save the result in function code H47 (Initial capacitance of DC link bus capacitor).

The condition under which the measurement has been conducted will be automatically collected and saved.

During the measurement, ". . . ." will appear on the LED monitor.

- 6) Switch ON the inverter again. Confirm that H42 (Capacitance of DC link bus capacitor) and H47 (Initial capacitance of DC link bus capacitor) hold right values. Move to Menu #5 "Maintenance Information" and confirm that the relative capacitance (ratio to full capacitance) is 100%.

 **Note** If the measurement has failed, "0001" is entered into both H42 and H47. Check whether there has been any mistake in operation and conduct the measurement again.

-----  
To change the settings back to the state at the time of factory shipment, set H47 (Initial capacitance of DC link bus capacitor) to "0002"; the original values will be restored.

Hereafter, each time the inverter is switched OFF, the discharging time of the DC link bus capacitor is automatically measured if the above condition is met.

 **Note** The condition given above produces a rather large measurement error. If this mode gives you a lifetime alarm, set H98 (Maintenance operation) back to the default setting (Bit 3 (Specify service life criteria for replacing the DC link bus capacitor) = 0) and conduct the measurement under the condition at the time of factory shipment.

② Electrolytic capacitors on the printed circuit boards

Move to Menu #5 "Maintenance Information" in Programming mode and check the accumulated run time of the electrolytic capacitors on the printed circuit boards. This value is calculated from the cumulative total number of hours a voltage has been applied on the electrolytic capacitor. The value is displayed on the LED monitor in units of 1000 hours.

### ③ Cooling fan

Select Menu #5 "Maintenance Information" and check the accumulated run time of the cooling fan. The inverter accumulates hours for which the cooling fan has run. The display is in units of 1000 hours. The accumulated time should be used just a guide since the actual service life will be significantly affected by the temperature and operation environment.

## (2) Early warning of lifetime alarm

For the components listed in Table 7.3, you can get an early warning of lifetime alarm at one of the transistor output terminals ([Y1] and [Y2]) and the relay contact terminals ([30A/B/C]) as soon as any of the conditions listed under the "Judgment level" column has been exceeded. When the replacement data of any parts exceeds the judgment level, this signal comes ON.

Table 7.3 Criteria for Issuing a Lifetime Alarm

Parts to be replaced	Judgment level
DC link bus capacitor	85% or lower of the capacitance than that of the factory setting
Electrolytic capacitors on the printed circuit boards	87000 hours or longer as accumulated run time (estimated service life at the inverter's ambient temperature of 40°C (104°F) under 80% of full load)
Cooling fan	87000 hours or longer as accumulated run time (estimated service life at the inverter's ambient temperature of 40°C (104°F) under 80% of full load)

## 7.4 Measurement of Electrical Amounts in Main Circuit

Because the voltage and current of the power supply (input, primary circuit) of the main circuit of the inverter and those of the motor (output, secondary circuit) include harmonic components, the readings may vary with the type of the meter. Use meters indicated in Table 7.4 when measuring with meters for commercial frequencies.

The power factor cannot be measured by a commercially available power-factor meter that measures the phase difference between the voltage and current. To obtain the power factor, measure the power, voltage and current on each of the input and output sides and calculate in the following formula.





### ■ Three-phase input

$$\text{Power factor} = \frac{\text{Electric power (W)}}{\sqrt{3} \times \text{Voltage (V)} \times \text{Current (A)}} \times 100 \%$$

### ■ Single-phase input

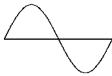
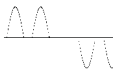
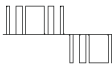
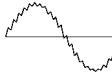
$$\text{Power factor} = \frac{\text{Electric power (W)}}{\text{Voltage (V)} \times \text{Current (A)}} \times 100 \%$$

Table 7.4 Meters for Measurement of Main Circuit

Item	Input (primary) side			Output (secondary) side			DC link bus voltage (P (+)-N (-))
Waveform	Voltage 		Current 	Voltage 		Current 	
Name of meter	Ammeter AR, AS, AT	Voltmeter VR, VS, VT	Wattmeter WR, WT	Ammeter AU, AV, AW	Voltmeter VU, VV, VW	Wattmeter WU, WW	DC voltmeter V
Type of meter	Moving iron type	Rectifier or moving iron type	Digital AC power meter	Digital AC power meter	Digital AC power meter	Digital AC power meter	Moving coil type
Symbol of meter			—	—	—	—	

**Note**

It is not recommended that meters other than a digital AC power meter be used for measuring the output voltage or output current since they may cause larger measurement errors or, in the worst case, they may be damaged.

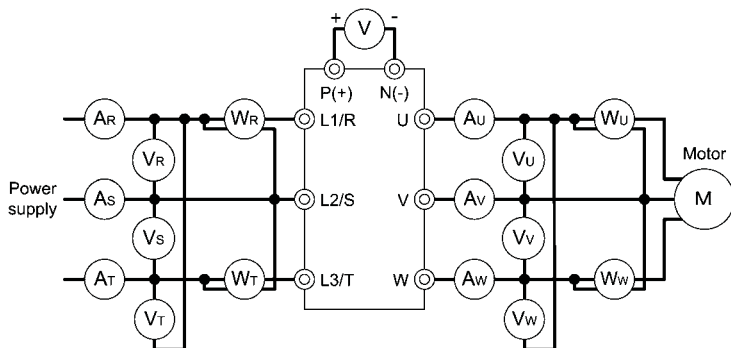

Figure 7.1 Connection of Meters

## 7.5 Insulation Test

Because an insulation test is made in the factory before shipment, avoid a Megger test.

If a Megger test is unavoidable, follow the procedure below. Because a wrong test procedure will cause breakage of the inverter, take sufficient care.

A dielectric strength test will cause breakage of the inverter similarly to the Megger test if the test procedure is wrong. When the dielectric strength test is necessary, contact your Fuji Electric representative.

### (1) Megger test of main circuit

- 1) Use a 500 VDC Megger and shut off the main power supply without fail during measurement.
- 2) If the test voltage leaks to the control circuit due to the wiring, disconnect all the control wiring.
- 3) Connect the main circuit terminals with a common cable as shown in Figure 7.2.
- 4) The Megger test must be limited to across the common line of the main circuit and the ground (⊕).
- 5) 5 M $\Omega$  (1 M $\Omega$  for the EMC filter built-in type of inverters) or a larger value displayed at the Megger indicates a correct state. (The value is for a discrete inverter.)

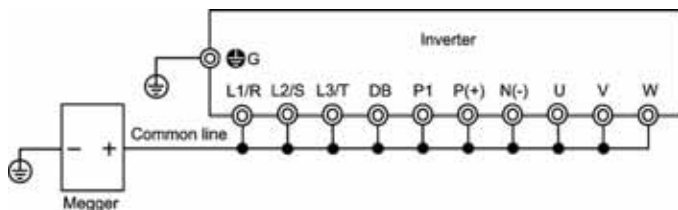

Figure 7.2 Megger Test

### (2) Dielectric strength test of control circuit

Do not perform a Megger test or dielectric strength test for the control circuit. Prepare a high resistance range tester for the control circuit.

- 1) Disconnect all the external wiring from the control circuit terminals.
- 2) Perform a continuity test to the ground. One M $\Omega$  or a larger measurement indicates a correct state.

### (3) Dielectric strength test of external main circuit and sequence control circuit

Disconnect all the inverter terminals so that the test voltage is not applied.

## 7.6 Inquiries about Product and Guarantee

### 7.6.1 When making an inquiry

Upon breakage of the product, uncertainties, failure or inquiries, inform your Fuji Electric representative of the following information.

- 1) Inverter type (Refer to Chapter 1, Section 1.1.)
- 2) SER No. (serial number of equipment) (Refer to Chapter 1, Section 1.1.)
- 3) Function codes and their data that you changed from the factory defaults (Refer to Chapter 3, Section 3.4.3.)
- 4) ROM version (Refer to Chapter 3, Section 3.4.6.)
- 5) Date of purchase
- 6) Inquiries (for example, point and extent of breakage, uncertainties, failure phenomena, and other circumstances)

### 7.6.2 Product warranty

**To all our customers who purchase Fuji Electric FA Components & Systems' products:**

Please take the following items into consideration when placing your order.

When requesting an estimate and placing your orders for the products included in these materials, please be aware that any items such as specifications which are not specifically mentioned in the contract, catalog, specifications or other materials will be as mentioned below.

In addition, the products included in these materials are limited in the use they are put to and the place where they can be used, etc., and may require periodic inspection. Please confirm these points with your sales representative or directly with this company.

Furthermore, regarding purchased products and delivered products, we request that you take adequate consideration of the necessity of rapid receiving inspections and of product management and maintenance even before receiving your products.

[ 1 ] Free of charge warranty period and warranty range

(1) Free of charge warranty period

- 1) The product warranty period is "1 year from the date of purchase" or 24 months from the manufacturing date imprinted on the name plate, whichever date is earlier.
- 2) However, in cases where the use environment, conditions of use, use frequency and times used, etc., have an effect on product life, this warranty period may not apply.
- 3) Furthermore, the warranty period for parts restored by Fuji Electric's Service Department is "6 months from the date that repairs are completed."

## (2) Warranty range

- 1) In the event that breakdown occurs during the product's warranty period which is the responsibility of Fuji Electric, Fuji Electric will replace or repair the part of the product that has broken down free of charge at the place where the product was purchased or where it was delivered. However, if the following cases are applicable, the terms of this warranty may not apply.
  - ① The breakdown was caused by inappropriate conditions, environment, handling or use methods, etc. which are not specified in the catalog, operation manual, specifications or other relevant documents.
  - ② The breakdown was caused by the product other than the purchased or delivered Fuji's product.
  - ③ The breakdown was caused by the product other than Fuji's product, such as the customer's equipment or software design, etc.
  - ④ Concerning the Fuji's programmable products, the breakdown was caused by a program other than a program supplied by this company, or the results from using such a program.
  - ⑤ The breakdown was caused by modifications or repairs affected by a party other than Fuji Electric.
  - ⑥ The breakdown was caused by improper maintenance or replacement using consumables, etc. specified in the operation manual or catalog, etc.
  - ⑦ The breakdown was caused by a chemical or technical problem that was not foreseen when making practical application of the product at the time it was purchased or delivered.
  - ⑧ The product was not used in the manner the product was originally intended to be used.
  - ⑨ The breakdown was caused by a reason which is not this company's responsibility, such as lightning or other disaster.
- (2) Furthermore, the warranty specified herein shall be limited to the purchased or delivered product alone.
- (3) The upper limit for the warranty range shall be as specified in item (1) above and any damages (damage to or loss of machinery or equipment, or lost profits from the same, etc.) consequent to or resulting from breakdown of the purchased or delivered product shall be excluded from coverage by this warranty.

## (3) Trouble diagnosis

As a rule, the customer is requested to carry out a preliminary trouble diagnosis. However, at the customer's request, this company or its service network can perform the trouble diagnosis on a chargeable basis. In this case, the customer is asked to assume the burden for charges levied in accordance with this company's fee schedule.

## [ 2 ] Exclusion of liability for loss of opportunity, etc.

Regardless of whether a breakdown occurs during or after the free of charge warranty period, this company shall not be liable for any loss of opportunity, loss of profits, or damages arising from special circumstances, secondary damages, accident compensation to another company, or damages to products other than this company's products, whether foreseen or not by this company, which this company is not be responsible for causing.

### [ 3 ] Repair period after production stop, spare parts supply period (holding period)

Concerning models (products) which have gone out of production, this company will perform repairs for a period of 7 years after production stop, counting from the month and year when the production stop occurs. In addition, we will continue to supply the spare parts required for repairs for a period of 7 years, counting from the month and year when the production stop occurs. However, if it is estimated that the life cycle of certain electronic and other parts is short and it will be difficult to procure or produce those parts, there may be cases where it is difficult to provide repairs or supply spare parts even within this 7-year period. For details, please confirm at our company's business office or our service office.

### [ 4 ] Transfer rights

In the case of standard products which do not include settings or adjustments in an application program, the products shall be transported to and transferred to the customer and this company shall not be responsible for local adjustments or trial operation.

### [ 5 ] Service contents

The cost of purchased and delivered products does not include the cost of dispatching engineers or service costs. Depending on the request, these can be discussed separately.

### [ 6 ] Applicable scope of service

Above contents shall be assumed to apply to transactions and use of the country where you purchased the products.

Consult the local supplier or Fuji for the detail separately.

## Chapter 8 SPECIFICATIONS

### 8.1 Standard Models

#### 8.1.1 Three-phase 230 V class series

Item		Specifications											
Type(FRN...E1S-2U)		F12	F25	F30	001	002	003	005	007	010	015	020	
Applicable motor rating (HP)	*1	1/8	1/4	1/2	1	2	3	5	7.5	10	15	20	
Rated capacity (kVA)	*2	0.3	0.6	1.2	2.0	3.2	4.4	6.8	10	13	18	24	
Rated voltage (V)	*3	Three-phase 200 to 240 V (with AVR function)											
Rated current (A)	*4	0.8 (0.7)	1.5 (1.4)	3.0 (2.5)	5.0 (4.2)	8.0 (7.0)	11 (10)	17 (16.5)	25 (23.5)	33 (31)	47 (44)	60 (57)	
Overload capability	*5	150% of rated current for 1 min., 200% for 0.5 s.											
Rated frequency (Hz)		50, 60 Hz											
Phases, voltage, frequency		Three-phase, 200 to 240 V, 50/60 Hz											
Voltage/frequency variations		Voltage: +10 to -15% (Voltage unbalance: 2% or less) <sup>6)</sup> , Frequency: +5 to -5%											
Rated current (A)	*7	(with DCR)	0.57	0.93	1.6	3.0	5.7	8.3	14.0	21.1	28.8	42.2	57.8
		(without DCR)	1.1	1.8	3.1	5.5	9.5	13.2	22.2	31.5	42.7	60.7	80.0
Required power supply capacity (kVA)	*8	0.2	0.3	0.6	1.1	2.0	2.9	4.9	7.4	10	15	20	
Torque (%)	*9	150		100		70		40			20		
Torque (%)	*10	150											
DC braking		Starting frequency: 0.1 to 60.0 Hz, Braking time: 0.0 to 30.0 s, Braking level: 0 to 100% of rated current											
Braking transistor		Built-in											
Applicable safety standards		UL508C, C22.2 No.14, EN50178:1997											
Enclosure (IEC60529)		IP20, UL open type											
Cooling method		Natural cooling					Fan cooling						
Weight/Mass(ks/kg)		1.3(0.8)	1.3(0.6)	1.5(0.7)	1.8(0.8)	3.7(1.7)	3.7(1.7)	5.1(2.3)	7.5(3.4)	7.9(3.6)	13.4(6.1)	15.7(7.1)	

\*1 Standard 4-pole motor

\*2 Rated capacity is calculated assuming the output rated voltage as 230 V.

\*3 Output voltage cannot exceed the power supply voltage.

\*4 Use the inverter at the current enclosed with parentheses ( ) or below when the carrier frequency is set to 4 kHz or above (F26) and the inverter continuously runs at 100% load.

\*5 In the case of inverters with a capacity of 20 HP at an ambient temperature of 45°C (104°F) or above, this overload capability is assured, provided that the inverter has run continuously with 85% of the rated current.

\*6 
$$\text{Voltage unbalance (\%)} = \frac{\text{Max voltage (V)} - \text{Min voltage (V)}}{\text{Three - phase average voltage (V)}} \times 67 \text{ (IEC 61800 - 3)}$$

If this value is 2 to 3%, use an optional AC reactor (ACR).

\*7 The value is calculated assuming that the inverter is connected with a power supply with the capacity of 500 kVA (or 10 times the inverter capacity if the inverter capacity exceeds 50 kVA) and %X is 5%.

\*8 Obtained when a DC reactor (DCR) is used.

\*9 Average braking torque obtained when reducing the speed from 60 Hz with AVR control OFF. (It varies with the efficiency of the motor.)

\*10 Average braking torque obtained by use of an external braking resistor (standard type available as option)



## 8.1.2 Three-phase 460 V class series

Item		Specifications									
Type(FRN...E1S4L)		F50	001	002	003	005	007	010	015	020	
Applicable motor rating (HP)		*1	1/2	1	2	3	5	7.5	10	15	20
Rated capacity (kVA)		*2	1.2	2.0	2.9	4.4	7.2	10	14	18	24
Output ratings	Rated voltage (V)	*3	Three-phase 380 to 480 V (with AVR function)								
	Rated current (A)	*4	1.5	2.5	3.7	5.5	9.0	13	18	24	30
	Overload capability	*5	150% of rated current for 1 min., 200% for 0.5 s.								
	Rated frequency (Hz)		50, 60 Hz								
	Phases, voltage, frequency		Three-phase, 380 to 480 V, 50/60 Hz								
Input power	Voltage/frequency variations		Voltage: +10 to -15% (Voltage unbalance: 2% or less) <sup>6</sup> ; Frequency: +5 to -5%								
	Rated current (A)	(with DCR)	0.85	1.6	3.0	4.4	7.3	10.6	14.4	21.1	28.8
		(without DCR)	1.7	3.1	5.9	8.2	13.0	17.3	23.2	33.0	43.8
	Required power supply capacity (kVA)	*8	0.6	1.1	2.0	2.9	4.9	7.4	10	15	20
	Torque (%)	*9	100		70		40		20		
Braking	Torque (%)	*10	150								
	DC braking		Starting frequency: 0.1 to 60.0 Hz, Braking time: 0.0 to 30.0 s, Braking level: 0 to 100% of rated current								
	Braking resistor		Built-in								
	Applicable safety standards		UL508C, C22.2 No.14, EN50178:1997								
	Enclosure (IEC60529)		IP20, UL open type								
Cooling method		Natural cooling				Fan cooling					
Weight/Mass(2e/kg)		2.4(1.1)	2.6(1.2)	3.7(1.7)	3.7(1.7)	5.1(2.3)	7.5(3.4)	7.9(3.6)	13.4(6.1)	15.7(7.1)	

\*1 Standard 4-pole motor

\*2 Rated capacity is calculated assuming the output rated voltage as 460 V.

\*3 Output voltage cannot exceed the power supply voltage.

\*4 Use the inverter at the current enclosed with parentheses ( ) or below when the carrier frequency is set to 4 kHz or above (F26) and the inverter continuously runs at 100% load.

\*5 In the case of inverters with a capacity of 20 HP at an ambient temperature of 45°C (104°F) or above, this overload capability is assured, provided that the inverter has run continuously with 85% of the rated current.

\*6 
$$\text{Voltage unbalance (\%)} = \frac{\text{Max voltage (V)} - \text{Min voltage (V)}}{\text{Three - phase average voltage (V)}} \times 67 \text{ (IEC 61800 - 3)}$$

If this value is 2 to 3%, use an optional AC reactor (ACR).

\*7 The value is calculated assuming that the inverter is connected with a power supply with the capacity of 500 kVA (or 10 times the inverter capacity if the inverter capacity exceeds 50 kVA) and %X is 5%.

\*8 Obtained when a DC reactor (DCR) is used.

\*9 Average braking torque obtained when reducing the speed from 60 Hz with AVR control OFF. (It varies with the efficiency of the motor.)

\*10 Average braking torque obtained by use of an external braking resistor (standard type available as option)

### 8.1.3 Single-phase 230 V class series

Item		Specifications							
Type(FRN... E1S-7U)		F12	F25	F50	001	002	003		
Applicable motor rating (HP)		*1	1/8	1/4	1/2	1	2	3	
Rated capacity (kVA)		*2	0.3	0.6	1.2	2.0	3.2	4.4	
Output ratings	Rated voltage (V)	*3	Three-phase 200 to 240 V (with AVR function)						
	Rated current (A)	*4	0.8 (0.7)	1.5 (1.4)	3.0 (2.5)	5.0 (4.2)	9.0 (7.0)	11 (10)	
	Overload capability		150% of rated current for 1 min., 200% for 0.5 s.						
Rated frequency (Hz)			50, 60 Hz						
Phases, voltage, frequency			Single-phase, 200 to 240 V, 50/60 Hz						
Voltage/frequency variations			Voltage: +10 to -10%, Frequency: +5 to -5%						
Input power	Rated current (A)	*5	(with DCR)	1.1	2.0	3.5	6.4	11.6	17.5
			(without DCR)	1.8	3.3	5.4	9.7	16.4	24.0
	Required power supply capacity (kVA)	*6	0.3	0.4	0.7	1.3	2.4	3.5	
Braking	Torque (%)	*7	100		100		70	40	
	Torque (%)	*8	150						
	DC braking		Starting frequency: 0.1 to 60.0 Hz, Braking level: 0 to 100% of rated current, Braking time: 0.0 to 30.0 s						
	Braking transistor		Built in						
Applicable safety standards			UL508C, C22.2 No. 14, EN50178:1997						
Enclosure (IEC60529)			IP20, UL open type						
Cooling method			Natural cooling				Fan cooling		
Weights/Mass(lbs/kg)			1.3(0.6)	1.3(0.6)	1.5(0.7)	2.0(0.9)	4.0(1.8)	5.3(2.4)	

\*1 Standard 4-pole motor

\*2 Rated capacity is calculated by assuming the output rated voltage as 230 V.

\*3 Output voltage cannot exceed the power supply voltage.

\*4 Use the inverter at the current enclosed with parentheses ( ) or below when the carrier frequency is set to 4 kHz or above (F26) and the inverter continuously runs at 100% load.

\*5 The value is calculated assuming that the inverter is connected with a power supply with the capacity of 500 kVA (or 10 times the inverter capacity if the inverter capacity exceeds 50 kVA) and %X is 5%.

\*6 Obtained when a DC reactor (DCR) is used.

\*7 Average braking torque obtained when reducing the speed from 60 Hz with AVR control OFF. (It varies with the efficiency of the motor.)

\*8 Average braking torque obtained by use of an external braking resistor (standard type available as option)

## 8.2 Models Available on Order (EMC filter built-in type)

### 8.2.1 Three-phase 230 V class series

Item		Specifications										
Type(FRN___E1E-2U)		F12	F25	F50	001	002	003	005	007	010	015	020
Applicable motor rating (HP) *1		1/8	1/4	1/2	1	2	3	5	7.5	10	15	20
Weight(lbs(kg))		1.5 (0.7)	1.5 (0.7)	1.8 (0.8)	2.0 (0.9)	5.3 (2.4)	5.3 (2.4)	6.4 (2.9)	11.2 (5.1)	11.7 (5.3)	22.7 (10.3)	24.9 (11.3)
EMC Directives (EN61800-3:2004)	Emission	Category C2						Category C3				
	Immunity	Category C3						Category C3				

\*1 Standard 4-pole motors

Other than those items in the above table are the same as those in Section 8.1 " Standard Models."

### 8.2.2 Three-phase 460 V class series

Item		Specifications										
Type(FRN___E1E-4U)		F50	001	002	003	005	007	010	015	020		
Applicable motor rating (HP) *1		1/2	1	2	3	5	7.5	10	15	20		
Weight(lbs(kg))		3.3 (1.5)	3.5 (1.6)	5.5 (2.5)	5.5 (2.5)	6.6 (3.0)	10.6 (4.8)	11.0 (5.0)	17.9 (8.1)	20.0 (9.1)		
EMC Directives (EN61800-3:2004)	Emission	Category C2						Category C3				
	Immunity	Category C3						Category C3				

\*1 Standard 4-pole motors

Other than those items in the above table are the same as those in Section 8.1 " Standard Models."

### 8.2.3 Single-phase 230 V class series

Item		Specifications					
Type(FRN___E1E-7U)		F12	F25	F50	001	002	003
Applicable motor rating (HP) *1		1/8	1/4	1/2	1	2	3
Weight(lbs(kg))		1.5 (0.7)	1.5 (0.7)	1.8 (0.8)	2.9 (1.3)	5.5 (2.5)	6.6 (3.0)
EMC Directives (EN61800-3:2004)	Emission	Category C2					
	Immunity	Category C3					

\*1 Standard 4-pole motors

## 8.3 Specifications of Keypad Related

### 8.3.1 General specifications of keypad

Table 8.1 General Specifications

Items	Specification	Remarks
Protective structure	Front side: IP40, Back (mounting) side: IP20	
Site to be installed	In door	
Ambient temperature	-10°C (14°F) to 50°C (122°F)	
Ambient humidity	5 to 95% RH, no condensation allowed	
Ambient air	No corrosive gas, no inflammable gas, no dust, and no direct sunlight allowed	
Altitude	3281ft (1000 m) or less	(Note)
Air pressure	86 to 106 kPa	
Vibration	3 mm (maximum amplitude): Within 2 to 9 Hz 9.8 m/s <sup>2</sup> : Within 9 to 20 Hz 2 m/s <sup>2</sup> : Within 20 to 55 Hz 1 m/s <sup>2</sup> : Within 55 to 200 Hz	
Storage ambient temperature	-25 (-13°F) to 70°C(158°F)	
Storage ambient humidity	5 to 95% RH (no condensation allowed)	
External dimension	Refer to Section 8.4.2 "Standard keypad"	
Mass	0.081 lbs(35 grams)	With a keypad rear cover

(Note) When using an inverter in a place of an altitude within 3281ft (1000 m) to 9843ft (3000 m), you need to lower the output current of the inverter. For details, refer to Chapter 2, Section 2.1 "Operating Environment."

### 8.3.2 Communications specifications of keypad

Table 8.2 Hardware specifications

Items	Specification	Remarks
No. of linkable unit	One-to-one connection with an inverter	For a remote site operation.
Link cable	US ANSI TIA/EIA-568A category 5 compliant straight type cable (10BASE-T/100BASE-TX straight type)	Extension cable for the remote site operation (CB-5S, CB-3S, CB-1S and etc.)
Maximum cable length	66ft (20 m)	
Connector	Standard RJ-45 connector/jack	Refer to Table 8.3

Table 8.3 Pin Assignment of RJ-45 Connector

Pin number	Signal	Description	Remarks
1 and 8	Vcc	Power supply lines for keypad	5 VDC
2 and 7	GND	Reference potential	0 V
3 and 6	NC	Reserved	
4	DX-	RS-485 communications data line (-)	
5	DX+	RS-485 communications data line (+)	

## 8.4 Terminal Specifications

### 8.4.1 Terminal functions

For details about the main and control circuit terminals, refer to Chapter 2, Section 2.3.5 and Section 2.3.6 (Table 2.9), respectively.

### 8.4.2 Running the inverter with keypad

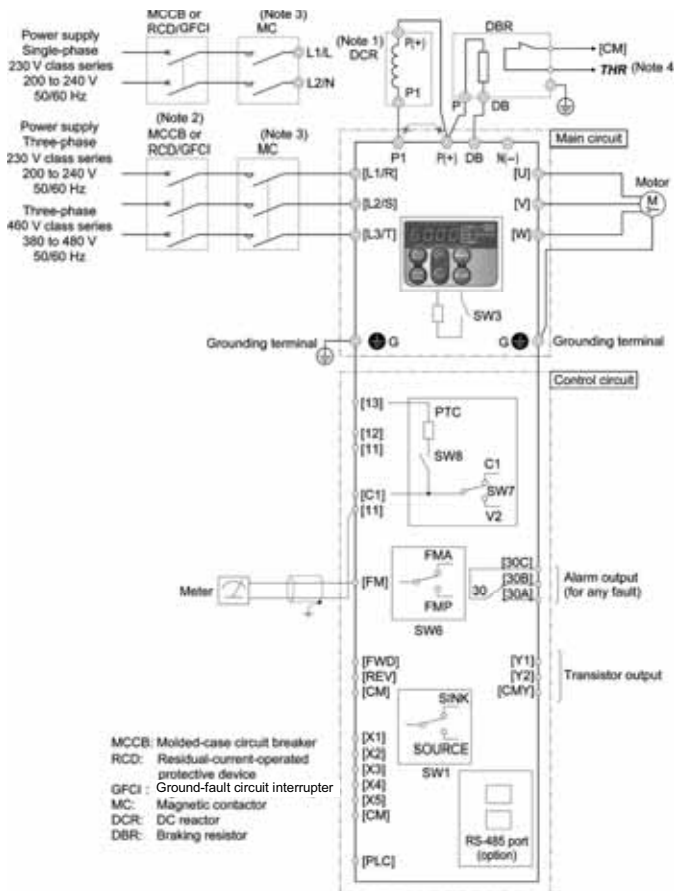

(Note 1) When connecting an optional DCR, remove the jumper bar from the terminals [P1] and [P +].

(Note 2) Install a recommended MCCB or RCD/GFCI (with overcurrent protection) in the primary circuit of the inverter to protect wiring. At this time, ensure that the circuit breaker capacity is equivalent to or lower than the recommended capacity.

(Note 3) Install an MC for each inverter to separate the inverter from the power supply, apart from the MCCB or RCD/GFCI, when necessary.  
Connect a surge killer in parallel when installing a coil such as the MC or solenoid near the inverter.

(Note 4) **THR** function can be used by assigning code "9" (external alarm) to any of the terminals [X1] to [X5], [FWD] and [REV] (function code; E01 to E05, E98, or E99).

## 8.4.3 Running the inverter by terminal commands

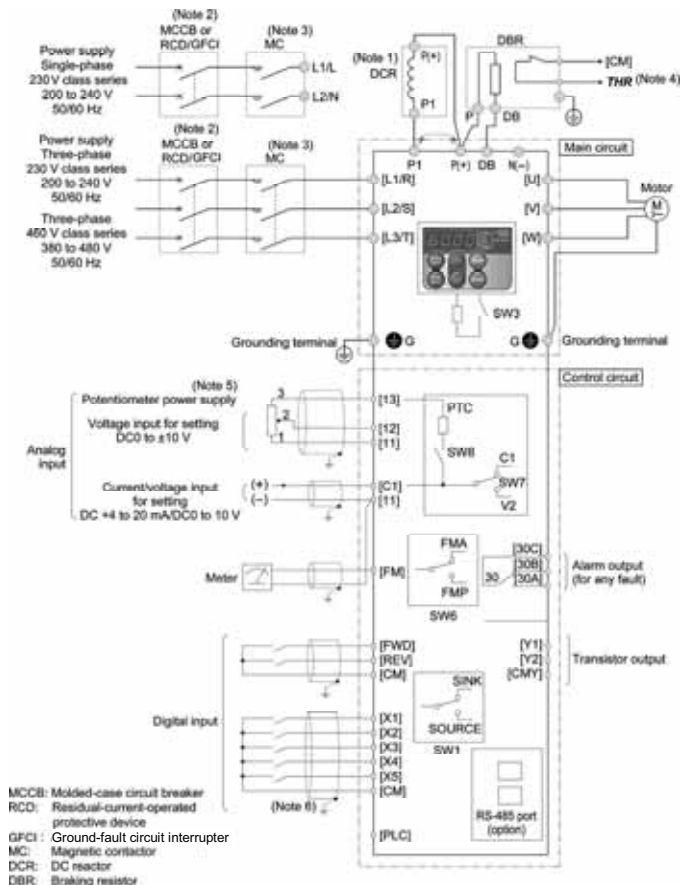

- (Note 1) When connecting an optional DCR, remove the jumper bar from the terminals [P1] and [P (+)].
- (Note 2) Install a recommended MCCB or RCD/GFCI (with overcurrent protection) in the primary circuit of the inverter to protect wiring. At this time, ensure that the circuit breaker capacity is equivalent to or lower than the recommended capacity.
- (Note 3) Install an MC for each inverter to separate the inverter from the power supply, apart from the MCCB or RCD/GFCI, when necessary. Connect a surge killer in parallel when installing a coil such as the MC or solenoid near the inverter.
- (Note 4) **THR** function can be used by assigning code "9" (external alarm) to any of the terminals [X1] to [X5], [FWD] and [REV] (function code: E01 to E05, E98, or E99).
- (Note 5) Frequency can be set by connecting a frequency-setting device (external potentiometer) between the terminals [11], [12] and [13] instead of inputting a voltage signal (0 to +10 VDC, 0 to +5 VDC or +1 to +5 VDC) between the terminals [12] and [11].
- (Note 6) For the control signal wires, use shielded or twisted pair wires. Ground the shielded wires. To prevent malfunction due to noise, keep the control circuit wiring away from the main circuit wiring as far as possible (recommended: 10 cm or more). Never install them in the same wire duct. When crossing the control circuit wiring with the main circuit wiring, set them at right angles.

## 8.5 External Dimensions

### 8.5.1 Standard models

Unit: inch(mm)

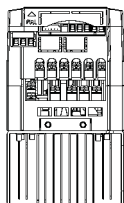
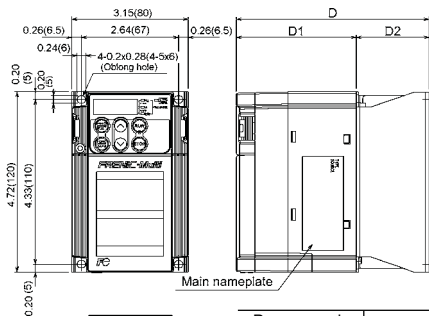

Power supply voltage	Inverter type	Dimensions [inch(mm)]		
		D	D1	D2
Three-phase 230 V	FRNF12E1S-2U	3.62(92)	3.23(82)	0.39(10)
	FRNF25E1S-2U			0.98(25)
	FRNF50E1S-2U	4.21(107)		1.97(50)
Single-phase 230 V	FRN001E1S-2U	5.20(132)	4.02(102)	0.39(10)
	FRNF12E1S-7U	3.62(92)		0.98(25)
	FRNF25E1S-7U	4.21(107)		1.97(50)
	FRNF50E1S-7U	5.00(152)		

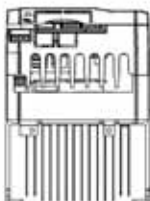
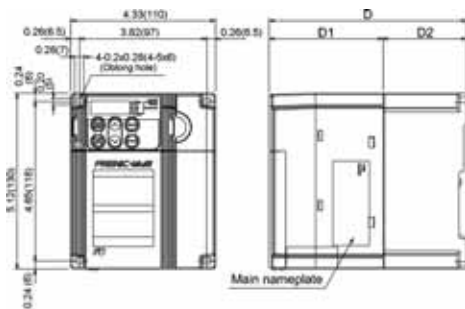

Power supply voltage	Inverter type	Dimensions [inch(mm)]		
		D	D1	D2
Three-phase 460 V	FRNF50E1S-4U	4.96(126)	3.39(86)	1.57(40)
	FRN001E1S-4U	5.90(150)		2.52(64)

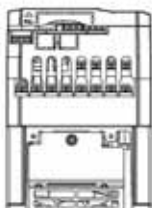
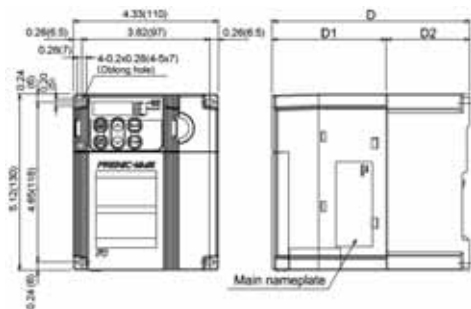

Power supply voltage	Inverter type	Dimensions [inch(mm)]		
		D	D1	D2
Three-phase 230 V	FRN002E1S-2U	5.90 (150)	3.39 (86)	2.52 (64)
	FRN003E1S-2U			
Three-phase 460 V	FRN002E1S-4U	6.30 (160)	3.78 (96)	
	FRN003E1S-4U			
Single-phase 230 V	FRN002E1S-7U			

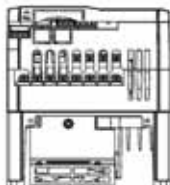
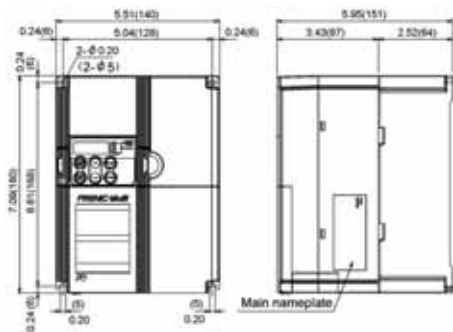

Power supply voltage	Inverter type
Three-phase 230 V	FRN005E1S-2U
Three-phase 460 V	FRN005E1S-4U
Single-phase 230 V	FRN003E1S-7U



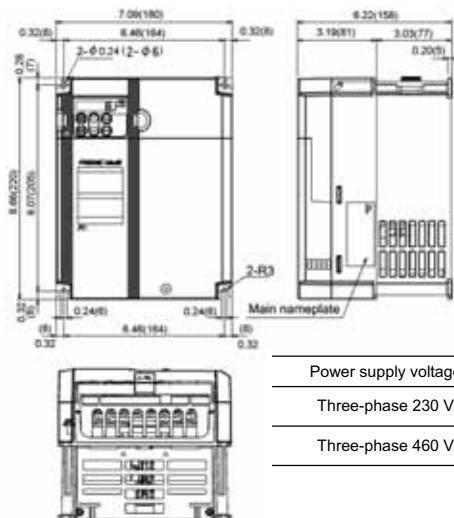

Power supply voltage	Inverter type
Three-phase 230 V	FRN007E1S-2U
	FRN010E1S-2U
Three-phase 460 V	FRN007E1S-4U
	FRN010E1S-4U

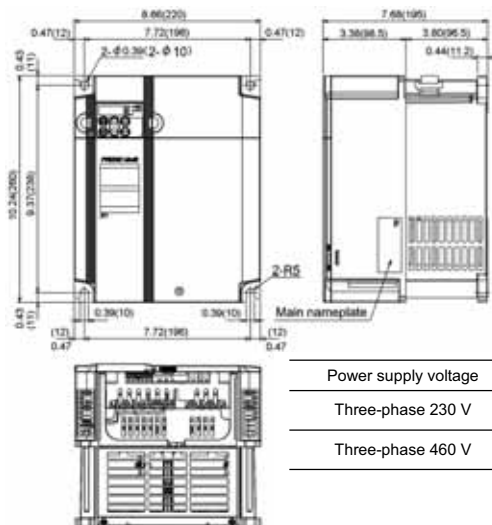

Power supply voltage	Inverter type
Three-phase 230 V	FRN015E1S-2U
	FRN020E1S-2U
Three-phase 460 V	FRN015E1S-4U
	FRN020E1S-4U

## 8.5.2 Models Available on Order (EMC filter built-in type)

Unit: inch(mm)

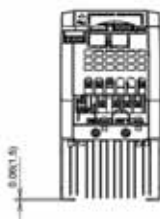
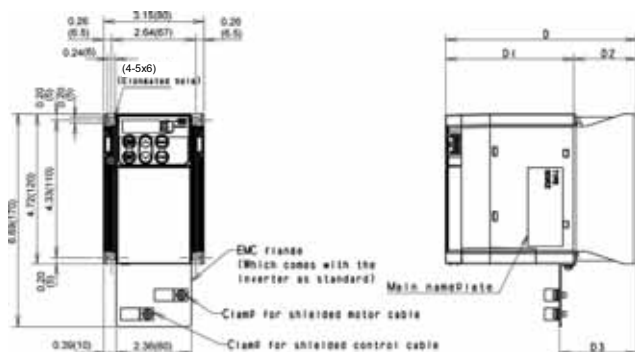

Power supply voltage	Inverter type	Dimensions(inch/mm)			
		D	D1	D2	D3
Three-phase 230V	FRNF12E1E-2U	4.41 (112)	4.02 (102)	0.39 (10)	0.83 (21.2)
	FRNF25E1E-2U	5.99 (152)		0.98 (25)	1.43 (36.3)
	FRNF50E1E-2U	7.57 (193)		1.37 (35)	2.43 (61.3)
	FRN001E1E-2U	8.83 (225)		1.87 (47.5)	3.43 (87.3)
Single-phase 230V	FRNF12E1E-7U	4.41 (112)	4.02 (102)	0.39 (10)	0.83 (21.2)
	FRNF25E1E-7U	5.99 (152)	4.02 (102)	0.39 (10)	0.83 (21.2)
	FRNF50E1E-7U	7.57 (193)	4.02 (102)	0.39 (10)	0.83 (21.2)

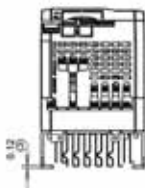
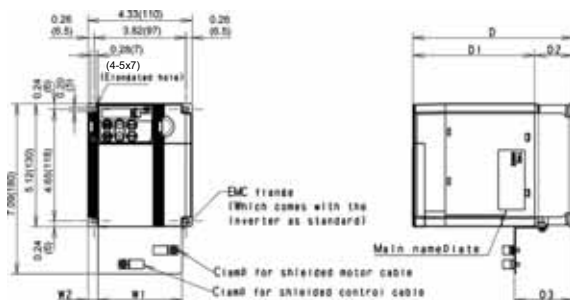

Power supply voltage	Inverter type	Dimensions(inch/mm)					
		W1	W2	D	D1	D2	D3
Three-phase 460V	FRNF50E1E-4U	3.50 (89)	0.41 (10.5)	6.65 (169)	5.08 (129)	1.58 (40)	2.42 (61.5)
	FRN001E1E-4U	7.60 (193)	0.51 (13)	7.60 (193)	5.08 (129)	2.52 (64)	3.37 (85.5)
Single-phase 230V	FRN001E1E-7U	2.36 (60)	0.51 (13)	5.90 (150)	4.33 (110)	1.58 (40)	2.17 (55.2)

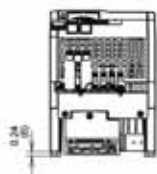
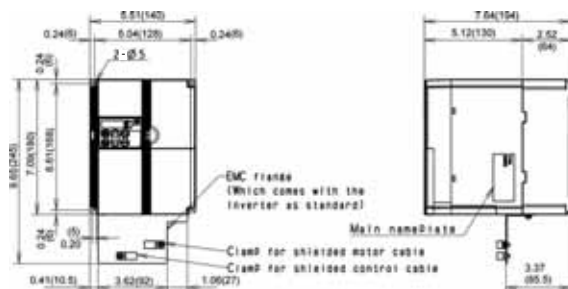

Power supply voltage	Inverter type
Three-phase 230V	FRN002E1E-2U
	FRN003E1E-2U
	FRN005E1E-2U
Three-phase 460V	FRN002E1E-4U
	FRN003E1E-4U
	FRN005E1E-4U
Single-phase 230V	FRN002E1E-7U
	FRN003E1E-7U

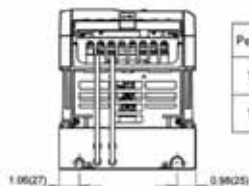
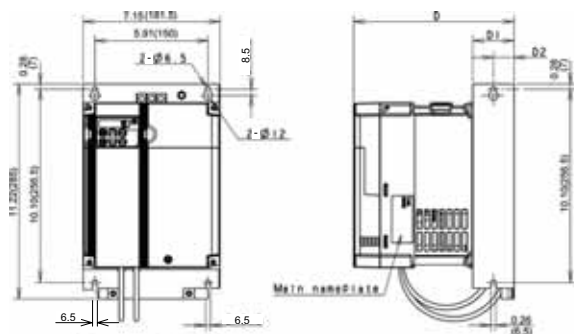

Power supply voltage	Inverter type	Dimensions (inch/mm)		
		Ø	Ø1	Ø2
Three-phase 230V	FRN007E1E-2U	8.39	2.17	1.08
	FRN010E1E-2U	(213)	(55)	(27.5)
Three-phase 460V	FRN007E1E-4U	8.19	1.97	0.98
	FRN010E1E-4U	(208)	(50)	(25)

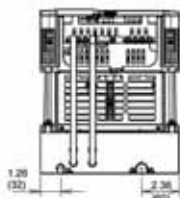
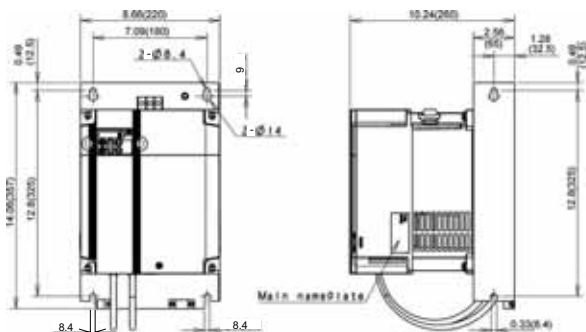

Power supply voltage	Inverter type
Three-Phase 230V	FRN015E1E-2U
	FRN020E1E-2U

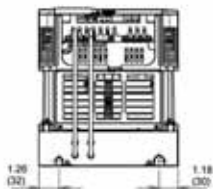
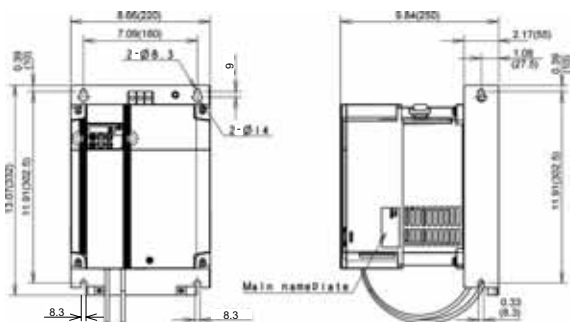

Power supply voltage	Inverter type
Three-Phase 460V	FRN015E1E-4U
	FRN020E1E-4U

### 8.5.3 Standard keypad

Unit: inch(mm)

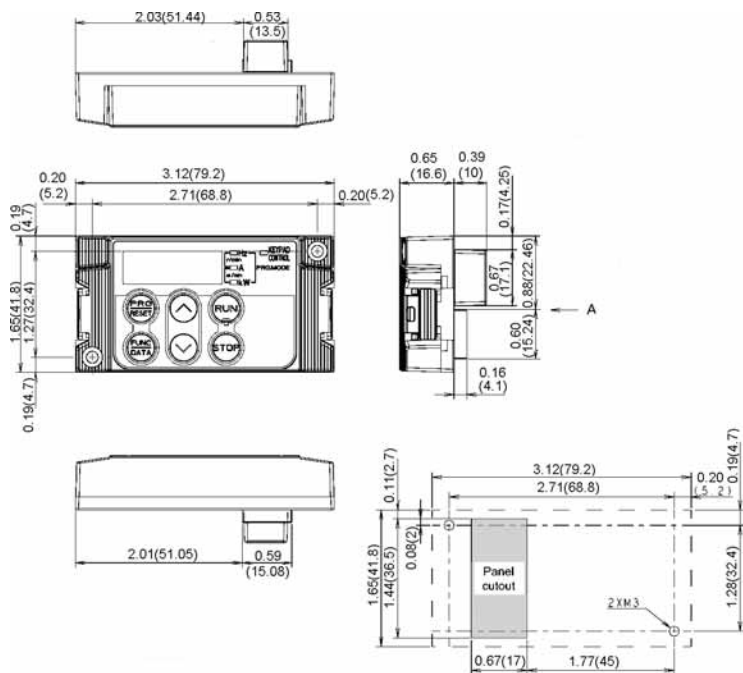

For remote operation or panel wall-mounting

(The keypad rear cover should be mounted.)

Dimensions of holes in panel (viewed from A)



## 8.6 Protective Functions

Name	Description	LED monitor displays	Alarm output [30A/B/C]	
Overcurrent protection	Stops the inverter output to protect the inverter from an overcurrent resulting from overload.	During acceleration	<i>OC1</i>	Yes
Short-circuit protection	Stops the inverter output to protect the inverter from overcurrent due to a short-circuiting in the output circuit.	During deceleration	<i>OC2</i>	
Ground fault protection	Stops the inverter output to protect the inverter from overcurrent due to a ground fault in the output circuit. This protection is effective only during startup of the inverter. If you turn ON the inverter without removing the ground fault, this protection may not work.	During running at constant speed	<i>OC3</i>	
Overvoltage protection	Stops the inverter output upon detection of an overvoltage condition (400 VDC for three-phase 230 V, 800 VDC for three-phase 460 V class series) in the DC link bus.  This protection is not assured if extremely large AC line voltage is applied inadvertently.	During acceleration	<i>OV1</i>	Yes
		During deceleration	<i>OV2</i>	
		During running at constant speed (stopped)	<i>OV3</i>	
Undervoltage protection	Stops the inverter output when the DC link bus voltage drops below the undervoltage level (200 VDC for three-phase 230 V, 400 VDC for three-phase 460 V class series).  However, if data "4 or 5" is selected for F14, no alarm is output even if the DC link bus voltage drops.		<i>UV</i>	Yes*1
Input phase loss protection	Detects input phase loss, stopping the inverter output. This function prevents the inverter from undergoing heavy stress that may be caused by input phase loss or inter-phase voltage unbalance and may damage the inverter.  If connected load is light or a DC reactor is connected to the inverter, this function will not detect input phase loss if any.		<i>L in</i>	Yes
Output phase loss protection	Detects breaks in inverter output wiring at the start of running and during running, stopping the inverter output.		<i>OPL</i>	Yes
Overheat protection	Stops the inverter output upon detecting excess heat sink temperature in case of cooling fan failure or overload.		<i>OH1</i>	Yes
	Discharging and inverter operation are stopped due to overheating of an external braking resistor.  * Function codes must be set corresponding to the braking resistor.		<i>OBH</i>	Yes

\*1 This alarm on [30A/B/C] should be ignored depending upon the function code setting.

Name	Description	LED monitor displays	Alarm output [30A/B/C]
Overload protection	Stops the inverter output if the Insulated Gate Bipolar Transistor (IGBT) internal temperature calculated from the output current and temperature of inside the inverter is over the preset value.	<i>OL1</i>	Yes
External alarm input	Places the inverter in alarm-stop state upon receiving digital input signal <b>THR</b> .	<i>OL2</i>	Yes
Motor protection	Electronic thermal overload  In the following cases, the inverter stops running the motor to protect the motor in accordance with the electronic thermal overload protection setting. - Protects general-purpose motors over the entire frequency range (F10 = 1.) - Protects inverter motors over the entire frequency range (F10 = 2.) The operation level and thermal time constant can be set by F11 and F12. For motor 2, read F10 to F12 as A06 to A08.	<i>OL1</i> <i>OL2</i>	Yes
	PTC thermistor  A PTC thermistor input stops the inverter output for motor protection.  Connect a PTC thermistor between terminals [C1] and [11] and set the function codes and slide switch on the interface PCB accordingly.	<i>OL4</i>	Yes
	Overload early warning	Outputs a preliminary alarm at a preset level before the inverter is stopped by the electronic thermal overload protection for the motor.	—
Stall prevention	Operates when instantaneous overcurrent limiting is active.	—	—
	Instantaneous overcurrent limiting: Operates if the inverter's output current exceeds the instantaneous overcurrent limit level, avoiding tripping of the inverter (during constant speed operation or during acceleration).		
Alarm relay output (for any fault)	The inverter outputs a relay contact signal when the inverter issues an alarm and stops the inverter output. < Alarm reset > The alarm stop state is reset by pressing the  key or by the digital input signal <b>RST</b> . < Saving the alarm history and detailed data > The information on the previous 4 alarms can be saved and displayed.	—	Yes
Memory error detection	The inverter checks memory data after power-on and when the data is written. If a memory error is detected, the inverter stops.	<i>Er1</i>	Yes
Keypad communications error detection	The inverter stops by detecting a communications error between the inverter and the keypad during operation using the standard keypad or the multi-function keypad (optional).	<i>Er2</i>	Yes
CPU error detection	If the inverter detects a CPU error or LSI error caused by noise or some other factors, this function stops the inverter.	<i>Er3</i>	Yes

"—": Not applicable.

Name	Description		LED monitor displays	Alarm output [30A/B/C]
Option communications error detection	Upon detection of an error in the communication between the inverter and an optional card, stops the inverter output.		<i>E-4</i>	Yes
Option error detection	When an option card has detected an error, this function stops the inverter output.		<i>E-5</i>	Yes
Operation protection	STOP key priority	Pressing the  key on the keypad forces the inverter to decelerate and stop the motor even if the inverter is running by any run commands given via the terminals or communications (link operation). After the motor stops, the inverter issues alarm <i>E-5</i> .	<i>E-5</i>	Yes
	Start check function	The inverter prohibits any run operations and displays <i>E-5</i> on the 7-segment LED monitor if any run command is present when: <ul style="list-style-type: none"> <li>- Powering up</li> <li>- An alarm is released (the  key is turned ON or an alarm reset <b>RST</b> is input.)</li> <li>- "Enable communications link <b>LE</b>" has been activated and the run command is active in the linked source.</li> </ul>	<i>E-5</i>	Yes
Tuning error detection	During tuning of motor parameters, if the tuning has failed or has aborted, or an abnormal condition has been detected in the tuning result, the inverter stops its output.		<i>E-7</i>	Yes
RS-485 communications error detection	When the inverter is connected to a communications network via the RS-485 port designed for the keypad, detecting a communications error stops the inverter output and displays an error code <i>E-8</i> .		<i>E-8</i>	Yes
Data save error during under-voltage	If the data could not be saved during activation of the undervoltage protection function, the inverter displays the alarm code.		<i>E-F</i>	Yes
RS-485 communications error detection (optional)	When the inverter is connected to a communications network via an optional RS-485 communications card, detecting a communications error stops the inverter output and displays an error code <i>E-P</i> .		<i>E-P</i>	Yes
Retry	When the inverter has stopped because of a trip, this function allows the inverter to automatically reset itself and restart. (You can specify the number of retries and the latency between stop and reset.)		—	—
Surge protection	Protects the inverter against surge voltages which might appear between one of the power lines for the main circuit and the ground.		—	—
Command loss detected	Upon detecting a loss of a frequency command (because of a broken wire, etc.), this function issues an alarm and continues the inverter operation at the preset reference frequency (specified as a ratio to the frequency just before the detection).		—	—

"—": Not applicable.



Name	Description	LED monitor displays	Alarm output [30A/B/C]
Protection against momentary power failure	<p>Upon detecting a momentary power failure lasting more than 15 ms, this function stops the inverter output.</p> <p>If restart after momentary power failure is selected, this function invokes a restart process when power has been restored within a predetermined period.</p>	—	—
Overload prevention control	In the event of overheating of the heat sink or an overload condition (alarm code: $\overline{OH}$ / or $\overline{OL}$ ), the output frequency of the inverter is reduced to keep the inverter from tripping.	—	—
Hardware error	The inverter is stopped when poor connection between the control printed circuit board (control PCB) and power printed circuit board (power PCB), interface printed circuit board (interface PCB) or option card, or short-circuit between terminals [13] and [11] is detected.	$\overline{EH}$	Yes
Mock alarm	Simulated alarm is output to check the fault sequence.	$\overline{ERR}$	Yes
PID feedback wire break detection	When the inverter is under PID control, detecting a PID feedback wire break stops the inverter output and displays an error code $\overline{LOF}$ .	$\overline{LOF}$	Yes

—: Not applicable.

## Chapter 9 LIST OF PERIPHERAL EQUIPMENT AND OPTIONS

The table below lists the main peripheral equipment and options that are connected to the FRENIC-Multi. Use them in accordance with your system requirements.

 For details, refer to the FRENIC-Multi User's Manual, Chapter 6 "SELECTING PERIPHERAL EQUIPMENT."

	Name of peripheral equipment	Function and application																																																																																													
Main peripheral equipment	<p>Molded case circuit breaker (MCCB)</p> <p>Residual-current-operated protective device (RCD)</p> <p>/Ground fault circuit interrupter (GFCI)*1</p> <p>*1 with overcurrent protection</p>	<p>MCCBs are designed to protect the power circuits between the power control board and inverter's main terminals (L1/R, L2/S and L3/T for three-phase input power supply, L1/L and L2/N for single-phase input power supply) from overload or short-circuit which in turn prevents secondary disasters caused by the inverter malfunctioning.</p> <p>RCDs/GFCIs function in the same way as MCCBs. Use the MCCBs and RCDs/GFCIs that satisfy the recommended rated current listed below.</p> <table border="1" data-bbox="352 422 953 1033"> <thead> <tr> <th rowspan="2">Input power supply</th> <th rowspan="2">Nominal applied motor (HP)</th> <th rowspan="2">Inverter type</th> <th colspan="2">Rated current of MCCB and GFCI (A)</th> </tr> <tr> <th>w/ DCR</th> <th>w/o DCR</th> </tr> </thead> <tbody> <tr> <td rowspan="10">Three-phase 230 V</td> <td>1/8</td> <td>FRNF12E1-2U</td> <td rowspan="4">5</td> <td rowspan="4">5</td> </tr> <tr> <td>1/4</td> <td>FRNF25E1-2U</td> </tr> <tr> <td>1/2</td> <td>FRNF50E1-2U</td> </tr> <tr> <td>1</td> <td>FRN001E1-2U</td> </tr> <tr> <td>2</td> <td>FRN002E1-2U</td> <td rowspan="6">10</td> <td>10</td> </tr> <tr> <td>3</td> <td>FRN003E1-2U</td> <td>15</td> </tr> <tr> <td>5</td> <td>FRN005E1-2U</td> <td>20</td> </tr> <tr> <td>7.5</td> <td>FRN007E1-2U</td> <td>30</td> </tr> <tr> <td>10</td> <td>FRN010E1-2U</td> <td>40</td> </tr> <tr> <td>15</td> <td>FRN015E1-2U</td> <td>50</td> </tr> <tr> <td>20</td> <td>FRN020E1-2U</td> <td>75</td> <td>125</td> </tr> <tr> <td rowspan="8">Three-phase 460 V</td> <td>1/2</td> <td>FRNF50E1-4U</td> <td rowspan="4">5</td> <td rowspan="4">5</td> </tr> <tr> <td>1</td> <td>FRN001E1-4U</td> </tr> <tr> <td>2</td> <td>FRN002E1-4U</td> </tr> <tr> <td>3</td> <td>FRN003E1-4U</td> </tr> <tr> <td>5</td> <td>FRN005E1-4U</td> <td>10</td> <td>20</td> </tr> <tr> <td>7.5</td> <td>FRN007E1-4U</td> <td>15</td> <td>30</td> </tr> <tr> <td>10</td> <td>FRN010E1-4U</td> <td>20</td> <td>40</td> </tr> <tr> <td>15</td> <td>FRN015E1-4U</td> <td>30</td> <td>50</td> </tr> <tr> <td>20</td> <td>FRN020E1-4U</td> <td>40</td> <td>60</td> </tr> <tr> <td rowspan="5">Single-phase 230 V</td> <td>1/8</td> <td>FRNF12E1-7U</td> <td rowspan="3">5</td> <td rowspan="3">5</td> </tr> <tr> <td>1/4</td> <td>FRNF25E1-7U</td> </tr> <tr> <td>1/2</td> <td>FRNF50E1-7U</td> </tr> <tr> <td>1</td> <td>FRN001E1-7U</td> <td>10</td> <td>15</td> </tr> <tr> <td>2</td> <td>FRN002E1-7U</td> <td>15</td> <td>20</td> </tr> <tr> <td>3</td> <td>FRN003E1-7U</td> <td>20</td> <td>30</td> </tr> </tbody> </table> <p><b>Note 1)</b> A box (■) in the above table replaces S or E depending on the enclosure.</p> <p>Select the MCCB or RCD/GFCI with appropriate breaking capacity according to the power supply capacity.</p> <div style="border: 1px solid black; padding: 10px; margin-top: 10px;"> <p style="text-align: center;"><b>⚠ WARNING</b></p> <p>When connecting the inverter to the power supply, add a recommended molded case circuit breaker (MCCB) or residual-current-operated protective device (RCD)/a ground fault circuit interrupter (GFCI) (with overcurrent protection) in the path of power supply. Do not use the devices with the rated current out of the recommended range.</p> <p><b>Fire could occur.</b></p> </div>	Input power supply	Nominal applied motor (HP)	Inverter type	Rated current of MCCB and GFCI (A)		w/ DCR	w/o DCR	Three-phase 230 V	1/8	FRNF12E1-2U	5	5	1/4	FRNF25E1-2U	1/2	FRNF50E1-2U	1	FRN001E1-2U	2	FRN002E1-2U	10	10	3	FRN003E1-2U	15	5	FRN005E1-2U	20	7.5	FRN007E1-2U	30	10	FRN010E1-2U	40	15	FRN015E1-2U	50	20	FRN020E1-2U	75	125	Three-phase 460 V	1/2	FRNF50E1-4U	5	5	1	FRN001E1-4U	2	FRN002E1-4U	3	FRN003E1-4U	5	FRN005E1-4U	10	20	7.5	FRN007E1-4U	15	30	10	FRN010E1-4U	20	40	15	FRN015E1-4U	30	50	20	FRN020E1-4U	40	60	Single-phase 230 V	1/8	FRNF12E1-7U	5	5	1/4	FRNF25E1-7U	1/2	FRNF50E1-7U	1	FRN001E1-7U	10	15	2	FRN002E1-7U	15	20	3	FRN003E1-7U	20	30
Input power supply	Nominal applied motor (HP)	Inverter type				Rated current of MCCB and GFCI (A)																																																																																									
			w/ DCR	w/o DCR																																																																																											
Three-phase 230 V	1/8	FRNF12E1-2U	5	5																																																																																											
	1/4	FRNF25E1-2U																																																																																													
	1/2	FRNF50E1-2U																																																																																													
	1	FRN001E1-2U																																																																																													
	2	FRN002E1-2U	10	10																																																																																											
	3	FRN003E1-2U		15																																																																																											
	5	FRN005E1-2U		20																																																																																											
	7.5	FRN007E1-2U		30																																																																																											
	10	FRN010E1-2U		40																																																																																											
	15	FRN015E1-2U		50																																																																																											
20	FRN020E1-2U	75	125																																																																																												
Three-phase 460 V	1/2	FRNF50E1-4U	5	5																																																																																											
	1	FRN001E1-4U																																																																																													
	2	FRN002E1-4U																																																																																													
	3	FRN003E1-4U																																																																																													
	5	FRN005E1-4U	10	20																																																																																											
	7.5	FRN007E1-4U	15	30																																																																																											
	10	FRN010E1-4U	20	40																																																																																											
	15	FRN015E1-4U	30	50																																																																																											
20	FRN020E1-4U	40	60																																																																																												
Single-phase 230 V	1/8	FRNF12E1-7U	5	5																																																																																											
	1/4	FRNF25E1-7U																																																																																													
	1/2	FRNF50E1-7U																																																																																													
	1	FRN001E1-7U	10	15																																																																																											
	2	FRN002E1-7U	15	20																																																																																											
3	FRN003E1-7U	20	30																																																																																												

	Name of peripheral equipment	Function and application
Main peripheral equipment	Magnetic contactor (MC)	<p>An MC can be used at both the power input (primary) and output (secondary) sides of the inverter. At each side, the MC works as described below. When inserted in the output circuit of the inverter, an MC can also switch the motor drive power supply between the inverter output and commercial power lines.</p> <p>■ At the power supply (primary) side</p> <p>Insert an MC in the power supply side of the inverter in order to:</p> <ol style="list-style-type: none"> <li>1) Forcibly cut off the inverter from the power supply (generally, commercial/factory power lines) with the protection function built into the inverter, or with the terminal signal line.</li> <li>2) Stop the inverter operation in an emergency when the inverter cannot interpret the stop command due to internal/external circuit failures.</li> <li>3) Cut off the inverter from the power supply when the MCCB inserted in the power supply side cannot cut it off for maintenance or inspection purpose. If you are to use the MC for this purpose only, it is recommended that you use an MC capable of turning the MC ON/OFF manually.</li> </ol> <p><b>Note:</b> When your system requires the motor(s) driven by the inverter to be started/stopped with the MC, the frequency of the starting/stopping operation should be once or less per hour. The more frequent the operation, the shorter operation life of the MC and capacitor/s used in the DC link bus due to thermal fatigue caused by the frequent charging of the current flow. If this is not necessary, start/stop the motor with the terminal commands <i>FWD/REV</i> or with the keypad.</p> <p>■ At the output (secondary) side</p> <p>Prevent externally turned-around current from being applied to the inverter power output terminals (U, V, and W) unexpectedly. An MC should be used, for example, if a circuit that switches the motor driving source between the inverter output and commercial/factory power lines is connected to the inverter.</p> <p><b>Note:</b> As application of high voltage external current to the inverter's output side may break the IGBTs, MCs should be used in the power control system circuits to switch the motor drive power supply to the commercial/factory power lines after the motor has come to a complete stop. Also ensure that voltage is never mistakenly applied to the inverter output terminals due to unexpected timer operation, or similar.</p> <p>■ Driving the motor using commercial power lines</p> <p>MCs can also be used to switch the power supply of the motor driven by the inverter to a commercial power supply.</p>

	Name of option	Function and application
Main option	DC reactors (DCRs)	<p>A DCR is mainly used for power supply matching and for input power factor correction (for reduction of harmonics).</p> <ol style="list-style-type: none"> <li>For power supply matching <ul style="list-style-type: none"> <li>Use a DCR when the capacity of a power supply transformer exceeds 500 kVA. In this case, the percentage-reactance of the power supply decreases, and harmonic components and their peak levels increase. These factors may break rectifiers or capacitors in the converter section of inverter, or decrease the capacitance of the capacitor (which can shorten the inverter's service life).</li> <li>Also use a DCR when there are thyristor-driven loads or when phase-advancing capacitors are being turned ON/OFF.</li> </ul> </li> <li>For input power factor correction (reduction of harmonics) <p>Generally a capacitor is used to correct the power factor of the load, however, it cannot be used in a system that includes an inverter. Using a DCR increases the reactance of inverter's power supply so as to decrease harmonic components on the power supply lines and correct the power factor of inverter. Using a DCR reforms the input power factor to approximately 90 to 95%.</p> <p><b>Note:</b> At the time of shipping, a jumper bar is connected across the terminals P1 and P (+) on the terminal block. Remove the jumper bar when connecting a DCR.</p> </li> </ol>
	Output circuit filters (OFLs)	<p>Include an OFL in the inverter power output (secondary) circuit to:</p> <ol style="list-style-type: none"> <li>Suppress the surge voltage at motor terminal <p>This protects the motor from insulation damage caused by the application of high surge voltage.</p> </li> <li>Suppress leakage current from the power output lines (due to harmonic components) <p>This reduces the leakage current when the motor is hooked by long power feed lines. It is recommended that the length of the power feed line be kept to less than 1300ft (400 m).</p> </li> <li>Minimize emission and/or induction noise issued from the power output lines <p>OFLs are effective in reducing noise from long power feed lines, such as those used in plants, etc.</p> <p><b>Note:</b> Use an output circuit (secondary) filter of OFL-□□□-□A.</p> </li> </ol>
	Zero-phase reactors for reducing radio frequency noise (ACL)	<p>An ACL is used to reduce radio noise emitted by the inverter. An ACL suppresses the outflow of high frequency noise caused by switching operation for the power supply (primary) lines inside the inverter. Pass the power supply lines together through the ACL for 4 turns (coiled 3 times). Use 4 ACLs and let the power supply lines pass through them when the sizes of the power supply lines are large.</p> <p>If wiring length between the inverter and motor is less than 66ft (20 m), insert an ACL to the power supply (primary) lines; if it is more than 66ft (20 m), insert it to the power output (secondary) lines of the inverter.</p>
	AC Reactor (ACR)	<ul style="list-style-type: none"> <li>This optional feature must be connected to the primary side (commercial power supply side) of the inverter, when the inter-phase unbalance factor of the commercial power supply is 2% to 3%. <math display="block">\text{Voltage unbalance (\%)} = \frac{\text{Max. voltage (V)} - \text{Min. voltage (V)}}{\text{Three-phase average voltage (V)}} \times 67</math> <p>In case the inter-phase unbalance factor of the commercial power supply exceeds 3%, you would need to take other measures such as increasing the capacity of the inverter. Consult your Fuji Electric representative.</p> </li> <li>In a DC link bus system (using terminals [P (+)] and [N (-)]), the AC reactor protects the inverter against damage caused by unbalance in current.</li> </ul>
	Braking resistors (DBRs)	<p>A braking resistor converts regenerative energy generated from deceleration of the motor and converts it to heat for consumption. Use of a braking resistor results in improved deceleration performance of the inverter.</p>

	Name of option	Function and application
Options for Operation and Communications	External potentiometer for frequency commands	An external potentiometer may be used to set the drive frequency. Connect the potentiometer to control signal terminals [11] to [13] of the inverter.
	Multi-function keypad	Allows you to monitor the status of the inverter including voltage, current, and input power, as well as to set various parameters in a conversational mode. Equipped with a liquid crystal display (LCD). Also allows you to copy function code data from one FRENIC-Multi inverter to another.
	Extension cable for remote keypad operation	The extension cable connects the RS-485 communications port (standard) with a keypad or an RS-485–USB converter. Three lengths are available: 16.4ft (5 m), 9.8ft (3 m) and 3.3ft (1 m)
	RS-485 Communications card	This makes communication to a PLC or personal computer system easy. (Option) This has a pair of RJ-45 connectors that acts as a transfer port for a multidrop network configuration without using a branch adapter.
	RS-485–USB converter	A converter that allows connection of an RS-485 communications port to a USB port on a PC.
	Inverter support loader software	Inverter support loader software, Windows GUI (Graphics User Interface) based, that makes setting of function codes easy.
	Other peripheral equipment	Surge absorbers
Surge killers		A surge killer eliminates surge currents induced by lightning and noise from the power supply lines. Use of a surge killer is effective in preventing the electronic equipment, including inverters, from damage or malfunctioning caused by such surges and/or noise.
Arresters		An arrester suppresses surge currents and noise invaded from the power supply lines. Use of an arrester is effective in preventing electronic equipment, including inverters, from damage or malfunctioning caused by such surges and/or noise.
Frequency meter		Displays the frequency in accordance with signal output from the inverter.
Other options	Panel-mount adapter	FRENIC-Multi series of inverters can be installed to your system panel or equipment using mounting adapters which utilize the mounting holes used for conventional inverters of FVR-E11S series. (Three-phase 230 V: 1/8 to 1 and 5 HP, Three-phase 460 V: 5 HP, Single-phase 230 V: 1/8 to 1/2 and 3 HP)
	Mounting adapter for external cooling	This adapter allows you to mount your FRENIC-Multi series of inverters on the panel in such a way that the heat sink assembly may be exposed to the outside. Using this adapter greatly reduces heat radiated or spread inside your panel. Applicable only to inverters with a capacity of 7.5 to 20 HP.

## Chapter 10 COMPLIANCE WITH STANDARDS

### 10.1 Compliance with UL Standards and Canadian Standards (cUL certification)

#### 10.1.1 General

Originally, the UL standards were established by Underwriters Laboratories, Inc. as private criteria for inspections/investigations pertaining to fire/accident insurance in the USA. Later, these standards were authorized as the official standards to protect operators, service personnel and the general populace from fires and other accidents in the USA.

cUL certification means that UL has given certification for products to clear CSA Standards. cUL certified products are equivalent to those compliant with CSA Standards.

#### 10.1.2 Considerations when using FRENIC-Multi in systems to be certified by UL and cUL

If you want to use the FRENIC-Multi series of inverters as a part of UL Standards or CSA Standards (cUL certified) certified product, refer to the related guidelines described on page viii.

### 10.2 Compliance with European Standards

The CE marking on Fuji products indicates that they comply with the essential requirements of the Electromagnetic Compatibility (EMC) Directive 89/336/EEC and Low Voltage Directive 73/23/EEC issued by the Council of the European Communities.

If connected with a specified external EMC filter, Fuji inverters that bear a CE marking but have no built-in EMC filter become compliant with these EMC Directives.

Inverters that bear a CE marking are compliant with the Low Voltage Directive.

#### The products comply with the following standards:

Low Voltage Directive EN50178: 1997

EMC Directives EN61800-3: 2004

Immunity: Second environment (Industrial)

Emission: See below.

	EMC filter	Capacity of inverter		
		3 HP or below	5 HP	7.5 HP or above
Three-phase 230 V class series	External	Category C2		
	Built-in	Category C2	Category C3	
Three-phase 460 V class series	External	Category C3		
	Built-in	Category C2		Category C3
Single-phase 230 V class series	External	Category C3	—	
	Built-in	Category C2	—	

#### CAUTION

When you use FRENIC-Multi inverters categorized as "Category C2" of the EN61800-3 in a domestic environment, you may need to take appropriate countermeasures to reduce or eliminate any noise emitted from these inverters.

FRENIC-Multi inverters categorized as "Category C3" of the EN61800-3 are not designed for use in a domestic environment. These inverters may interfere with the operations of home appliances or office equipment due to noise emitted from them.

## 10.3 Compliance with EMC Standards

### 10.3.1 General

The CE marking on inverters does not ensure that the entire equipment including our CE-marked products is compliant with the EMC Directive. Therefore, CE marking for the equipment shall be the responsibility of the equipment manufacturer. For this reason, Fuji's CE mark is indicated under the condition that the product shall be used within equipment meeting all requirements for the relevant Directives. Instrumentation of such equipment shall be the responsibility of the equipment manufacturer.

Generally, machinery or equipment includes not only our products but other devices as well. Manufacturers, therefore, shall design the whole system to be compliant with the relevant Directives.

In addition, to satisfy the requirements noted above, use a Fuji FRENIC inverter in connection with an EMC-compliant filter (optional feature) in accordance with the instructions contained in this instruction manual. Installing the inverter(s) in a metal enclosure may be necessary, depending upon the operating environment of the equipment that the inverter is to be used with.

 Our EMC compliance test is performed under the following conditions.

- Motor Sound (carrier frequency) (F26): 15 kHz
- Wiring length (of the shielded cable) between the inverter and motor: 33ft (10 m)

### 10.3.2 Recommended installation procedure

To make the machinery or equipment fully compliant with the EMC Directive, have certified technicians wire the motor and inverter in strict accordance with the procedure described below.

■ In the case of EMC filter built-in type of inverters with a capacity of 5 HP or below

- 1) Mount the EMC grounding flange (that comes with the inverter) to the inverter with screws in order to ground the wire shield(s). (See Figure 10.1.)

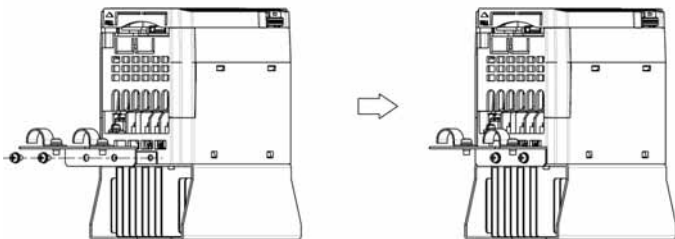

Figure 10.1 Attaching the EMC Grounding Flange

- 2) Use shielded wires for the motor cable and route it as short as possible. Firmly clamp the wire shield to the flange to ground it. Further, connect the wire shield electrically to the grounding terminal of motor. (See Figure 10.2.)
- 3) Use shielded wire for connection around the control terminals of the inverter and also for connection of the signal cable of an RS-485 Communications. As with the motor, clamp the shield wire firmly to a grounded plate. (See Figure 10.2.)

- 4) In the case of FRN001E1E-7U, motor cable shall be wired through the ring core (that comes with the inverter), and the ring core shall be fixed by the EMC grounding flange.

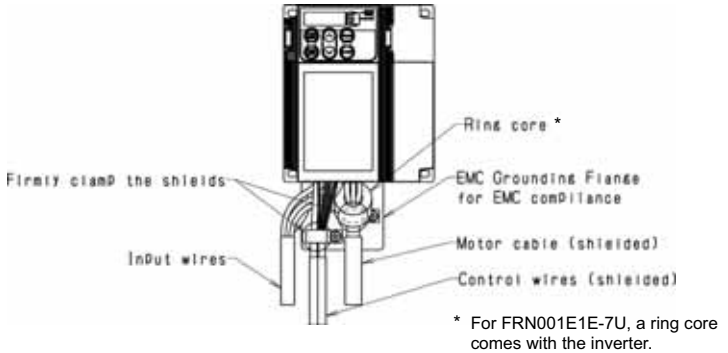
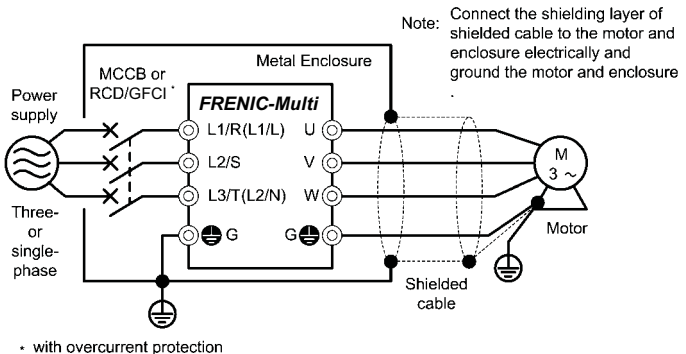

Figure 10.2 Connecting Shielded Cables

- 5) If noise from the inverter exceeds the permissible level, enclose the inverter and its peripherals within a metal enclosure as shown in Figure 10.3.



• with overcurrent protection

Figure 10.3 Installing the EMC Filter Built-in Type of Inverters into a Metal Enclosure



■ In the case of inverters with an external EMC-compliant filter (optional)

- 1) Install the inverter and the filter on a grounded metal plate. Use a shielded cable also for connection of the motor. Make the cables as short as possible. Connect the shield wire firmly to the metal plate. Also connect the shield wire electrically to the grounding terminal of the motor.  
For the inverters from 7.5 to 20 HP, install them in a metal enclosure to comply with the EMC directive.
- 2) Use shielded wire for connection around the control terminals of the inverter and also for connection of the signal cable of an RS-485 Communications Card. As with the motor, clamp the shield wire firmly to a grounded plate.
- 3) If noise from the inverter exceeds the permissible level, enclose the inverter and its peripherals within a metal enclosure as shown in Figure 10.4.

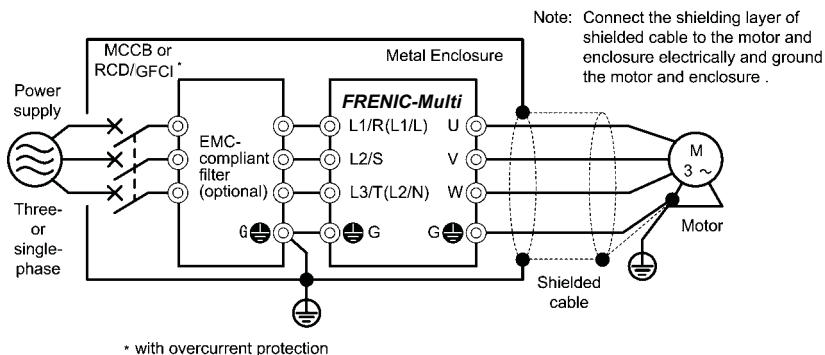

Figure 10.4 Installing the Inverter with an External EMC-compliant Filter (Optional) into a Metal Enclosure

### 10.3.3 Leakage current from EMC-filter built-in type inverters or inverters with an external EMC-complaint filter (optional)

Table 10.1 Leakage Current from EMC Filter Built-in Type Inverter

Input power	Inverter type	Leakage current (mA) *1)	
		Normal	Worst *2)
Three-phase 230 V	FRNF12E1E-2U	7.5	7.5
	FRNF25E1E-2U		
	FRNF50E1E-2U		
	FRN001E1E-2U		
	FRN002E1E-2U	13.0	20.0
	FRN003E1E-2U		
	FRN005E1E-2U		
	FRN007E1E-2U	21.0	21.0
	FRN010E1E-2U		
	FRN015E1E-2U		
FRN020E1E-2U			
Three-phase 460 V	FRNF50E1E-4U	5.4	33.0
	FRN001E1E-4U		
	FRN002E1E-4U		
	FRN003E1E-4U	3.8	25.0
	FRN005E1E-4U		
	FRN007E1E-4U	3.8	11.7
	FRN010E1E-4U		
	FRN015E1E-4U	6.8	22.3
FRN020E1E-4U			
Single-phase 230 V	FRNF12E1E-7U	8.3	8.3
	FRNF25E1E-7U		
	FRNF50E1E-7U		
	FRN001E1E-7U		
	FRN002E1E-7U	4.1	8.2
	FRN003E1E-7U		

\*1) The values are calculated assuming the power supplies of three-phase 240 V (50 Hz), three-phase 400 V (50 Hz), and single-phase 230 V (50 Hz).

\*2) The worst condition includes a phase loss in the supply line.

Table 10.2 Leakage Current from Inverters with an External EMC-complaint Filter (Optional)

Input power	Inverter type	Filter type	Leakage current (mA) *1)	
			Normal	Worst *2)
Three-phase 230 V	FRNF12E1S-2U	EFL-0.75E11-2	3.0	3.0
	FRNF25E1S-2U			
	FRNF50E1S-2U			
	FRN001E1S-2U			
	FRN002E1S-2U	EFL-4.0E11-2	3.0	3.0
	FRN003E1S-2U			
	FRN005E1S-2U			
	FRN007E1S-2U	EFL-7.5E11-2	11	11
	FRN010E1S-2U	EFL-15SP-2	20	20
	FRN015E1S-2U			
FRN020E1S-2U				
Three-phase 460 V	FRNF50E1S-4U	15TDHS84	4.0	27.0
	FRN001E1S-4U			
	FRN002E1S-4U			
	FRN003E1S-4U			
	FRN005E1S-4U			
	FRN007E1S-4U	FN3011-30-61	0.4	3.1
	FRN010E1S-4U	FN301150-62	0.4	3.1
	FRN015E1S-4U			
	FRN020E1S-4U			
Single-phase 230 V	FRNF12E1S-7U	30DKCS5	1.0	1.8
	FRNF25E1S-7U			
	FRNF50E1S-7U			
	FRN001E1S-7U			
	FRN002E1S-7U			
	FRN003E1S-7U			

\*1) The values are calculated assuming the power supplies of three-phase 240 V (50 Hz), three-phase 400 V (50 Hz), and single-phase 230 V (50 Hz).

\*2) The worst condition includes a phase loss in the supply line.

## 10.4 Harmonic Component Regulation in the EU

### 10.4.1 General comments

When you use general-purpose industrial inverters in the EU, the harmonics emitted from the inverter to power lines are strictly regulated as stated below.

If an inverter whose rated input is 1kW or less is connected to public low-voltage power supply, it is regulated by the harmonics emission regulations from inverters to power lines (with the exception of industrial low-voltage power lines). Refer to Figure 10.5 below for details.

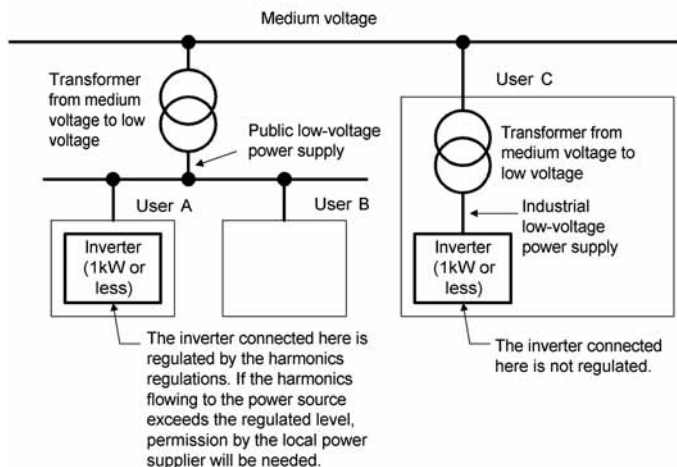

Figure 10.5 Power Source and Regulation

## 10.4.2 Compliance with the harmonic component regulation

Table 10.3 Compliance with Harmonic Component Regulation

Power supply voltage	Inverter type	w/o DC reactor	w/ DC reactor	Applicable DC reactor type
Three-phase 230 V	FRNF12E1 ■-2U	√ *	√ *	DCR2-0.2
	FRNF25E1 ■-2U	√ *	√ *	DCR2-0.2
	FRNF50E1 ■-2U	√ *	√ *	DCR2-0.4
	FRN001E1 ■-2U	√ *	√ *	DCR2-0.75
Three-phase 460 V	FRNF50E1 ■-4U	—	√	DCR4-0.4
	FRN001E1 ■-4U	—	√	DCR4-0.75
Single-phase 230 V	FRNF12E1 ■-7U	—	√	DCR2-0.2
	FRNF25E1 ■-7U	—	√	DCR2-0.4
	FRNF50E1 ■-7U	—	√	DCR2-0.75
	FRN001E1 ■-7U	—	—	DCR2-1.5

\* When supplying three-phase 230 VAC power stepped down from a three-phase 460 VAC power line using a transformer, the level of harmonic flow from the 460 VAC line will be regulated.

**Note 1)** A box (■) in the above table replaces S or E depending on the enclosure.

**Note 2)** Inverter types marked with √ in the table above are compliant with the EN61000-3-2 (+A14), so they may be connected to public low-voltage power supply unconditionally.

Conditions apply when connecting models marked with "—". If you want to connect them to public low-voltage power supply, you need to obtain permission from the local electric power supplier. In general, you will need to provide the supplier with the harmonics current data of the inverter. To obtain the data, consult your Fuji Electric representative.

## 10.5 Compliance with the Low Voltage Directive in the EU

### 10.5.1 General

General-purpose inverters are regulated by the Low Voltage Directive in the EU. Fuji Electric states that all our inverters with CE or TÜV mark are compliant with the Low Voltage Directive.

### 10.5.2 Points for consideration when using the FRENIC-Multi series in a system to be certified by the Low Voltage Directive in the EU

If you want to use the FRENIC-Multi series of inverters in systems/equipment in the EU, refer to the guidelines on page vi.

MEMO

## High Performance Compact Inverter

# ***FRENIC-Multi***

---

### **Instruction manual**

First Edition, June 2007

Fuji Electric FA Components & Systems Co., Ltd.

Fuji Electric Corp. of America

---

The purpose of this instruction manual is to provide accurate information in handling, setting up and operating of the FRENIC-Multi series of inverters. Please feel free to send your comments regarding any errors or omissions you may have found, or any suggestions you may have for generally improving the manual.

In no event will Fuji Electric FA Components & Systems Co., Ltd. be liable for any direct or indirect damages resulting from the application of the information in this manual.

---

**Fuji Electric FA Components & Systems Co., Ltd.**  
**Fuji Electric Corp. of America**

---

2007-07(G07/G07)05CM